

Operating Instruction

Frequency Inverter

Series KFU A2- / A4-

0,09 up to 7,5 kW – 230 V – KFU A2-
0,25 up to 11 kW – 400 V – KFU A4-

1	General information about the documentation	5
1.1	This document.....	6
1.2	Warranty and liability	6
1.3	Obligation.....	7
1.4	Copyright.....	7
1.5	Storage.....	7
2	General safety instructions and information on use.....	8
2.1	Terminology	8
2.2	Designated use.....	9
2.3	Misuse	9
2.3.1	Explosion protection	9
2.4	Residual risks	10
2.5	Safety and warning signs at frequency inverter.....	10
2.6	Warning information and symbols used in the user manual	11
2.6.1	Hazard classes.....	11
2.6.2	Hazard symbols	11
2.6.3	Prohibition signs	11
2.6.4	Personal safety equipment	11
2.6.5	Recycling	11
2.6.6	Grounding symbol.....	12
2.6.7	ESD symbol.....	12
2.6.8	Information signs	12
2.7	Directives and guidelines to be adhered to by the operator.....	13
2.8	Operator's general plant documentation	13
2.9	Operator's/operating staff's responsibilities	13
2.9.1	Selection and qualification of staff	13
2.9.2	General work safety	13
2.10	Organizational measures	14
2.10.1	General.....	14
2.10.2	Use in combination with third-party products.....	14
2.10.3	Transport and Storage	14
2.10.4	Handling and installation	14
2.10.5	Electrical connections.....	14
2.10.6	Safe operation	15
2.10.7	Maintenance and service/troubleshooting	16
2.10.8	Final decommissioning	16
3	Device overview	17
3.1	Inverter type and warning signs on the device	17
3.2	Type designation	18
3.3	Software Version Identification	19
3.4	Overview of components and connection terminals.....	19
3.5	Number of control terminals.....	20
4	Mechanical Installation.....	21
4.1	Safety	21
4.2	Installation.....	21
4.2.1	Size 1 (3~:0.18 kW to 2.2 kW; 1~: 0.09 kW to 1.1 kW).....	22
4.2.2	Size 2 (3~: 3.0 kW to 5.5 kW; 1~: 1.5 kW to 2.2 kW)	23
4.2.3	Size 3 (5.5 kW to 11.0 kW)	24

5 Electrical Installation	25
5.1 Safety	25
5.2 Electrical connections overview.....	26
5.3 EMC Information	26
5.4 Dimensioning of conductor cross-section.....	28
5.4.1 Typical cross-sections	28
5.5 Mains Connection	30
5.6 Motor Connection.....	32
5.6.1 Length of motor cables, without filter	33
5.6.2 Motor cable length, with output filter du/dt	33
5.6.3 Motor cable length, with sinus filter	34
5.6.4 Group drive	34
5.6.5 Brake resistor	34
5.7 Control terminals Standard connection	36
5.7.1 Circuit for control via control terminals	39
5.7.2 Circuit for control via operator panel	39
5.7.3 Further setting options for control terminals	40
5.7.4 Evaluation logic of digital inputs	41
5.7.5 Overview of voltage inputs and outputs	42
5.7.6 External DC 24 V power supply.....	42
5.7.7 Installation notes according to UL508c.....	43
6 Commissioning	44
6.1 Operator panel	45
6.1.1 Menus.....	45
6.1.2 Motor control with operator panel	49
6.1.3 Set a parameter to the factory setting.....	52
6.1.4 Restrict the scope of operation	53
6.2 First commissioning	53
6.2.1 Overview.....	53
6.2.2 Start first commissioning of an asynchronous motor	54
6.2.3 Start first commissioning of a synchronous motor	57
6.2.4 Status messages during commissioning (SS.....)	61
6.2.5 Warnings during commissioning (SA.....)	61
6.2.6 Error messages during commissioning (SF.....)	63
6.2.7 Check direction of rotation	64
6.2.8 Selection of actual value display	65
6.2.9 Commissioning without Setup.....	65
6.2.10 Optional Optimization of motor characteristics	66
6.3 Commissioning of a communication interface.....	69
6.3.1 CANopen.....	70
6.3.2 Profibus	70
6.3.3 Systembus	71
6.3.4 Modbus.....	72
6.3.5 VABus.....	73
6.3.6 TCP/IP	74
6.4 After first commissioning	75
6.5 Typical functions	86
6.6 Error Acknowledgment via keypad	92
6.7 Applications.....	93
6.7.1 Pump.....	93
6.7.2 Fan.....	94
6.7.3 Fan or pump with closed control loop.....	95
6.7.4 Fan for heating, ventilation, air conditioning system.....	97
6.7.5 Conveying plant.....	98

6.7.6	Compressor	99
6.7.7	Travel applications	100
6.7.8	Torque control	101
6.8	Set-up via the Communication Interface	102
7	Parameter descriptions	104
7.1	Inverter Data	104
7.1.1	Control level	105
7.1.2	Configuration	105
7.1.3	Set password	107
7.1.4	Programming	107
7.2	Machine data	108
7.2.1	Rated motor parameters	108
7.2.2	Further motor parameters	109
7.2.3	Device test	112
7.3	Operational Behaviour	116
7.3.1	Control	116
7.3.2	Starting behaviour	118
7.3.3	Stopping behaviour	122
7.3.4	Auto start	124
7.3.5	Flying Start	124
7.3.6	Direct current brake	126
7.3.7	Positioning	127
7.4	Error and warning behaviour	130
7.4.1	Overload Ixt	130
7.4.2	Temperature	130
7.4.3	Controller status	131
7.4.4	Frequency switch-off limit	131
7.4.5	External error	132
7.4.6	Motor temperature	132
7.4.7	Phase failure	136
7.4.8	Automatic Error Acknowledgment	137
7.5	Reference Values	137
7.5.1	Reference frequency channel	137
7.5.2	Reference percentage channel	147
7.5.3	Motor potentiometer	151
7.5.4	Electronic gear	159
7.6	Control inputs and outputs	164
7.6.1	Multifunction input MFI1	164
7.6.2	Multifunction input MFI2	170
7.6.3	Multifunction output MFO1	178
7.6.4	Digital input/output IN3D/OUT3D	182
7.6.5	Digital outputs	183
7.6.6	Digital inputs	192
7.6.7	Input PWM/repetition frequency/pulse train	203
7.7	V/f characteristic	207
7.8	Linear V/f characteristic	207
7.8.1	Dynamic voltage pre-control	208
7.9	Control functions	208
7.9.1	Intelligent current limits	208
7.9.2	Voltage controller	210
7.9.3	PID controller (technology controller)	216
7.9.4	Functions of sensorless control	223
7.9.5	Functions of field-orientated control	225
7.9.6	Real-time tuning (optimizing motor parameters in operation)	236

7.10 Special functions	236
7.10.1 Pulse width modulation	236
7.10.2 Fan	237
7.10.3 Standby mode and energy saving function	238
7.10.4 Brake chopper and brake resistor	238
7.10.5 Motor chopper	240
7.10.6 Motor Protection	242
7.10.7 V-belt monitoring	247
7.10.8 Traverse function.....	247
7.10.9 System data	250
7.10.10 Service interval monitoring.....	250
7.10.11 Copy parameters.....	250
7.10.12 Converter Profibus from/to Internal Notation	253
8 Energy saving	254
8.1 Energy saving function	254
8.2 Quadratic V/f characteristic	256
8.3 Standby mode	257
8.4 Further energy saving options	259
9 Actual values	261
9.1 Actual values of frequency inverter	261
9.1.1 STO Status.....	262
9.2 Actual values of machine	263
9.3 Actual values of the system	264
9.3.1 Actual system value	264
9.4 Actual value memory	264
9.5 Actual values of the CAN system bus	265
9.6 Actual values CANopen	266
9.7 Actual values Modbus and VABus	266
9.8 Actual values Ethernet	266
10 Service	267
10.1 Safety	267
10.2 Regular service work	267
10.3 Monitoring of service interval	269
10.3.1 DC-link.....	269
10.3.2 Fan.....	270
10.3.3 Reset service interval	271
11 Technical data	272
11.1 General technical data	272
11.2 Device data	272
11.2.1 KFU A2 (3~:0.18 to 0.55 kW, 1~:0.09 to 0.25 kW, 230 V)	274
11.2.2 KFU A2 (3~:0.75 to 2.2 kW, 1~:0.37 to 1.1 kW, 230 V).....	275
11.2.3 KFU A2 (3~:3.0 to 4.0 kW, 1~:1.5 to 2.2 kW, 230 V)	276
11.2.4 KFU A2 (3~:5.5 to 7.5 kW, 1~:3.0 kW, 230 V).....	277
11.2.5 KFU A4 (0.25 to 2.2 kW, 400 V)	278
11.2.6 KFU A4 (3.0 to 11.0 kW, 400 V)	279
11.2.7 Increase of switching frequency	280

11.3 Control electronics	281
11.4 Operation diagrams	283
12 Options	285
12.1 Safety	285
12.2 Shield sheets	285
12.2.1 Shield sheet for control cables	285
12.2.2 Shield sheet for motor cables	287
12.3 Brake resistor	291
12.3.1 230 V devices	291
12.3.2 400 V devices	292
12.4 Line choke	292
12.4.1 1x230 V connection	293
12.4.2 3x230 V connection	294
12.4.3 3x400 V connection	294
12.4.4 Dimensions	295
12.5 Input filter	296
12.5.1 Footprint filter	296
12.5.2 Booktype filter	298
12.5.3 Interference suppression class.....	299
12.6 Communication module	303
12.7 USB adaptor	303
12.8 Resource pack.....	303
12.9 Assembly variants.....	304
12.9.1 Feed-through assembly (This assembly set is not included in delivery.).....	304
12.9.2 Cold Plate (This assembly set is not included in delivery.)	310
12.9.3 Vibration-proof (This assembly set is not included in delivery.)	317
12.9.4 DIN rail (This assembly set is not included in delivery.).....	319
13 Error protocol	321
13.1 Error list	321
13.1.1 Error messages.....	321
13.2 Error environment.....	324
13.3 Troubleshooting	326
14 Operational and error diagnosis	330
14.1 Status of digital signals	330
14.2 Controller status	330
14.3 Warning status and warning status application	331
15 Parameter list.....	334
15.1 Actual values (Menu Actual)	334
15.2 Parameters (Menu PARA)	339
Index	352

1 General information about the documentation



For the series of devices AGL (KFU) is for the safety-related commissioning and operation to be complied with the following documentation:

- This Operating instructions
- Application manual "Functional Safety KFU "

For better clarity, the documentation is structured according to the customer-specific requirements made on the frequency inverter.

QUICK START GUIDE

The Quick Start Guide describes the basic steps required for mechanical and electrical installation of the frequency inverter. The guided commissioning supports you in the selection of necessary parameters and the configuration of the frequency inverter by the software.

OPERATING INSTRUCTIONS

The Operating Instructions describe and document all functions of the frequency inverter. The parameters required for adapting the frequency inverter to specific applications as well as the wide range of additional functions are described in detail.

APPLICATION MANUAL

The application manual supplements the documentation for purposeful installation and commissioning of the frequency inverter. Information on various subjects connected with the use of the frequency inverter is described specific to the application.

Installation instructions

The installation manual describes the installation and use of devices, complementing the "Quick Start Guide" and the user manual.

The following instructions are available for the *KFU* series:

Operating Instructions <i>KFU</i>	Functions of the frequency inverter.
Quick Start Guide <i>KFU</i>	Installation and commissioning. Delivered with the device.
Application manual "Functional Safety".	Description of the Functions and usage of the integrated Functional Safety.
Application manuals Communication	<p>Communication via the RS485 interface at terminal X21: Manuals Modbus and VABus.</p> <p>Communication via the control terminals X12.5 and X12.6: system bus and CANopen®.</p> <p>CM-232/CM-485: Manuals Modbus and VABus. CM-CAN: Manuals system bus and CANopen®. CM-PDPV1: Manual Profibus-DP-V1. CM-VABus/TCP: Manual for Ethernet Module CM-VABus/TCP CM-Modbus/TCP: Manual for Ethernet Module CM-Modbus/TCP CM-EtherCAT®: Manual for Ethernet Module CM-EtherCAT® CM-ProfiNet: Manual for Ethernet Module CM-ProfiNet</p>
Application manual PLC	Logic linking of digital signals. Functions for analog signals such as comparisons and mathematical functions. Graphic functional block programming.

The products for CANopen® communication comply with the specifications of the user organization CiA® (CAN in Automation).

The products for EtherCAT® communication comply with the specifications of the user organization ETG (EtherCAT Technology Group).

1.1 This document

The present user manual complements the "Quick Start Guide" for the frequency inverters of the KFU A2 and KFU A4 device series.

The user manual contains important information on the installation and use in its specified application range. Compliance with this user manual contributes to avoiding risks, minimizing repair cost and downtimes and increasing the reliability and service life of the frequency inverter.

For this reason, make sure you read the user manual carefully.

WARNING



Compliance with the documentation is required to ensure safe operation of the frequency inverter. KÜENLE ANTRIEBSSYSTEME GmbH shall not be held liable for any damage caused by any non-compliance with the documentation.



In case any problems occur which are not covered by the documentation sufficiently, please contact the manufacturer.

1.2 Warranty and liability

KÜENLE ANTRIEBSSYSTEME GmbH would like to point out that the contents of this user manual do not form part of any previous or existing agreement, assurance or legal relationship. Neither are they intended to supplement or replace such agreements, assurances or legal relationships. Any obligations of the manufacturer shall solely be based on the relevant purchase agreement which also includes the complete and solely valid warranty stipulations. These contractual warranty provisions are neither extended nor limited by the specifications contained in this documentation.

The manufacturer reserves the right to correct or amend the specifications, product information and omissions in these operating instructions without notice. The manufacturer shall not be liable for any damage, injuries or costs which may be caused by the aforementioned reasons.

In addition to that, KÜENLE ANTRIEBSSYSTEME GmbH excludes any warranty/liability claims for any personal and/or material damage if such damage is due to one or more of the following causes:

- inappropriate use of the frequency inverter,
- non-compliance with the instructions, warnings and prohibitions contained in the documentation,
- unauthorized modifications of the solar inverter,
- insufficient monitoring of parts of the machine/plant which are subject to wear,
- repair work at the machine/plant not carried out properly or in time,
- catastrophes by external impact and Force Majeure.

1.3 Obligation

This user manual must be read before commissioning and complied with. Anybody entrusted with tasks in connection with the

- transport,
- assembly,
- installation of the frequency inverter and
- operation of the frequency inverter

must have read and understood the user manual and, in particular, the safety instructions in order to prevent personal and material losses.

1.4 Copyright

In accordance with applicable law against unfair competition, this user manual is a certificate. Any copyrights relating to it shall remain with

KÜENLE ANTRIEBSSYSTEME GmbH

Saarstraße 41-43

71282 Hemmingen

Germany

This user manual is intended for the operator of the frequency inverter. Any disclosure or copying of this document, exploitation and communication of its contents (as hardcopy or electronically) shall be forbidden, unless permitted expressly.

Any non-compliance will constitute an offense against the copyright law dated 09 September 1965, the law against unfair competition and the Civil Code and may result in claims for damages. All rights relating to patent, utility model or design registration reserved.

1.5 Storage

The documentation forms an integral part of the frequency inverter. It must be stored such that it is accessible to operating staff at all times. In case the frequency inverter is sold to other users, this user manual must also be handed over.

2 General safety instructions and information on use

The chapter "General safety instructions and information on use" contains general safety instructions for the Operator and the Operating Staff. At the beginning of certain main chapters, some safety instructions are included which apply to all work described in the relevant chapter. Special work-specific safety instructions are provided before each safety-relevant work step.

2.1 Terminology

According to the documentation, different activities must be performed by certain persons with certain qualifications.

The groups of persons with the required qualification are defined as follows:

Operator

This is the entrepreneur/company who/which operates the frequency inverter and uses it as per the specifications or has it operated by qualified and instructed staff.

Operating staff

The term Operating Staff covers persons instructed by the Operator of the frequency inverter and assigned the task of operating the frequency inverter.

Qualified staff

The term Qualified Staff covers staff who is assigned special tasks by the Operator of the frequency inverter, e.g. installation, maintenance and service/repair and troubleshooting. Based on their qualification and/or know-how, qualified staff must be capable of identifying defects and assessing functions.

Qualified electrician

The term Qualified Electrician covers qualified and trained staff who has special technical know-how and experience with electrical installations. In addition, Qualified Electricians must be familiar with the applicable standards and regulations, they must be able to assess the assigned tasks properly and identify and eliminate potential hazards.

Instructed person

The term Instructed Person covers staff who was instructed and trained about/in the assigned tasks and the potential hazards that might result from inappropriate behaviour. In addition, instructed persons must have been instructed in the required protection provisions, protective measures, the applicable directives, accident prevention regulations as well as the operating conditions and verified their qualification.

Expert

The term Expert covers qualified and trained staff who has special technical know-how and experience relating to frequency inverter. Experts must be familiar with the applicable government work safety directives, accident prevention regulations, guidelines and generally accepted rules of technology in order to assess the operationally safe condition of the frequency inverter.

2.2 Designated use

The frequency inverter is designed according to the state of the art and recognized safety regulations.

The frequency inverters are electrical drive components intended for installation in industrial plants or machines. Commissioning and start of operation is not allowed until it has been verified that the machine meets the requirements of the EC Machinery Directive 2006/42/EC and DIN EN 60204-1.

The frequency inverters meet the requirements of the low voltage directive 2006/95/EEC and DIN EN 61800-5-1. CE-labeling is based on these standards. Responsibility for compliance with the EMC Directive 2004/108/EC lies with the operator. Frequency inverters are only available at specialized dealers and are exclusively intended for commercial use as per EN 61000-3-2.

The safety function STO complies with the requirements of the relevant standards (Cat. 3 / PL d acc. to EN ISO 13849-1, SIL CL 2 acc. to EN 61800-5-2 / EN 62061 / IEC 61508) and can be used in applications up to these safety levels.

No capacitive loads may be connected to the frequency inverter.

The technical data, connection specifications and information on ambient conditions are indicated on the rating plate and in the documentation and must be complied with in any case.

2.3 Misuse

Any use other than that described in "Designated use" shall not be permissible and shall be considered as misuse.

For example, the machine/plant must not be operated

- by un instructed staff,
- while it is not in perfect condition,
- without protection enclosure (e.g. covers),
- without safety equipment or with safety equipment deactivated.

The manufacturer shall not be held liable for any damage resulting from such misuse. The sole risk shall be borne by the operator.

2.3.1 Explosion protection

The frequency inverter is an IP 20 protection class device. For this reason, use of the device in explosive atmospheres is not permitted.

2.4 Residual risks

Residual risks are special hazards involved in handling of the frequency inverter which cannot be eliminated despite the safety-compliant design of the device. Residual risks are not obviously identifiable and can be a potential source of injury or health hazard.

Typical residual hazards include:

Electrical hazard

Danger of contact with energized components due to a defect, opened covers or enclosures or improper working on electrical equipment.

Danger of contact with energized components inside of the frequency inverter if no external disconnection device was installed by the operator.

Electrostatic charging

Touching electronic components bears the risk of electrostatic discharges.

Thermal hazards

Risk of accidents by hot machine/plant surfaces, e.g. heat sink, transformer, fuse or sine filter.

Charged capacitors in DC link

The DC link may have dangerous voltage levels even up to three minutes after shutdown.

Danger of equipment falling down/over, e.g. during transport

Center of gravity is not the middle of the electric cabinet modules.

2.5 Safety and warning signs at frequency inverter

- Comply with all safety instructions and danger information provided on the frequency inverter.
- Safety information and warnings on the frequency inverter must not be removed.

2.6 Warning information and symbols used in the user manual

2.6.1 Hazard classes

The following hazard identifications and symbols are used to mark particularly important information:

	⚠ DANGER
	Identification of immediate threat holding a high risk of death or serious injury if not avoided.





	⚠ WARNING
	Identification of immediate threat holding a medium risk of death or serious injury if not avoided.

	⚠ CAUTION
	Identification of immediate threat holding a low risk of minor or moderate physical injury if not avoided.

NOTICE

Identification of a threat holding a risk of material damage if not avoided.

2.6.2 Hazard symbols

Symbol	Meaning	Symbol	Meaning
	General hazard		Suspended load
	Electrical voltage		Hot surfaces

2.6.3 Prohibition signs

Symbol	Meaning
	No switching; it is forbidden to switch the machine/plant, assembly on

2.6.4 Personal safety equipment

Symbol	Meaning
	Wear body protection

2.6.5 Recycling

Symbol	Meaning
	Recycling, to avoid waste, collect all materials for reuse

2.6.6 Grounding symbol

Symbol	Meaning
	Ground connection

2.6.7 ESD symbol

Symbol	Meaning
	ESD: Electrostatic Discharge (can damage components and assemblies)

2.6.8 Information signs

Symbol	Meaning
	Tips and information making using the frequency inverter easier.

2.7 Directives and guidelines to be adhered to by the operator

The operator must follow the following directives and regulations:

- Ensure that the applicable workplace-related accident prevention regulations as well as other applicable national regulation are accessible to the staff.
- An authorized person must ensure, before using the frequency inverter, that the device is used in compliance with its designated use and that all safety requirements are met.
- Additionally, comply with the applicable laws, regulations and directives of the country in which the frequency inverter is used.
- Any additional guidelines and directives that may be required additionally shall be defined by the operator of the machine/plant considering the operating environment.

2.8 Operator's general plant documentation

- In addition to the user manual, the operator should issue separate internal operating instructions for the frequency inverter. The user manual of the frequency inverter must be included in the user manual of the whole plant.

2.9 Operator's/operating staff's responsibilities

2.9.1 Selection and qualification of staff

- Any work on the frequency inverter may only be carried out by qualified technical staff. The staff must not be under the influence of any drugs. Note the minimum age required by law. Define the staff's responsibility in connection with all work on the frequency inverter clearly.
- Work on the electrical components may only be performed by a qualified electrician according to the applicable rules of electrical engineering.
- The operating staff must be trained for the relevant work to be performed.

2.9.2 General work safety

- In addition to the user manual of the machine/plant, any applicable legal or other regulations relating to accident prevention and environmental protection must be complied with. The staff must be instructed accordingly.
Such regulations and/or requirements may include, for example, handling of hazardous media and materials or provision/use of personal protective equipment.
- In addition to this user manual, issue any additional directives that may be required to meet specific operating requirements, including supervision and reporting requirements, e.g. directives relating to work organization, workflow and employed staff.
- Unless approved of expressly by the manufacturer, do not modify the frequency inverter in any way, including addition of attachments or retrofits.
- Only use the frequency inverter if the rated connection and setup values specified by the manufacturer are met.
- Provide appropriate tools as may be required for performing all work on the frequency inverter properly.

2.10 Organizational measures

2.10.1 General

- Train your staff in the handling and use of the frequency inverter and the machine/plant as well as the risks involved.
- Use of any individual parts or components of the frequency inverter in other parts of the operator's machine/plant is prohibited.
- Optional components for the frequency inverter must be used in accordance with their designated use and in compliance with the relevant documentation.

2.10.2 Use in combination with third-party products

- Please note that KÜENLE ANTRIEBSSYSTEME GmbH will not accept any responsibility for compatibility with third-party products (e.g. motors, cables or filters).
- In order to enable optimum system compatibility, KÜENLE ANTRIEBSSYSTEME GmbH office components facilitating commissioning and providing optimum synchronization of the machine/plant parts in operation.
- If you use the frequency inverter in combination with third-party products, you do this at your own risk.

2.10.3 Transport and Storage

- The frequency inverters must be transported and stored in an appropriate way. During transport and storage the devices must remain in their original packaging.
- The units may only be stored in dry rooms which are protected against dust and moisture and are exposed to little temperature deviations only. The requirements of DIN EN 60721-3-1 for storage, DIN EN 60721-3-2 for transport and labeling on the packaging must be met.
- The duration of storage without connection to the permissible nominal voltage may not exceed one year.

2.10.4 Handling and installation

- Do not commission any damaged or destroyed components.
- Prevent any mechanical overloading of the frequency inverter. Do not bend any components and never change the isolation distances.
- Do not touch any electronic construction elements and contacts. The frequency inverter is equipped with components which are sensitive to electrostatic energy and can be damaged if handled improperly. Any use of damaged or destroyed components will endanger the machine/plant safety and shall be considered as a non-compliance with the applicable standards.
- Only install the frequency inverter in a suitable operating environment. The frequency inverter is exclusively designed for installation in industrial environments.
- If seals are removed from the case, this can result in the warranty becoming null and void.

2.10.5 Electrical connections

- The five safety rules must be complied with.
- Never touch live terminals. The DC link may have dangerous voltage levels even up to three minutes after shutdown.
- When performing any work on/with the frequency inverter, always comply with the applicable national and international regulations/laws on work on electrical equipment/plants of the country when the frequency inverter is used.
- The cables connected to the frequency inverters may not be subjected to high-voltage insulation tests unless appropriate circuitry measures are taken before.
- Only connect the frequency inverter to suitable supply mains.

2.10.5.1 The five safety rules

When working on/in electrical plants, always follow the five safety rules:

1. Isolate
2. Secure to prevent restarting
3. Check isolation
4. Earth and short-circuit,
5. Cover or shield neighboring live parts.

2.10.6 Safe operation

- During operation of the frequency inverter, always comply with the applicable national and international regulations/laws on work on electrical equipment/plants.
- Before commissioning and the start of the operation, make sure to fix all covers and check the terminals. Check the additional monitoring and protective devices according to the applicable national and international safety directives.
- During operation, never open the machine/plant
- Do not connect/disconnect any components/equipment during operation.
- The machine/plant holds high voltage levels during operation, is equipped with rotating parts (fan) and has hot surfaces. Any unauthorized removal of covers, improper use, wrong installation or operation may result in serious injuries or material damage.
- Some components, e.g. the heat sink or brake resistor, may be hot even some time after the machine/plant was shut down. Don't touch any surfaces directly after shutdown. Wear safety gloves where necessary.
- The frequency inverter may hold dangerous voltage levels until the capacitor in the DC link is discharged. Wait for at least 3 minutes after shutdown before starting electrical or mechanical work on the frequency inverter. Even after this waiting time, make sure that the equipment is deenergized in accordance with the safety rules before starting the work.
- In order to avoid accidents or damage, only qualified staff and electricians may carry out the work such as installation, commissioning or setup.
- In the case of a defect of terminals and/or cables, immediately disconnect the frequency inverter from mains supply.
- Persons not familiar with the operation of frequency inverters must not have access to the frequency inverter. Do not bypass nor decommission any protective facilities.
- The frequency inverter may be connected to power supply every 60 s. This must be considered when operating a mains contactor in jog operation mode. For commissioning or after an emergency stop, a non-recurrent, direct restart is permissible.
- After a failure and restoration of the power supply, the motor may start unexpectedly if the Auto Start function is activated.
If staff is endangered, a restart of the motor must be prevented by means of external circuitry.
- Before commissioning and the start of the operation, make sure to fix all covers and check the terminals. Check the additional monitoring and protective devices according to EN 60204 and applicable the safety directives (e.g. Working Machines Act or Accident Prevention Directives).

2.10.7 Maintenance and service/troubleshooting

- Visually inspect the frequency inverter when carrying out the required maintenance work and inspections at the machine/plant.
- Perform the maintenance work and inspections prescribed for the machine carefully, including the specifications on parts/equipment replacement.
- Work on the electrical components may only be performed by a qualified electrician according to the applicable rules of electrical engineering. Only use original spare parts.
- Unauthorized opening and improper interventions in the machine/plant can lead to personal injury or material damage. Repairs on the frequency inverters may only be carried out by the manufacturer or persons authorized by the manufacturer. Check protective equipment regularly.
- Before performing any maintenance work, the machine/plant must be disconnected from mains supply and secured against restarting. The five safety rules must be complied with.

2.10.8 Final decommissioning

Unless separate return or disposal agreements were made, recycle the disassembled frequency inverter components:

- Scrap metal materials
- Recycle plastic elements
- Sort and dispose of other component materials



Electric scrap, electronic components, lubricants and other utility materials must be treated as special waste and may only be disposed of by specialized companies.



In any case, comply with any applicable national disposal regulations as regards environmentally compatible disposal of the frequency inverter. For more details, contact the competent local authorities.





3 Device overview

This chapter describes the characteristic of the KFU series.

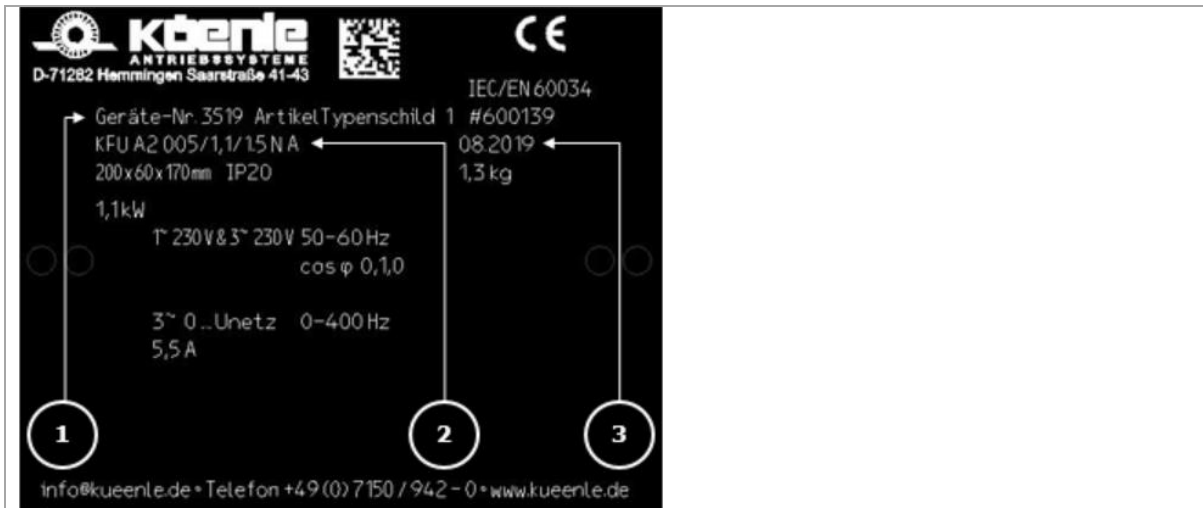
3.1 Inverter type and warning signs on the device

- Determine the type of frequency inverter.
- Verify that the rated input voltage corresponds to the local power supply.
- Verify that the recommended motor shaft power of the frequency inverter corresponds to the rated power of the motor.



1	Device Number
2	Type Description: KFU A2 005/1,1/1,5 N A (see the following selection.)
3	Date of production (beginn of warranty) Nominal voltage power input A2 → 230 V Nominal volatge power input A4 → 400 V
4	Warnings
	 Warning! Electrostaically sensitive components.
	 Warning! High leakage currents.
	 Warning! Dangerous voltage. The danger of the electric shock is on risk!
	 Warning! Hot surfaces.

3.2 Type designation

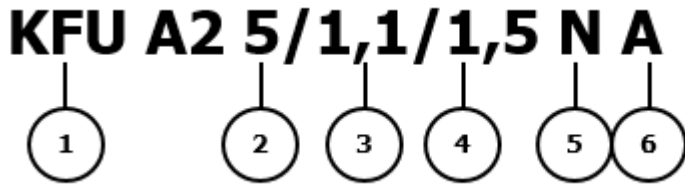

Basic Type designation	
1	Series: KFU A2: inverter KFU 1xAC 200 – 15 %...240 V + 10 % 3xAC 200 – 15 %...240 V + 10 % KFU A4: inverter KFU 3xAC 360...480 V +/- 10 %
2	Nominal current [A]
3	Nominal inverter power [kW]
4	Overload factor
5	EMC Filter F = integrated (default)
6	Design Version A = standard cooling (default) C = Cold Plate (optional)



The name plate shows the options at delivery.

Most of the options (with the exception of the Software Version) can be refitted by the user. Also the later modification (in example removing a CM module) is possible.



Devices with Functional Safety are marked accordingly. For information regarding the marking please comply with the application manual "Functional Safety".

3.3 Software Version Identification



The Software version plate is situated right from the memory card slot and left from the Control terminals.

3.4 Overview of components and connection terminals

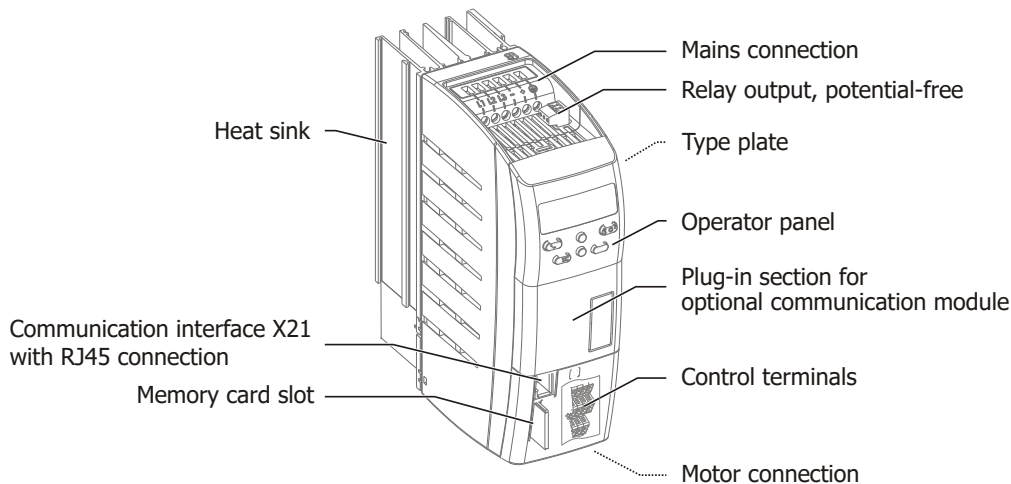

	See
Mains voltage connection	Chapter 5.5
The safety instructions must be complied with strictly.	Chapter 5.1
Motor Connection	Chapter 5.6
The safety instructions must be complied with strictly.	Chapter 5.1
Control terminals and relay output	Chapter 5.7
The safety instructions must be complied with strictly.	Chapter 5.1
CAN connection terminals	Separate instructions on System bus or CANopen® ¹ .
Operator panel	Chapter 0
Port for memory card (MMC)	Chapter 7.10.11 & Chapter 12.8
Communication interface X21 ²	Separate instructions on VABus or Modbus.
Port for one of the optional communication modules (see previous chapter for list)	Separate instructions on the protocols.

¹ The products for CANopen® communication comply with the specifications of the user organization CiA® (CAN in Automation).

² Install an interface adapter for connection of a PC. This enables configuration and monitoring using the PC software VPlus.

3.5 Number of control terminals

4 digital inputs	1 input for external voltage supply DC 24 V
2 digital inputs for enable	1 reference voltage output DC 10 V
1 digital input/output	1 voltage output DC 24 V
2 multifunction inputs: digital/analog input	1 relay output, potential-free
1 digital output	Control terminals for system bus or protocol CANopen®
1 multifunction output: digital/analog/frequency	

4 Mechanical Installation

The frequency inverters of degree of protection IP20 are designed, as a standard, for installation in electrical cabinets.

During installation, both the installation and the safety instructions as well as the device specifications must be complied with.

4.1 Safety



⚠ WARNING

To avoid serious physical injury or considerable damage to property, only qualified staff may work on the devices.



⚠ WARNING

During assembly, make sure that no foreign particles (e.g. chips, dust, wires, screws, tools) can get inside the frequency inverter. Otherwise there is the risk of short circuits and fire.

The frequency inverter complies with protection class IP20 only if the covers, components and terminals are mounted properly.

Overhead Installation or installation in horizontal position is not permissible.



⚠ CAUTION

Device damage

Due to mechanical stress on the heat sink, phase failure and device malfunctions can ensue.

- Avoid exerting mechanical stress on the heat sink.
- Handle the device with care.
- Avoid exerting mechanical tension on the device housing.

NOTICE

Mount the devices with sufficient clearance to other components so that the cooling air can circulate freely. Avoid soiling by grease and air pollution by dust, aggressive gases, etc.

Suction intakes of fans may not be covered.

4.2 Installation

Mounting distance

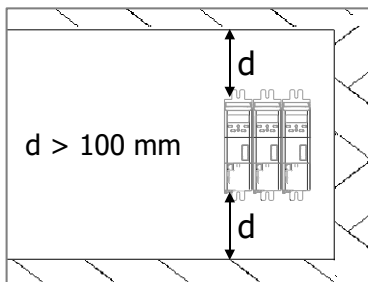

4.2.1 Size 1 (3~:0.18 kW to 2.2 kW; 1~: 0.09 kW to 1.1 kW)

Valid for the following devices

		Frequency Inverter		
Type		A2		A4
Connection		1ph.	3ph.	3ph.
Power		kW	kW	kW
Size 1	KFU	... 0,09 0,18 ...	---
	KFU	... 0,12 0,25 0,25 ...
	KFU	... 0,18 0,37 0,37 ...
	KFU	... 0,25 0,55 0,55 ...
	KFU	... 0,37 0,75 0,75 ...
	KFU	... 0,55 1,10 1,10 ...
	KFU	... 0,75 1,50 1,50 ...
	KFU	... 1,10 2,20 2,20 ...

Dimensions

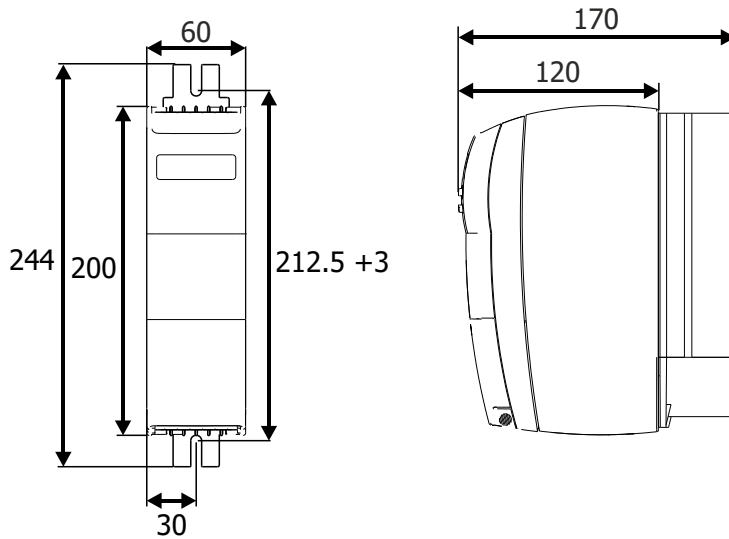

AGL_TZ_ASD_GR1_St_01_V01

Assembly

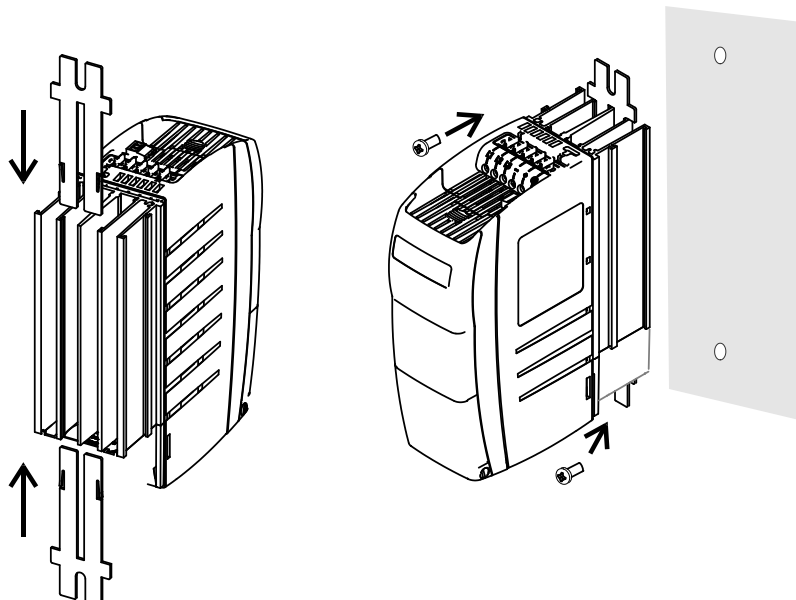

Use screws M6.

4.2.2 Size 2 (3~: 3.0 kW to 5.5 kW; 1~: 1.5 kW to 2.2 kW)

Valid for the following devices

Frequency Inverter				
Type	A2		A4	
Connection	1ph.	3ph.	3ph.	
Power	kW	kW	kW	
Size 2	KFU	... 1,5 3,0 3,0 ...
	KFU	... 2,2 4,0 4,0 ...
	KFU	--	--	... 5,5 ...
	KFU	--	--	... 7,5 ...

Dimensions

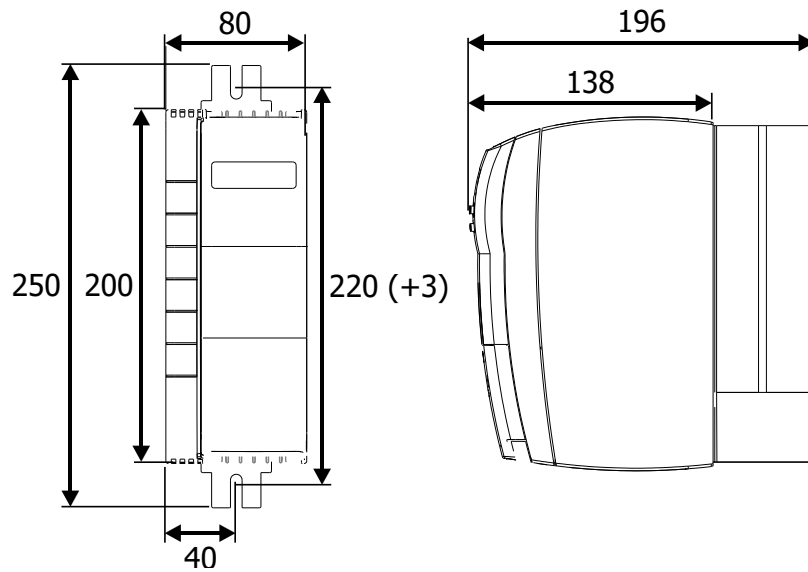

Assembly

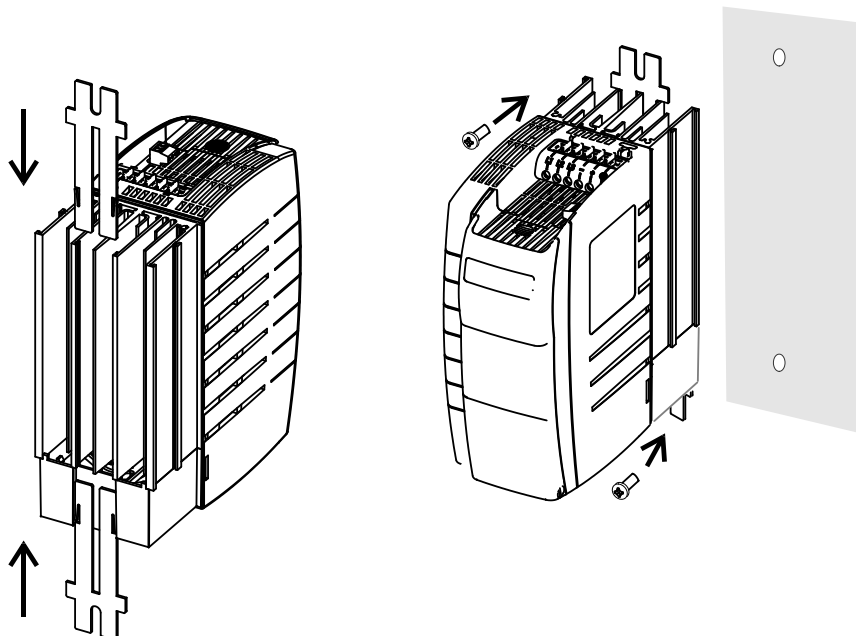

Use screws M6.

4.2.3 Size 3 (5.5 kW to 11.0 kW)

Valid for the following devices

		Frequency Inverter		
Type		A2		A4
Connection		1ph.	3ph.	3ph.
Power		kW	kW	kW
Size 3		... 3,0 5,5 5,5 ...
		... 3,0 7,5 7,5 ...
		--	--	... 9,2 ...
		--	--	... 11,0 ...

Dimensions

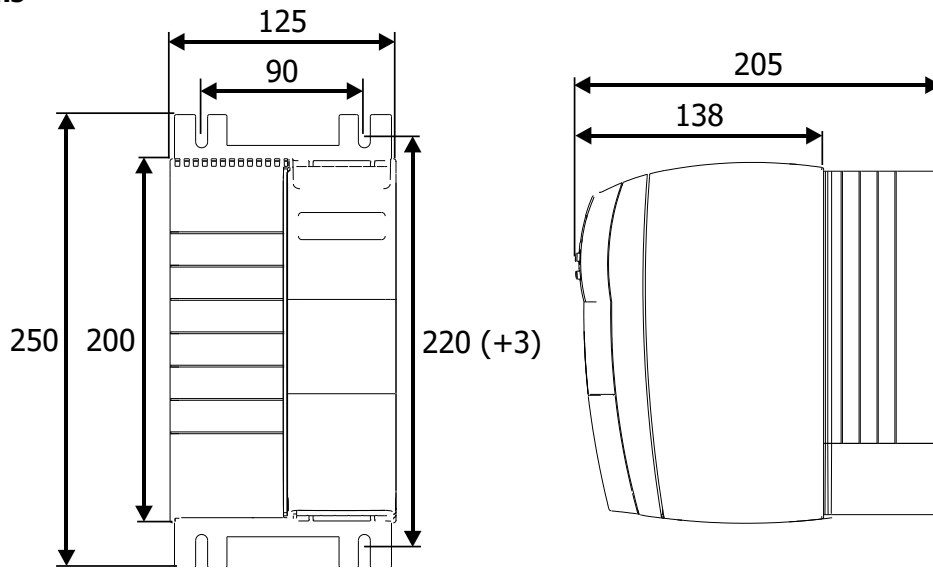

Assembly

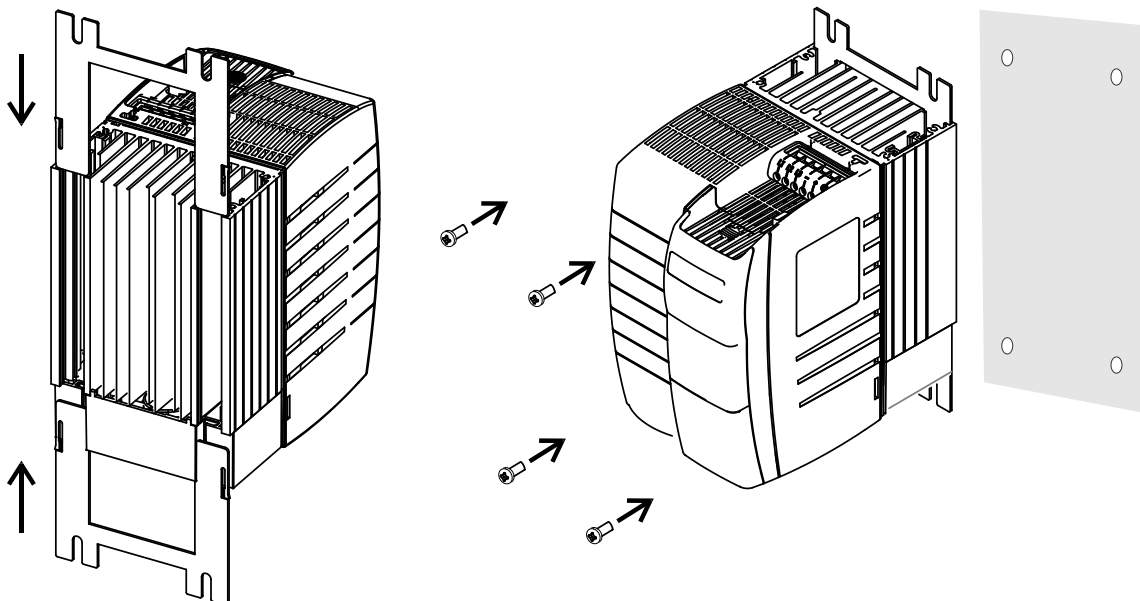

Use screws M6.

5 Electrical Installation

This chapter describes the electrical installation of the KFU series.

5.1 Safety



⚠ WARNING

The electrical installation must be carried out by qualified electricians according to the general and regional safety and installation directives.

The documentation and device specification must be complied with during installation.

Before any assembly or connection work, discharge the frequency inverter. Verify that the frequency inverter is discharged.

Do not touch the terminals because the capacitors may still be charged.

Only connect suitable voltage sources. The nominal voltage of the frequency inverter must correspond to the supply voltage.

The frequency inverter must be connected to ground potential.

If voltage supply is switched on, no covers of the frequency inverter may be removed.

The connecting cables must be protected externally, considering the maximum voltage and current values of the fuses. The mains fuses and cable cross-sections are to be selected according to EN 60204-1 and DIN VDE 0298 Part 4 for the nominal operating point of the frequency inverter. According to UL/CSA, the frequency inverter is suitable for operation at a supply network of a maximum of 480 VAC which delivers a maximum symmetrical current of 5000 A (effective value) if protected by fuses of class Bussmann FWP.

Only use copper cables with a temperature range of 60/75 °C.

In the case of special applications, you may also have to comply with further guidelines and instructions. The frequency inverters are to be grounded properly, i.e. large connection area and with good conductivity. The leakage current of the frequency inverters may be > 3.5 mA. According to EN 50178 a stationary installation must be provided. The protective conductor cross-section required for grounding the fixing plate must be selected according to the size of the unit. In these applications, the cross-section must correspond to the recommended cross-section of the wire. Refer to chapter 5.4 "Dimensioning of conductor cross-section".



⚠ CAUTION

Degree of protection IP20 is only achieved with terminals plugged and properly mounted covers.

CONNECTION CONDITIONS

- The frequency inverter is suited for connection to the public or industrial supply mains according to the technical data.
- It must be checked, based on the specifications of EN 61000-3-2, if the devices can be connected to the public supply means without taking additional measures. Increased requirements in connection with the specific application of the frequency inverter are to be met by means of optional components. Commutating chokes and EMC filters are optionally available.
- Operation on unearthed mains (IT mains) is admissible after pulling out the IT mains plug-in jumper.

Interference-free operation with residual current device is guaranteed at a tripping current ≥ 30 mA if the following points are observed:

- All-current sensitive residual current devices (Type B to EN 50178)
- Use EMC filters with reduced leakage current or, if possible, do not use EMC filters at all.
- The length of the shielded motor cable is ≤ 10 m and there are no additional capacitive components between the mains or motor cables and PE.

For connection to IT mains, refer to chapter 5.4.1.

5.2 Electrical connections overview

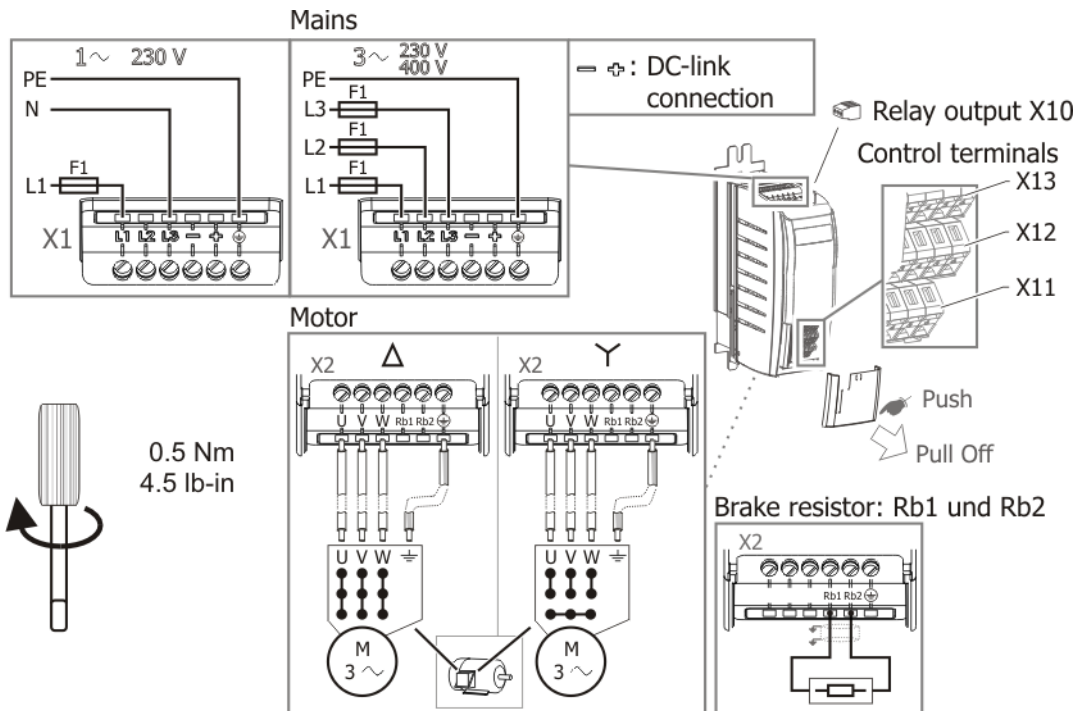

For connection refer to the corresponding chapter.

5.3 EMC Information

The frequency inverters are designed according to the requirements and limit values of product norm EN 61800-3 with an interference immunity factor (EMI) for operation in industrial applications. Electro-magnetic interference is to be avoided by expert installation and observation of the specific product information.

MEASURES

- Install the frequency inverters on a metal mounting panel that is connected to the equipotential bonding. Ideally, the mounting panel should be galvanized, not painted.
- Provide proper equipotential bonding within the plant. Plant components such as control cabinets, control panels, machine frames must be connected to the equipotential bonding by means of low inductive wire mesh.
- Connect the shields of the cables on both sides to the mounting panel that is not painted and connected to the equipotential bonding.
- Connect the shield of analog control cables to the equipotential bonding only on one side near to the frequency inverter.
- Connect the frequency inverter and other components, e.g. external filters and other components to the equipotential bonding via short cables.
- Keep the cables as short as possible; make sure that cables are installed properly using appropriate cable clamps, etc.
- Contactors, relays and solenoids in the electrical cabinet are to be provided with suitable interference suppression components.

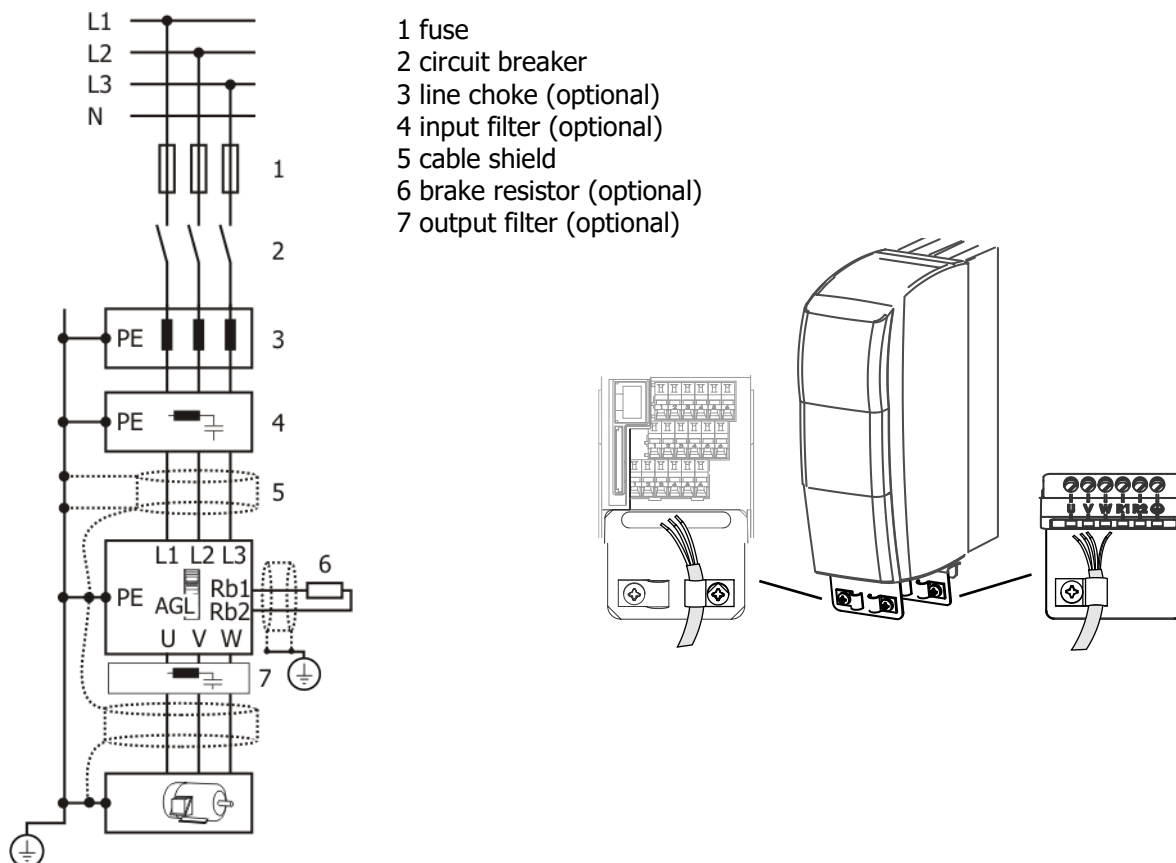

- 1 fuse
- 2 circuit breaker
- 3 line choke (optional)
- 4 input filter (optional)
- 5 cable shield
- 6 brake resistor (optional)
- 7 output filter (optional)

Optional shield sheets can be used for the cable shielding. Refer to chapter 12.2 "Shield sheets".

Mains Connection

Install the mains supply cable separate from the control and data cables and the motor cable.

DC link connection

The frequency inverter may be connected via the terminals "-" and "+" of terminal block X1 to further *KFU*- or *ACTIVE*-devices or to a common direct voltage source. Cables longer than 300 mm are to be shielded. The shield must be connected across a wide area contact on both sides to the unpainted conductive mounting panel.

Control connection

Control and signal cables must be kept physically separate from the power cables.

Analog signal lines must be shielded. The shield is to be connected to the unpainted conductive mounting panel that is connected to equipotential bonding. An optional shield sheet can be used for shielding. Refer to chapter 12.2.1 "Shield sheet for control cables".

Motor and brake resistor

Connect the shield of the motor cable to the unpainted conductive mounting panel that is connected to equipotential bonding.

An optional shield sheet can be used for shielding. Refer to chapter 12.2.2 "Shield sheet for motor cables".

The signal cable used for monitoring the motor temperature must be kept separate from the motor cable. Connect the shield of this line on both sides.

If a brake resistor is used, the connection cable must be shielded. Connect the shield in consideration of EMC.

Line choke

Line chokes reduce mains harmonics and reactive power. Additionally, the increase of product life is possible. Consider the reduction of the maximum output voltage if a line choke is installed.

The line choke must be installed between mains connection and input filter.

KÜENLE provides applicable line chokes. Refer to chapter 12.4 "Line choke".

Input filter

Input filters reduce the conducted radio-frequency interference voltage. The input filter must be installed upstream on mains side of the frequency inverter.



⚠ CAUTION

The frequency inverters meet the requirements of the low-voltage directive 2006/95/EC and the requirements of the EMC directive 2004/108/EC. The EMC product standard EN 61800-3 relates to the drive system. The documentation provides information on how the applicable standards can be complied if the frequency inverter is a component of the drive system. The declaration of conformity is to be issued by the supplier of the drive system.

5.4 Dimensioning of conductor cross-section

- The cable dimensions must be selected according to the current load and voltage drop to be expected.
- Select the cable cross-section of the cables such that the voltage drop is as small as possible. If the voltage drop is too great, the motor will not reach its full torque.
 - Comply with any additional national and application-specific regulations and the separate UL instructions. For typical mains fuses, refer to chapter 11 "Technical data".

Select cross-sections of PE conductor according to EN61800-5-1:

Mains cable	Protective conductor
Mains cable up to 10 mm ²	Install two protective conductors of the same size as the mains cable, or one protective conductor of a size of 10 mm ² .
Mains cable 10...16 mm ²	Install one protective conductor of the same size as the mains cable.
Mains cable 16...35 mm ²	Install one protective conductor with a cross-section of 16 mm ² .
Mains cable > 35 mm ²	Install one protective conductor of half the size of the mains cable.

5.4.1 Typical cross-sections

The following table provides an overview of typical cable cross-sections (copper cable with PVC insulation, 30 °C ambient temperature, continuous mains current max. 100% rated input current). Actual cable cross-section requirements may deviate from these values due to actual operating conditions.

Single-phase connection (L1/N), 230 V

Type	Power Cable	PE-Line	Motor Cable
KFU ... 0,09 ...	1,5 mm ²	2x1,5 mm ² oder 1x10 mm ² ¹⁾	1,5 mm ²
KFU ... 0,12 ...			
KFU ... 0,18 ...			
KFU ... 0,25 ...			
KFU ... 0,37 ...			
KFU ... 0,55 ...			
KFU ... 0,75 ...			
KFU ... 1,10 ...			
KFU ... 1,50 ...			
KFU ... 2,20 ...	2,5 mm ²	2x2,5 mm ² oder 1x10 mm ² ¹⁾	1,5 mm ²
KFU ... 3,00 ...	4 mm ²	2x4 mm ² oder 1x10 mm ² ¹⁾	1,5 mm ²
KFU ... 3,00 ...			

¹⁾ Connection on protective earth on mounting plate.

KFU A2- / A4-

Three-phase connection (L1/L2/L3), 230 V

Type		Power Cable	PE-Line	Motor Cable
KFU	... 0,18 ...	1,5 mm ²	2x1,5 mm ² oder 1x10 mm ² ¹⁾	1,5 mm ²
KFU	... 0,25 ...			
KFU	... 0,37 ...			
KFU	... 0,55 ...			
KFU	... 0,75 ...			
KFU	... 1,10 ...			
KFU	... 1,50 ...			
KFU	... 2,20 ...			
KFU	... 3,00 ...			
KFU	... 4,00 ...	2,5 mm ²	2x2,5 mm ² oder 1x10 mm ² ¹⁾	1,5 mm ²
KFU	... 5,50 ...	4 mm ²	2x4 mm ² oder 1x10 mm ² ¹⁾	4 mm ²
KFU	... 7,50 ...	6 mm ²	2x6 mm ² oder 1x10 mm ² ¹⁾	4 mm ²

¹⁾ Connection on protective earth on mounting plate.

Three-phase connection (L1/L2/L3), 400 V

Type		Power Cable	PE-Line	Motor Cable
KFU	... 0,25 ...	1,5 mm ²	2x1,5 mm ² oder 1x10 mm ² ¹⁾	1,5 mm ²
KFU	... 0,37 ...			
KFU	... 0,55 ...			
KFU	... 0,75 ...			
KFU	... 1,10 ...			
KFU	... 1,50 ...			
KFU	... 2,20 ...			
KFU	... 3,00 ...			
KFU	... 4,00 ...			
KFU	... 5,50 ...	2,5 mm ²	2x2,5 mm ² oder 1x10 mm ² ¹⁾	2,5 mm ²
KFU	... 7,50 ...			
KFU	... 9,20 ...			
KFU	... 11,0 ...	4 mm ²	2x4 mm ² oder 1x10 mm ² ¹⁾	4 mm ²

¹⁾ Connection on protective earth on mounting plate.

Please note, that the mentioned typical cross sections do not consider other factors like fuses. Comply with applying local standards and applying branch standards.

5.5 Mains Connection

⚠ DANGER



Disconnect the frequency inverter from mains voltage and protect it against being energized unintentionally.

Verify that the frequency inverter is discharged.

Wait for some minutes until the DC link capacitors have discharged before starting to work at the unit.

When the frequency inverter is disconnected from power supply, the mains, DC-link voltage and motor terminals may still be live for some time.

The mains fuses and cable cross-sections are to be selected according to EN 60204-1 and DIN VDE 0298 Part 4 for the nominal operating point of the frequency inverter. According to UL/CSA, approved Class 1 copper lines with a temperature range of 60/75°C and matching mains fuses are to be used for the power cables. The electrical installation is to be done according to the device specifications and the applicable standards and directives.

⚠ CAUTION



The control, mains and motor lines must be kept physically separate from one another.

The cables connected to the frequency inverters may not be subjected to high-voltage insulation tests unless appropriate circuitry measures are taken before.

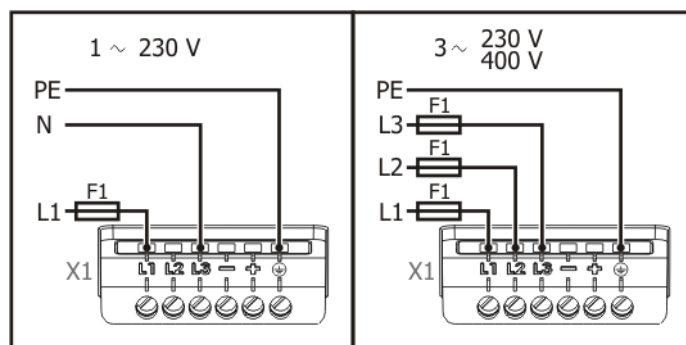

Minimum Torque to tighten the screws: **0.5 Nm** (4.6 lb-in)

Maximum Torque to tighten the screws: **0.6 Nm** (5.3 lb-in)

Recommended sizes of Mains fuses F1 are described in the technical data chapter 11.2 "Device data".

⇒ ⚡: Only for in DC link connections.

Comply with the notes on cable cross-sections in chapter 5.4 "Dimensioning of conductor cross-section".

	Cable cross-sections mm ²
Mains terminals:	0.2 ... 4 (flexible cable with sleeve)
	0.2 ... 6 (rigid cable)

Connection to IT mains

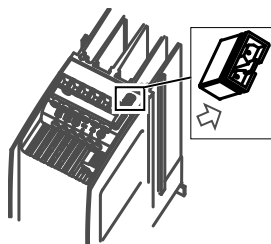

For connection to IT mains, pull out the plug-type jumper.

NOTICE

Removing the jumper reduces interference immunity and increases the emitted interference. Interference immunity can be increased by means of external filters.

Additional work for EMC conformity may be possible. Comply with the EMC information.

5.6 Motor Connection

DANGER

Disconnect the frequency inverter from mains voltage and protect it against being energized unintentionally.

Verify that the frequency inverter is discharged.

Wait for some minutes until the DC link capacitors have discharged before starting to work at the unit.

When the frequency inverter is disconnected from power supply, the mains, DC-link voltage and motor terminals may still be live for some time.

When using pluggable terminals: Do not switch on the device while the plugs are disconnected, the IP protection is only warranted with plugged terminals.



KÜENLE recommends connecting the motor to the frequency inverter using shielded cables.

- Connect the cable shield to PE potential properly, i.e. with good conductivity, on both sides.
- The motor cables must be kept physically separate from the control and network cables.

The user must comply with the applicable limits stipulated in the relevant national and international directives as regards the application, the length of the motor cable and the switching frequency.

Connect in delta connection or star connection according to the motor data.

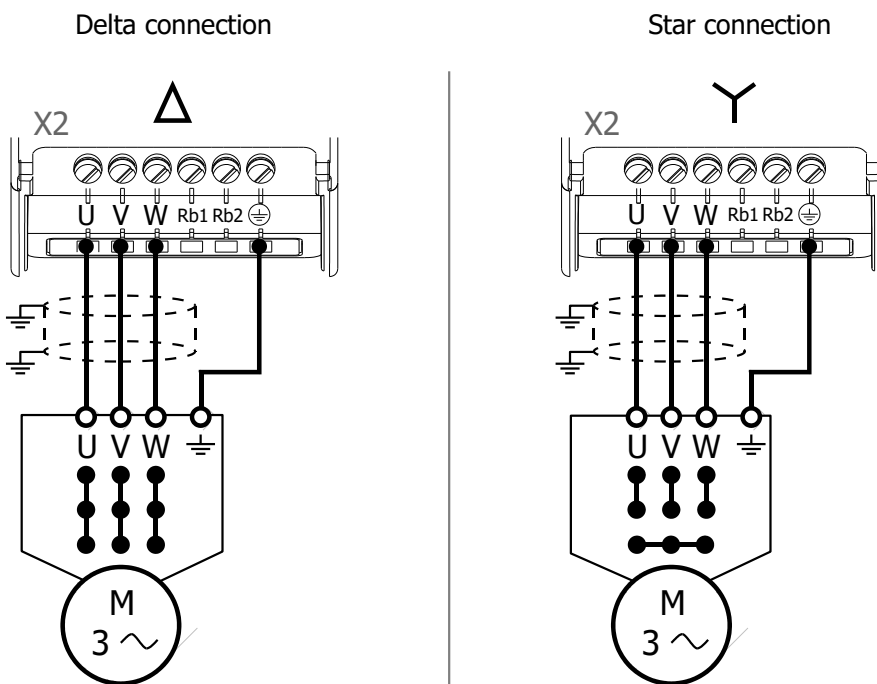

Minimum Torque to tighten the screws: **0.5 Nm** (4.6 lb-in)

Maximum Torque to tighten the screws: **0.6 Nm** (5.3 lb-in)

Comply with the notes on cable cross-sections in chapter 5.4 "Dimensioning of conductor cross-section".

	Cable cross-sections mm ²
Motor terminals:	0.2 ... 4 (flexible cable with sleeve)
	0.2 ... 6 (rigid cable)

5.6.1 Length of motor cables, without filter

Motor Cable without output filter						
Type	A2		A4	Unshielded cable	Shielded cable	
Power Cable	1ph.	3ph.	3ph.			
Power	kW	kW	kW			
Size 1	KFU	... 0,09 0,18 ...	--	50 m	25 m
	KFU	... 0,12 0,25 0,25 ...		
	KFU	... 0,18 0,37 0,37 ...		
	KFU	... 0,25 0,55 0,55 ...		
	KFU	... 0,37 0,75 0,75 ...		
	KFU	... 0,55 1,10 1,10 ...		
	KFU	... 0,75 1,50 1,50 ...		
	KFU	... 1,10 2,20 2,20 ...		
Size 2	KFU	... 1,50 3,00 3,00 ...	100 m	50 m
	KFU	... 2,20 4,00 4,00 ...		
	KFU	--	--	... 5,50 ...		
	KFU	--	--	... 7,50 ...		
Size 3	KFU	... 3,00 5,50 5,50 ...	100 m	50 m
	KFU	... 3,00 7,50 7,50 ...		
	KFU	--	--	... 9,20 ...		
	KFU	--	--	... 11,0 ...		

The specified lengths of the motor cables must not be exceeded if no output filter is installed.

5.6.2 Motor cable length, with output filter du/dt

Longer motor cables can be used after taking appropriate measures, e.g. use of low-capacitance cables and output filters. The following table contains recommended values for the use of output filters.

5.6.3 Motor cable length, with sinus filter

Motor cables can be longer if sinus filters are used. By conversion in sinus-shaped currents, high-frequency portions which might limit the cable length are filtered out. Consider the voltage drop across the cable length and the resulting voltage drop at the sinus filter. The voltage drop results in an increase of the output current. The frequency inverter must be suitable for the higher output current. This must be considered in the projecting phase.

In the case of motor cable lengths exceeding 300 m, contact KÜENLE service.

5.6.4 Group drive

In the case of a group drive (several motors at one frequency inverter), the total length must be divided across the individual motors according to the value given in the table. See chapter 5.6.1.

Use a thermal monitoring element on each motor (e.g. PTC resistor) in order to avoid damage.

A group drive with synchronous server motors is not possible.

5.6.5 Brake resistor

Installing a brake resistor if feedback of generator energy is expected. Overvoltage shutdowns can be avoided by this.

DANGER



Disconnect the frequency inverter from mains voltage and protect it against being energized unintentionally.

Verify that the frequency inverter is discharged.

Wait for some minutes until the DC link capacitors have discharged before starting to work at the unit.

When the frequency inverter is disconnected from power supply, the mains, DC-link voltage and motor terminals may still be live for some time.

WARNING



During operation, the surface of the brake resistor can reach high temperatures. The surface can keep high temperatures after operation for a certain time. Do not touch the brake resistor during operation or operational readiness of the frequency inverter. Non-compliance may result in skin burn.

Install a safeguard for protection against contact or fix warning labels.

Do not install the brake resistor in the proximity to flammable or heat-sensitive materials. Do not cover the brake resistor.

CAUTION



KÜENLE ANTRIEBSSYSTEME recommends using a temperature switch. Depending on the selected resistor the temperature switch is integrated as a standard or optional available. A detailed list is included in Chapter 12.3 "Brake resistor". The temperature switch disconnects the frequency inverter from mains supply if the brake resistor is overloaded.

Using Brake resistors without temperature switches can result in critical states.

Minimize cable lengths.

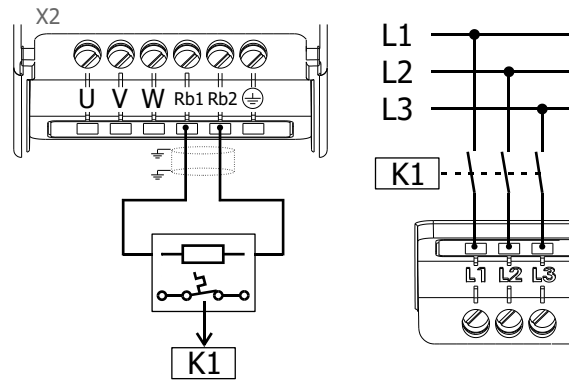

Minimum Torque to tighten the screws: **0.5 Nm** (4.6 lb-in)
Maximum Torque to tighten the screws: **0.6 Nm** (5.3 lb-in)

NOTICE

KÜENLE provides suitable brake resistors. Refer to chapter 12.3 "Brake resistor".
For calculation of brake resistance refer to chapter 7.10.4.1 "Dimensioning of brake resistor".

NOTICE

DC-connection requires a power estimation of the complete system. The brake resistor is operational dependent on the enable of the frequency inverter. The contactor K1 must disconnect all plant components from the mains.

5.7 Control terminals Standard connection

⚠ CAUTION



The unit may only be connected with the power supply switched off.

Verify that the frequency inverter is discharged.

Switch off power supply before connecting or disconnecting the control inputs and outputs. Verify that the keyed control inputs and outputs are deenergized before connecting or disconnecting them. Otherwise, components may be damaged.

Factory settings

External power supply (optional)

$I_{max} = 1 A$

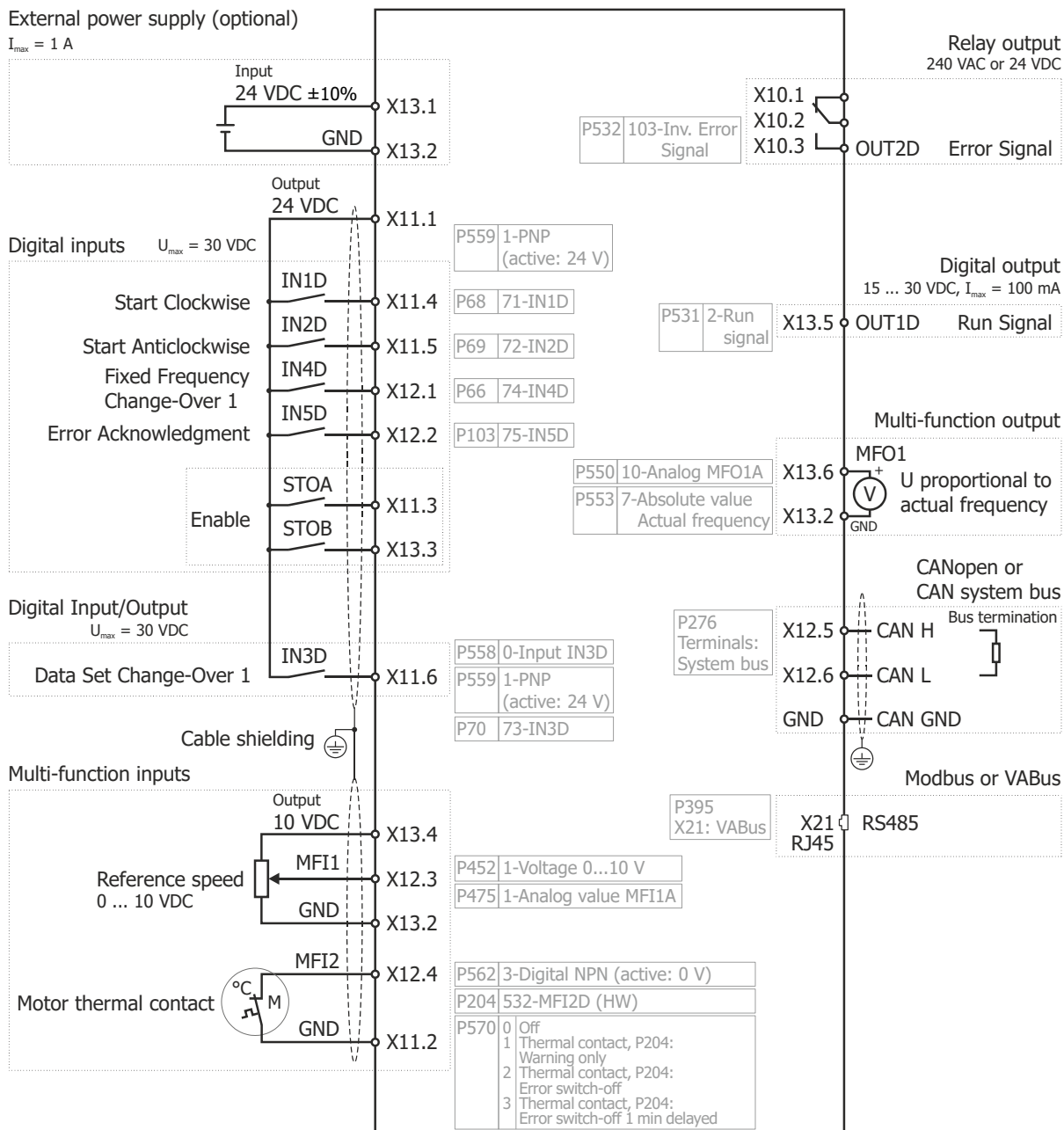

Comply with the technical data of control terminals: See chapter 11.3 "Control electronics".

For evaluation of the motor thermo contact, parameter *Operation Mode Motor-PTC* **570** must be set. See Chapter 7.4.6 "Motor temperature".

Via parameters *Digital inputs PNP/NPN* **559**, the logic evaluation at IN1D, IN2D, IN4D and IN5D is changed.

KFU A2- / A4-

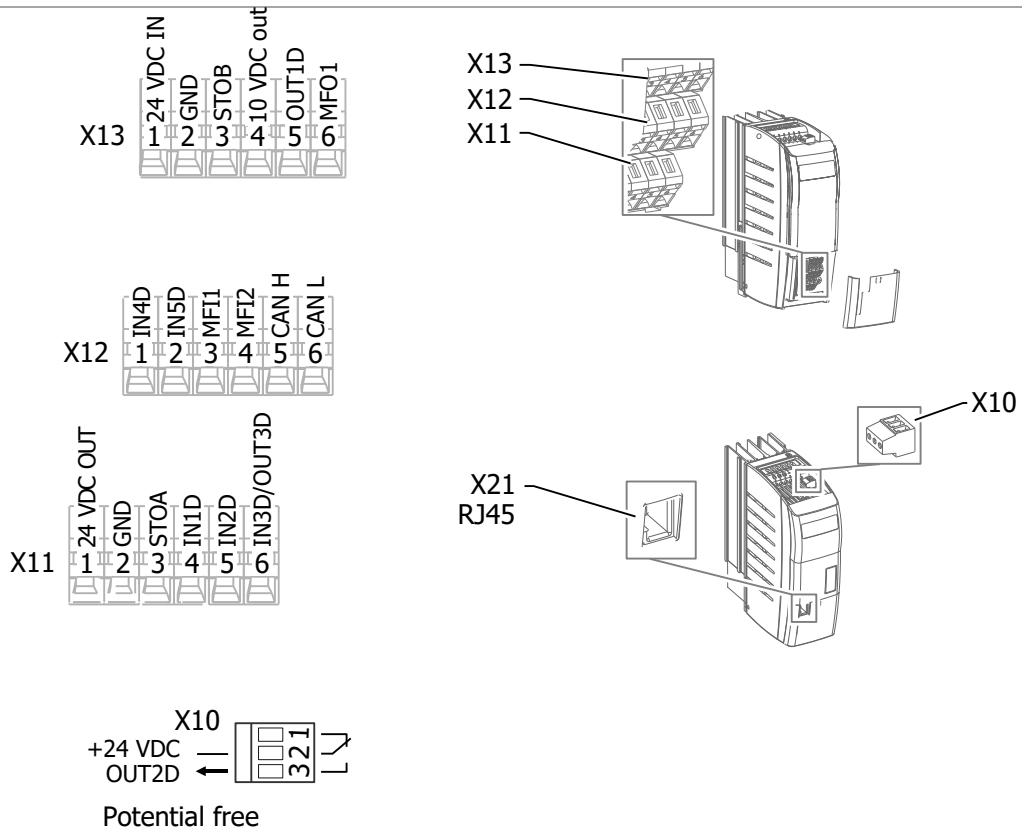

Digital inputs:

Terminal	Signal for functions	Function
X11.4	IN1D 71 IN1D	<i>Start Clockwise</i> 68
X11.5	IN2D 72 IN2D	<i>Start Anticlockwise</i> 69
X12.1	IN4D 74 IN4D	<i>Fixed Frequency Change-Over 1</i> 66
X12.2	IN5D 75 IN5D	<i>Error Acknowledgment</i> 103
X11.3	STOA 70 Enable (fixed assignment)	Enable
X13.3	STOB 70 Enable (fixed assignment)	

Changeover of evaluation at digital inputs:

Terminal	Operation modes
X11.4	<i>Digital inputs PNP/NPN</i> 559 0 NPN (active: 0 V) 1 PNP (active: 24 V)
X11.5	
X12.1	
X12.2	

Multifunction inputs (analog input/digital input):

Terminal	Operation modes	Function
X12.3	Analog: MFI1A 1 voltage 0...10 V Digital: MFI1D 2 current 0...20 mA 3 digital NPN (active: 0V)	<i>Operation Mode MFI1</i> 452 1 voltage 0 ... 10V <i>Reference Frequency Source 1</i> 475 , <i>Reference Percentage Source 1</i> 476
	Analog: MFI2A 4 digital PNP (active: 24V) 5 current 4...20 mA Digital: MFI2D 6 voltage, characteristic 7 current, characteristic	<i>Operation Mode MFI2</i> 562 3 digital PNP (active: 0V) <i>Thermo contact for P570</i> 204 , <i>Set Operation Mode Motor Temp.</i> 570 to 1, 2 or 3

Digital output:

Terminal	Function
X13.5	OUT1D <i>Operation mode OUT1D (X13.5)</i> 531 2 Run Signal

Multifunction output (analog output/digital output):

Terminal	Operation modes	Function
X13.6	MFO1D 1 Digital MFO1D <i>Operation Mode MFO1 (X13.6)</i> 550	<i>Digital: Source MFO1D</i> 554 4 Setting Frequency <i>Analog: Source MFO1A</i> 553 7 Abs. value of actual frequency
	MFO1A 10 Analog (PWM) MFO1A	
	MFO1F 20 Repetition frequency (RF) MFO1F	<i>RF/PT: Output Value MFO1F</i> 555 1 Actual Frequency
	MFO1F 30 Pulse Train (PT) MFO1F	<i>PT: Scaling Frequency</i> 557

Relay output:

Terminal	Function
X10	OUT2D <i>Operation Mode OUT2D (X10/Relay)</i> 532 103 Inv. error signal

Digital input/output:

Terminal	Operation modes	Function
X11.6	IN3D <i>Operation Mode Terminal X11.6</i> 558 0 Input IN3D <i>Digital inputs PNP/NPN</i> 559	0 NPN (active: 0 V) 1 PNP (active: 24 V) <i>Data Set Change-Over 1</i> 70
	OUT3D 1 Output OUT3D <i>Op.Mode OUT3D (X11.6)</i> 533	103 Inv. error signal

IN: input, OUT: output, MFI: Multi-function input MFO: Multi-function output,

D: digital, A: analog, F: frequency, PT: pulse train, RF: Repetition frequency, Op. Mode: Operation Mode

5.7.1 Circuit for control via control terminals

The motor is started via start signals on the control terminals. The circuit shows the input signals required as a minimum and the control terminals in factory settings.

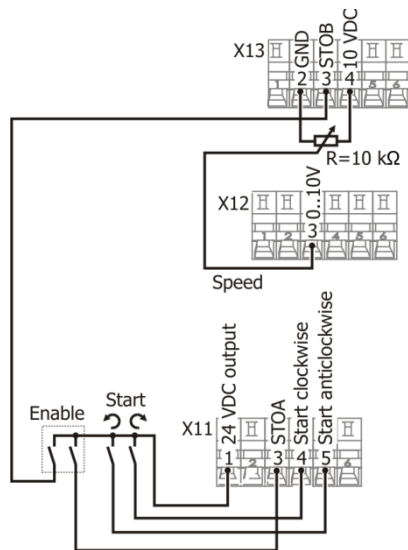



∅  1.5 mm²
max. 2.5 mm²

- Start cw: Start clockwise operation
- Start ccw: Start anticlockwise operation
- VDC out: Voltage output
- n: Speed
- E: Enable

5.7.2 Circuit for control via operator panel

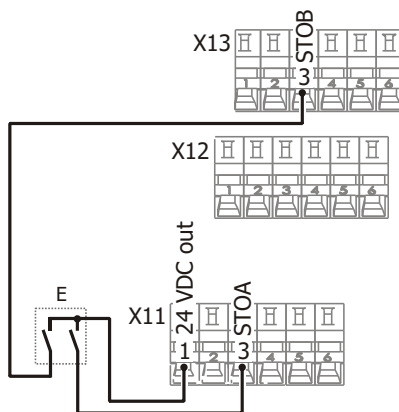
The motor is started via the operator panel. The circuit shows the input signals required as a minimum and the control terminals in factory settings.



∅  1.5 mm²
max. 2.5 mm²

- VDC out: Voltage output
- E: Enable

5.7.3 Further setting options for control terminals

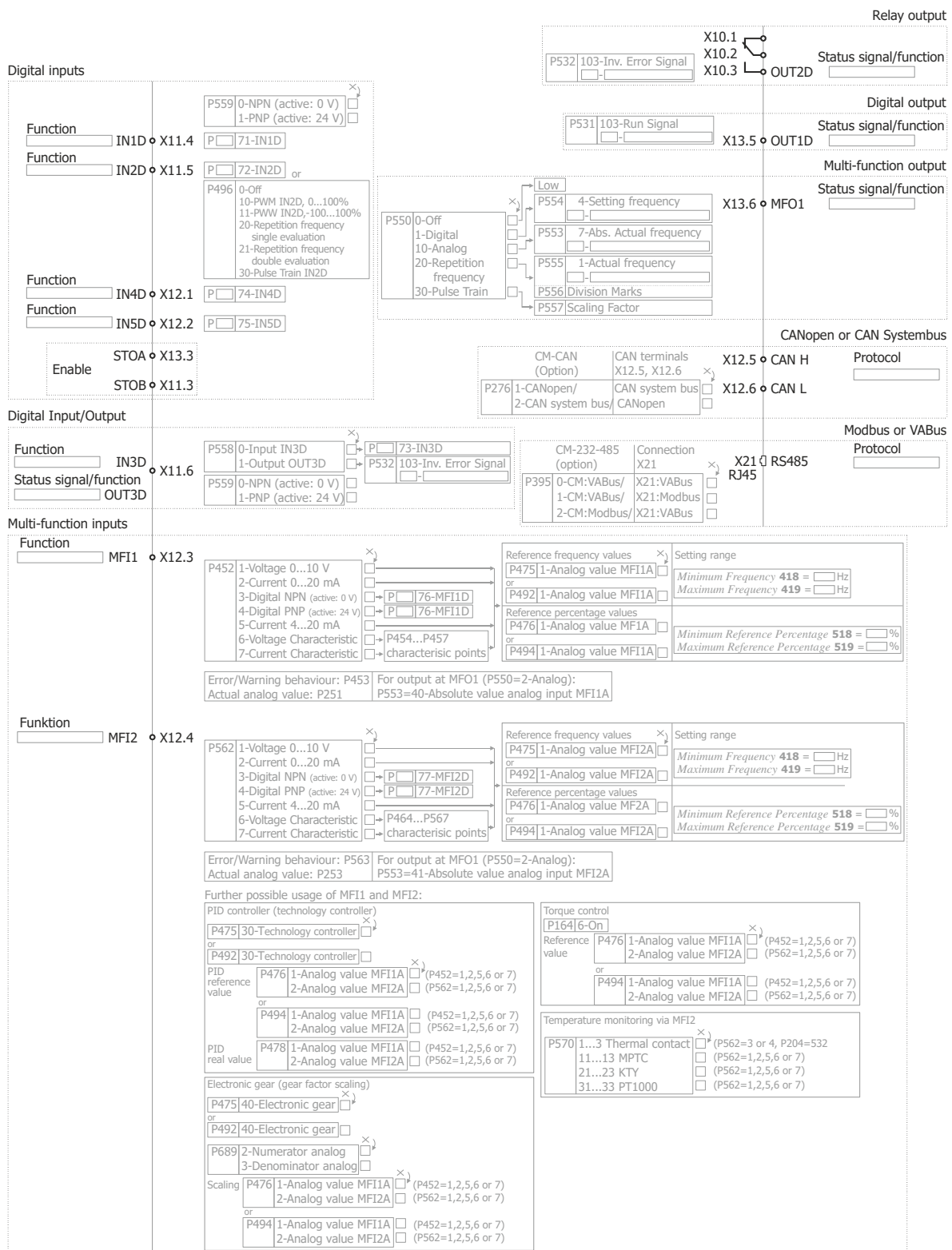

AGL_TD_AnschDiagr_Steuerkl_Aendrng_Werkseinst_01_V01

The block diagram only shows a selection of possible uses of the inputs and outputs.

5.7.4 Evaluation logic of digital inputs

The evaluation logic of the digital inputs and multifunction inputs - in digital operation mode - can be changed over via parameter settings.

- Select "0 - NPN (active: 0 V)" or "1 - PNP (active: 24 V)" for parameter *Digital inputs PNP/NPN 559*.

Digital inputs

Terminal	Input	<i>Digital inputs PNP/NPN 559</i>	
X11.4	IN1D	0 - NPN (active: 0 V)	Low-switching (with negative signal).
X11.5	IN2D	1 - PNP (active: 24 V)	High-switching (with positive signal). Factory setting.
X11.6	IN3D		
X12.1	IN4D		
X12.2	IN5D		

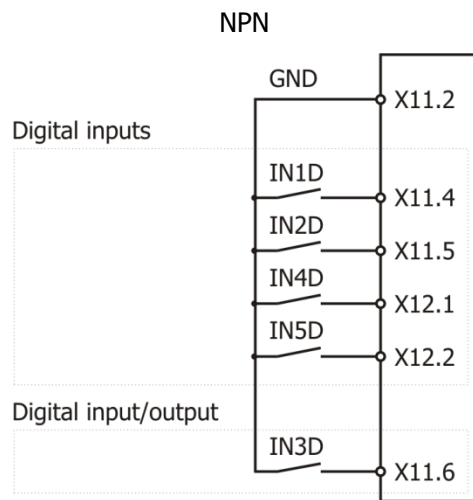
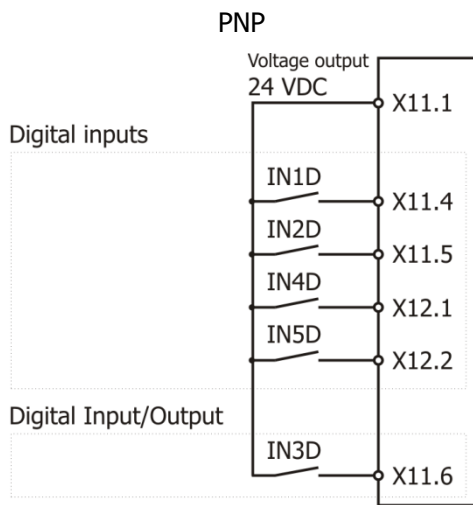

Multifunction inputs

Terminal	Input	<i>Operation Mode MF11 452</i>	
X12.3	MFI1	3 digital NPN (active: 0 V)	Low-switching (with negative signal).
		4 digital PNP (active: 24 V)	High-switching (with positive signal).

Terminal	Input	<i>Operation Mode MF12 562</i>	
X12.4	MFI2	3 digital NPN (active: 0 V)	Low-switching (with negative signal). Factory setting.
		4 digital PNP (active: 24 V)	High-switching (with positive signal).

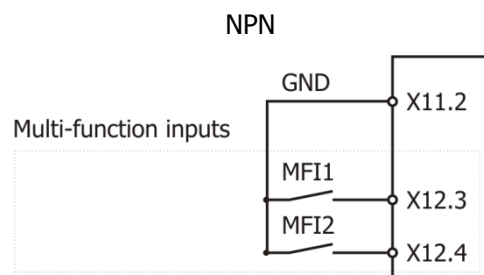
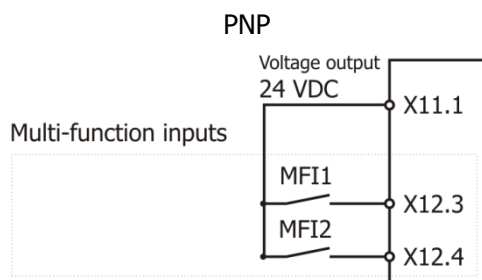

5.7.5 Overview of voltage inputs and outputs

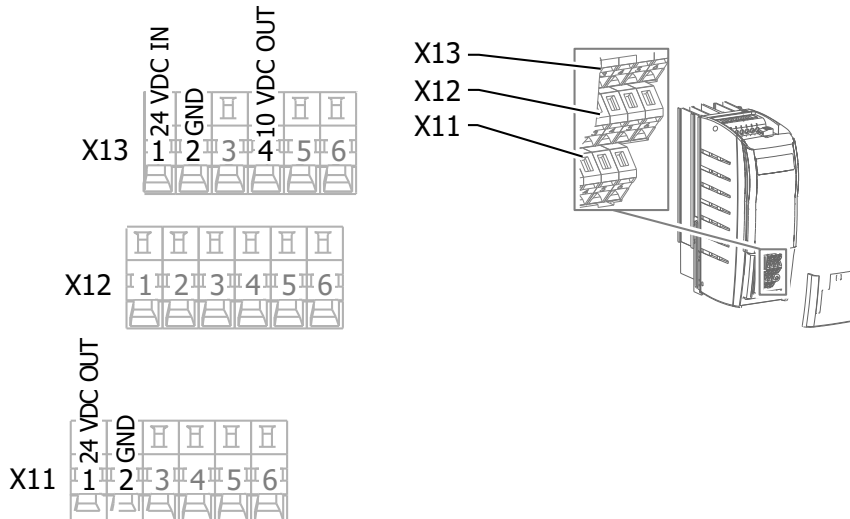

5.7.6 External DC 24 V power supply

An external power supply DC 24 V can be connected to control terminals X13.1/X13.2. The external power supply enables parameter configuration, maintenance of input/output functions and communication, even while the mains voltage is switched off.

Requirements to be met by external power supply	
Input voltage range	DC 24 V \pm 10%
Rated input current	Max. 1.0 A (typically 0.45 A)
Peak inrush current	Typically: < 15 A (max. 100 μ s)
External fuse	Via standard fuse elements for rated current, characteristic: slow
Safety	Safety extra low voltage (SELV) according to EN 61800-5-1

CAUTION



Device damage

The digital inputs and the DC 24 V terminal of the electronic control equipment can withstand external voltage up to DC 30 V. Higher voltages may destroy the unit.

- Use suitable external power supply units with a maximum output voltage of DC 30 V or use appropriate fuses to protect the unit.

Operation of the frequency inverter is not affected if the mains voltage is switched on and the external power supply is switched off.

NOTE:

The application manual "Safe Torque Off STO" must be complied with if the safety function described there is used.

Exceptions:

Mains voltage must be switched on for the following functions. The function is not enabled if only an external power supply is applied.

- The relay output X10 is controlled only if mains voltage is switched on.
- The heat sink fan and the internal fan are controlled only if mains voltage is switched on.

5.7.7 Installation notes according to UL508c

NOTICE

No branch circuit protection

Integral solid state short circuit protection does not provide branch circuit protection.

- Branch circuit protection must be provided in accordance with the Manufacturer Instructions, National Electrical Code and any additional local codes.

For an installation according to UL508c the motor must be supervised regarding the thermal behaviour. The connection and the parameter settings for the temperature motor supervision is described in chapter 5.7 "Control terminals Standard connection".

For an installation according to UL508c only allowed fuses can be used for mains protection. The allowed fuses are described in chapter 11.2 "Device data".

For an installation according to UL508c the in chapter 11.2 "Device data" described maximum temperatures must not be exceeded.

For an installation according to UL508c only 60/75°C copper conductors are allowed to be used.

For an installation according to UL508c the devices are only allowed to be used in environments according to Pollution Degree 2.

According to UL508c Warning or Marking labels are not allowed to be removed.

Short-circuit current rating

Suitable For Use On A Circuit Capable Of Delivering Not More Than 5000 rms Symmetrical Amperes, 480 Volts Maximum (models 402), 240 Volts Maximum (models 202) When Protected by Fuses manufactured by Bussmann, model FWP-10A14Fa (Size 1), FWP-20A14Fa (Size 2) or FWP-30A14Fa (Size 3). Drive controller and overcurrent protection device must be integrated within the same overall assembly.

6 Commissioning

The unit may also be commissioned as described in the Quick Start Guide. This guide is supplied with the device.

In this chapter, first commissioning and commissioning for typical applications are described.



⚠ WARNING

The frequency inverter may only be commissioned by qualified staff.
 Prior to commissioning, all covers must be fixed, all standard equipment components of the frequency inverter must be installed, and the terminals must be checked.

Procedure:

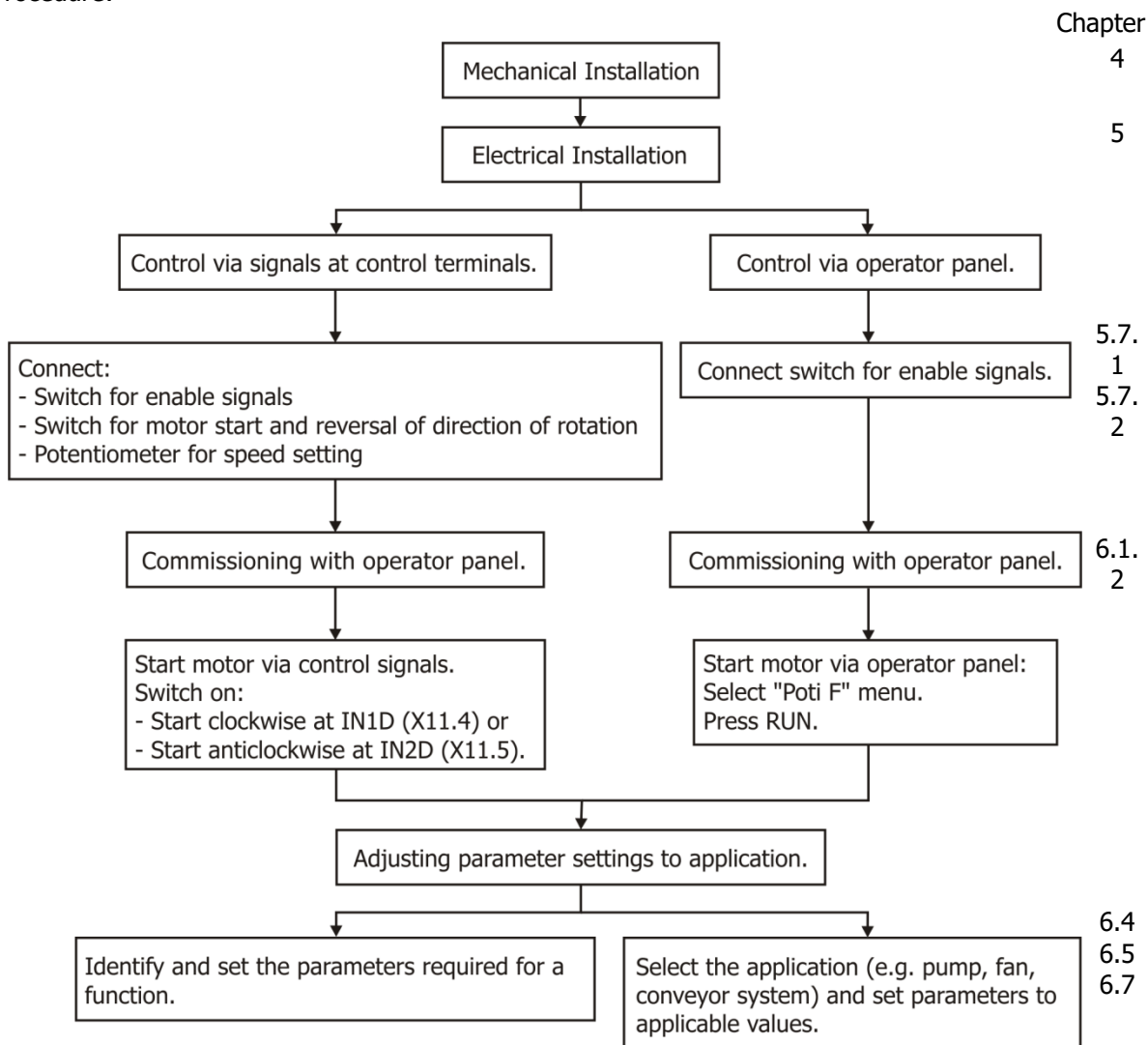

6.1 Operator panel

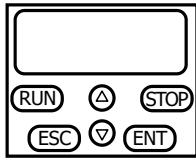

<p>(RUN) Start motor.</p> <p>(STOP) Stop motor. If fault is present: Fault reset</p> <p>(ESC) Cancel. Back to previous menu.</p> <p>(ENT) Confirm settings.</p> <p>(RUN) Reverse direction of rotation in motor potentiometer function.</p> <p>+ (ENT) Reduce speed in motor potentiometer function.</p>	<p>⬆ Increase speed in motor potentiometer function. Switch to the higher parameter number. Increase parameter values.</p> <p>⬇ Reduce speed in motor potentiometer function. Switch to the lower parameter number. Reduce parameter values.</p>
----------------------------------------------------------------------------------------------------------------------------------------------------------------------------------------------------------------------------------------------------------------------------------------------------------------------	------------------------------------------------------------------------------------------------------------------------------------------------------------------------------------------------------------------------------------------------------------------

Press arrow key for a short time to set a value in discrete steps.

Keep arrow key pressed for a quick value changing.

When setting a parameter value the default value can be selected by pressing both arrow keys at the same time.

The access to the parameter menu and setup menu can be locked with a password. Please refer to the notes in chapter 7.1.3 "Set password".

The RUN and STOP key can be locked by parameter *Local/Remote* **412**. Please refer to chapter 7.3.1 "Control" and 7.5.3.4.1 "Control via reference frequency channel".

6.1.1 Menus

Menu	Functions								
Actual	Shows actual values. An actual value for permanent display during operation can be selected.								
Para	Set parameters. The following selection limits the number of visible and adjustable parameters. <table border="0" style="width: 100%;"> <tr> <td style="padding-right: 10px;">Easy</td> <td>For elementary applications and quick commissioning. Setting options for about 40 ... 50 parameters (dependent on <i>Configuration</i> 30).</td> </tr> <tr> <td>Std</td> <td>For standard applications. Setting options for about 180 parameters.</td> </tr> <tr> <td>Pro</td> <td>For higher requirements. Setting options for about 380 parameters.</td> </tr> </table> The limitation of the number of parameters can also be set via parameter <i>Control level</i> 28 . All actual values are displayed, independent of the control level.	Easy	For elementary applications and quick commissioning. Setting options for about 40 ... 50 parameters (dependent on <i>Configuration</i> 30).	Std	For standard applications. Setting options for about 180 parameters.	Pro	For higher requirements. Setting options for about 380 parameters.		
Easy	For elementary applications and quick commissioning. Setting options for about 40 ... 50 parameters (dependent on <i>Configuration</i> 30).								
Std	For standard applications. Setting options for about 180 parameters.								
Pro	For higher requirements. Setting options for about 380 parameters.								
Local	Control the motor by means of the operator panel. <table border="0" style="width: 100%;"> <tr> <td style="padding-right: 10px;">Poti F</td> <td>Set output frequency (drive speed).</td> </tr> <tr> <td>Poti P</td> <td>Set percentage values. For example in torque control or PID-control.</td> </tr> <tr> <td>Jog</td> <td>Keep pressed RUN-key: The drive operates with fixed set frequency.</td> </tr> <tr> <td>Test</td> <td>For finding errors and defects at the frequency inverter, sensors, the load and the electrical connections.</td> </tr> </table>	Poti F	Set output frequency (drive speed).	Poti P	Set percentage values. For example in torque control or PID-control.	Jog	Keep pressed RUN-key: The drive operates with fixed set frequency.	Test	For finding errors and defects at the frequency inverter, sensors, the load and the electrical connections.
Poti F	Set output frequency (drive speed).								
Poti P	Set percentage values. For example in torque control or PID-control.								
Jog	Keep pressed RUN-key: The drive operates with fixed set frequency.								
Test	For finding errors and defects at the frequency inverter, sensors, the load and the electrical connections.								
Setup	Guided commissioning. Select control method and motor type. Enter motor data. Guided commissioning also for the available communication interfaces. <table border="0" style="width: 100%;"> <tr> <td style="padding-right: 10px;">Full</td> <td>For first commissioning. Entry and measurement of motor data.</td> </tr> <tr> <td>Motor</td> <td>Only motor data measurement.</td> </tr> <tr> <td>Buscon</td> <td>For commissioning of a communication interface.</td> </tr> </table>	Full	For first commissioning. Entry and measurement of motor data.	Motor	Only motor data measurement.	Buscon	For commissioning of a communication interface.		
Full	For first commissioning. Entry and measurement of motor data.								
Motor	Only motor data measurement.								
Buscon	For commissioning of a communication interface.								
Copy	Copy parameters by means of a memory card.								

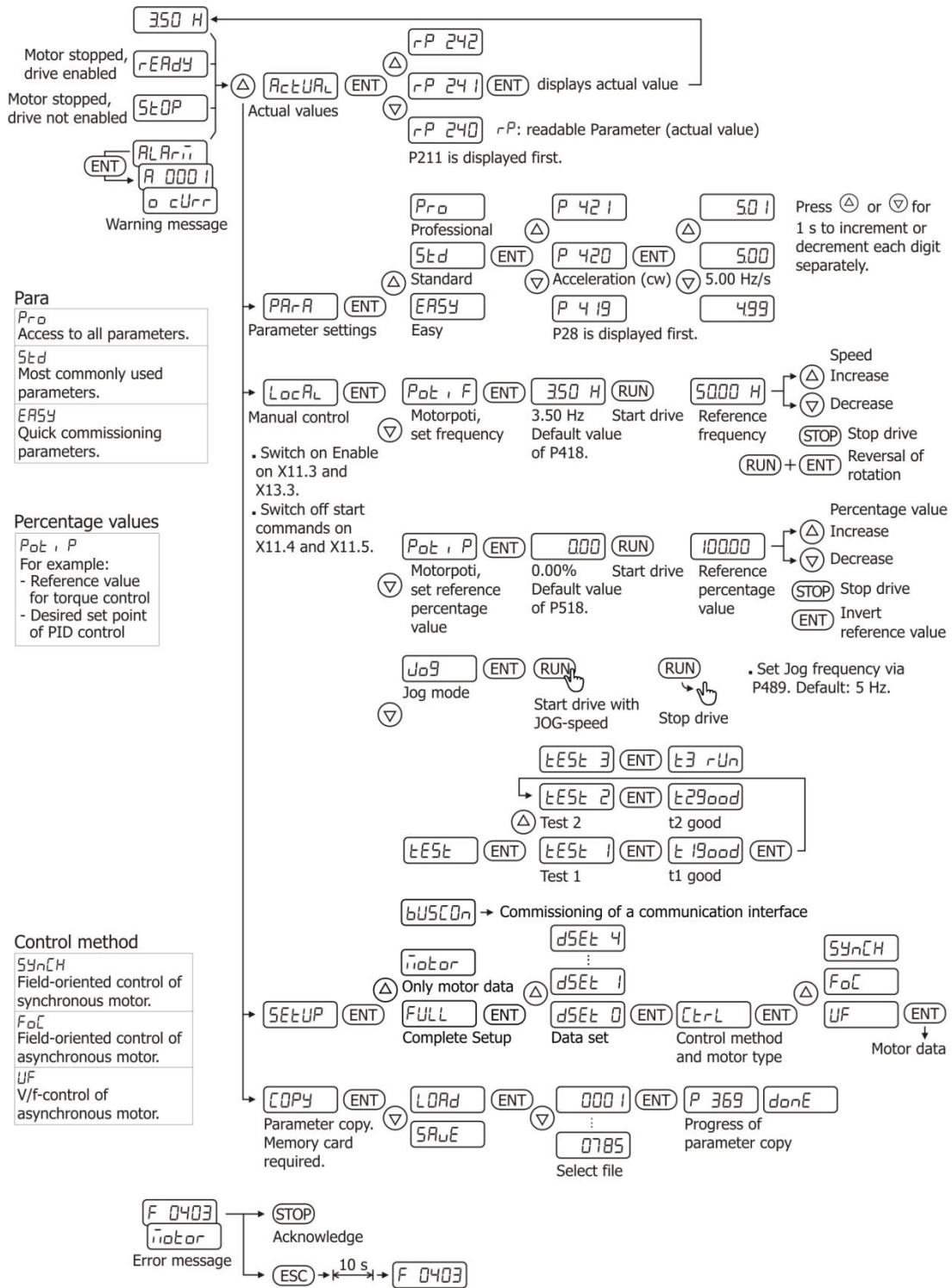

6.1.1.1 Selection of Data sets

The 4 data sets can be set up differently if required. By default all 4 data sets are set up identically.

By default the parameter number is shown. If a dot and a digit is shown in extension to the Parameter number, a data set was already selected or changed individually before.

For the Selection comply with the following steps:

- To change all data sets:
 - Move in the parameter menu to the requested parameter (Up/Down).
 - Check if the parameter number is shown without following dot and digit.
 - Press 1x ENT.
- To change a single data set:
 - Move in the parameter menu to the requested parameter (Up/Down).
 - To select a data set, press and hold ENT and select with Up/Down the requested data set. Release ENT.
 - Press 1x ENT.



Not all parameters are data set changeable. The parameter list in this manual contains all information concerning data sets.



Contains a parameter different values in the data set, the selection of the parameter will automatically show data set 1. If the data sets differ they can only be changed individually via Keypad.

6.1.1.2 Menu for communication setup

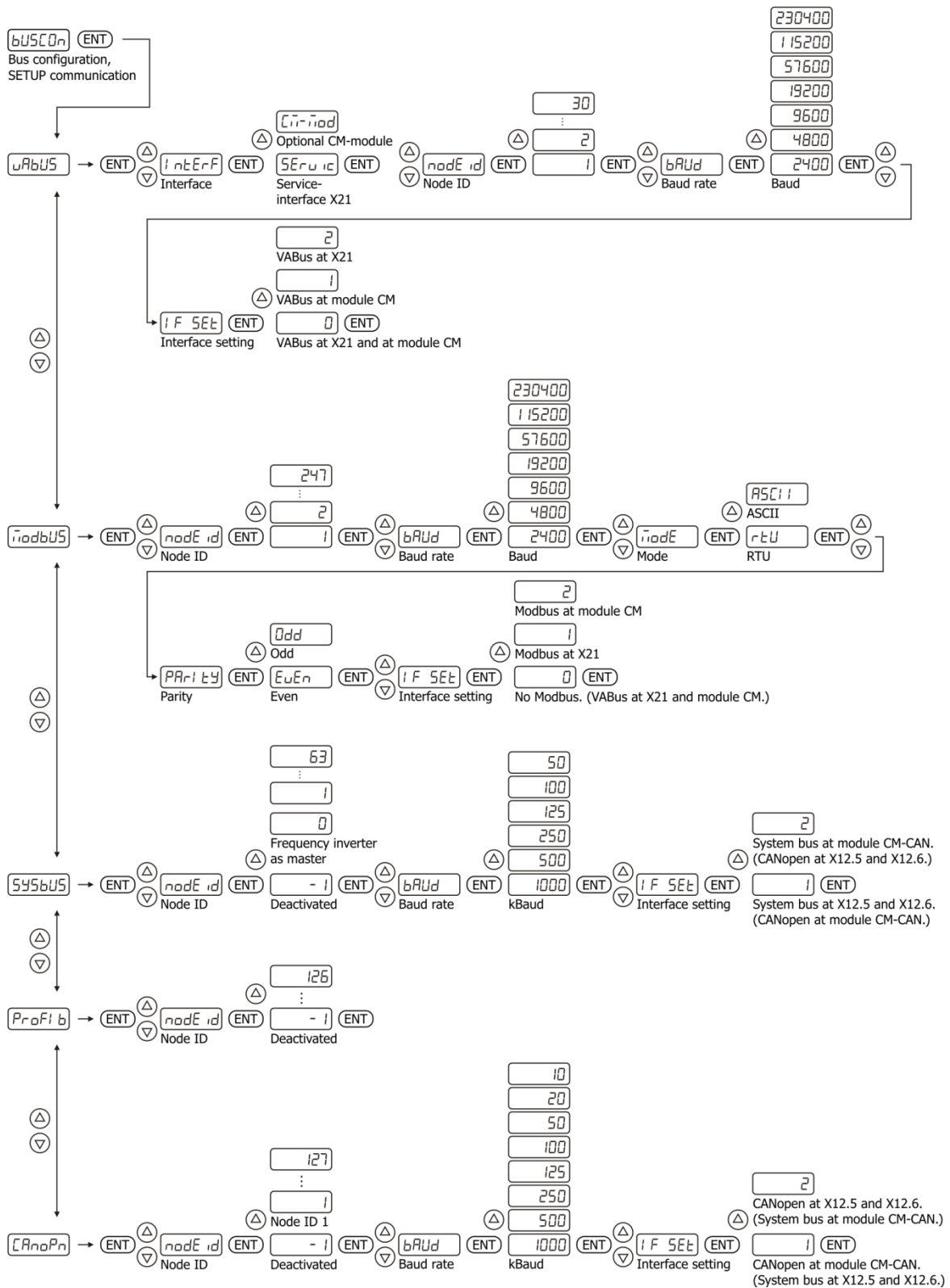

6.1.2 Motor control with operator panel

Poti F - variable frequency

The function Poti F is applicable for variable speed operation.

Select one of the following settings for parameter *Local/Remote* **412**:

- 3 - Control via keypad
- 4 - Control via keypad or contacts(factory setting)
- Select "5 - Keypad motor potentiometer"¹ for parameter *Reference frequency source 1* **475** or *Reference frequency source 2* **492**.
- Switch on enable signals at digital inputs STOA (terminal X11.3) and STOB (terminal X13.3).
- Select **LOCAL** via arrow keys. Confirm by pressing ENT.
- Confirm **Poti F** by pressing ENT.

Start drive	(RUN)	<p>The drive accelerates to the sum of <i>Reference frequency source 1</i> 475 and <i>Reference frequency source 2</i> 492. The displayed value is the totalized reference value.</p> <p><i>Operation mode</i> 493²:</p> <ul style="list-style-type: none"> 0 - Off: 0 Hz. 1 - The reference frequency can be both positive and negative. 2 - Positive only. 3 - Inverted.
Set speed	(▲) (▼)	<p>Increase speed.</p> <p>Decrease speed.</p> <ul style="list-style-type: none"> – Press for a short time to change the frequency by increments of 0.1 Hz. – Keep pressed to change the frequency³ by <i>Ramp Frequency-Motorpoti</i> 473 (factory setting 2 Hz/s). <p>ATTENTION! The change of direction of rotation can occur if <i>Minimum Frequency</i> 418 is set to 0 Hz.</p> <p><i>Minimum Frequency</i> 418 and <i>Maximum Frequency</i> 419 limit the setting range.</p>
Stop drive	(STOP)	The drive stops. <i>Deceleration (clockwise)</i> 421 or <i>Deceleration (anticlockwise)</i> 423 is applied.
Status	(ESC)	Keep pressed for 1 second. The drive status is displayed.
Change direction of rotation	(RUN)+(ENT)	The direction of rotation changes.
Change sign	(STOP) + (ENT)	Sign reversal of the reference value. The direction of rotation is reversed at the next start.

¹ Factory setting of parameter *Reference frequency source 2* **492**. In the factory setting the reference frequency value can be set via operator panel (keypad).

² In the factory setting the reference frequency value can be positive (clockwise rotation) or negative (anticlockwise rotation).

³ Value "0" cannot be set if parameter *Minimum Frequency* **418** (factory setting 3.50 Hz) limits the setting range.

⚠ WARNING



The key RUN starts the drive, if the enable signals at digital inputs STOA (terminal X11.3) and STOB (terminal X13.3) are switched on. The start or stop of the drive is possible, even if menu Poti F is currently not selected. For example the start of the drive is possible if menu PARA for parameter settings or menu ACTUAL for actual value display is selected.

Display of drive status:

350 H

The drive rotates at the reference frequency value. The reference frequency value is the sum of *Reference frequency source 1* **475** and *Reference frequency source 2* **492**.

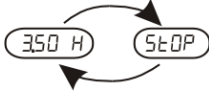

The drive is stopped. The alternating display shows the reference frequency value and the message STOP.





The selection Poti F is only available if the parameter *Local/Remote* **412** was set like described above.

Poti P - variable percentage reference value



The function Poti P is applicable for operation with variable percentage values, in example this is used with the technology controller and the direct torque control.

Select one of the following settings for parameter *Local/Remote* **412**:

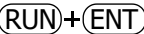
- 3 - Control via keypad
- 4 - Control via keypad or contacts (factory setting)
- Select "5 - Keypad motor potentiometer"¹ for parameter *Reference percentage source 1* **476** or *Reference percentage source 2* **494**.
- Switch on enable signals at digital inputs STOA (terminal X11.3) and STOB (terminal X13.3).
- Select **LoCAL** via arrow keys. Confirm by pressing ENT.
- Select **Pot, P** via arrow keys. Confirm by pressing ENT.

Start drive		<p>The displayed reference value is the sum of <i>Reference percentage source 1</i> 476 and <i>Reference percentage source 2</i> 494.</p> <p><i>Operation mode</i> 495²:</p> <ul style="list-style-type: none"> 0 - Off: 0%. 1 - The reference value can be both positive and negative. 2 - Positive only. 3 - Inverted.
Set percentage value	 	<p>Increase percentage value.</p> <p>Decrease percentage value.</p> <ul style="list-style-type: none"> - Press for a short time to change the frequency by increments of 0.1%. - Keep pressed to change the percentage value by <i>Ramp Percentage-Motorpoti</i> 509 (factory setting: 10%/s). <p>The change of sign can occur if <i>Minimum Frequency</i> 418 is set to 0 Hz.</p> <p><i>Minimum reference percentage</i> 518 and <i>Maximum reference percentage</i> 519 limit the setting range.</p>
Change sign		<p>The sign of the reference percentage value changes. Only possible for torque control (parameter n-/T-Control Change-Over 164).</p>

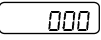
Display of drive status:

	<p>The reference percentage value at rotating drive. The reference percentage value is the sum of <i>Reference percentage source 1</i> 476 and <i>Reference percentage source 2</i> 494.</p>
	<p>The drive is stopped. The alternating display shows the reference percentage value and the message STOP.</p>



The selection Poti P is only available if the parameter *Local/Remote* **412** was set like described above.



¹ Factory setting of parameter *Reference frequency source* **2492**. In the factory setting the reference frequency value can be set via operator panel (keypad).

² In the factory setting the reference percentage value can be positive or negative.

JOG

The function JOG is applicable for fixed speed operation.

- Switch on enable signals at digital inputs STOA (terminal X11.3) and STOB (terminal X13.3).
- If digital inputs are intended for start-signals: Switch off the signals of the parameters *Start clockwise* **68** and *Start anticlockwise* **69**¹.
- Select **LOCAL** via arrow keys. Confirm by pressing ENT.
- Select **JOG** via arrow keys. Confirm by pressing ENT.

Start drive		<p>Keep pressed: The drive accelerates to the <i>JOG frequency</i> 489 (factory setting 5 Hz).</p> <p>For clockwise rotation: Set the <i>JOG frequency</i> 489 to positive values. For anticlockwise rotation: Set the <i>JOG frequency</i> 489 to negative values.</p> <p>Set the acceleration value for clockwise rotation in parameter <i>Acceleration (clockwise)</i> 420. Set the acceleration value for anticlockwise rotation in parameter <i>Acceleration anticlockwise</i> 422.</p> <p>Parameter <i>Maximum frequency</i> 419 limits the adjustable frequency range.</p>
Stop drive		<p>Release the key: The drive decelerates and comes to a standstill.</p> <p>Set the deceleration value for clockwise rotation in parameter <i>Deceleration (clockwise)</i> 421. Set the deceleration value for anticlockwise rotation in parameter <i>Deceleration anticlockwise</i> 423.</p>
Change direction of rotation		<p>The direction of rotation changes. The direction of rotation can be changed while the drive rotates or at standstill.</p>

Display of drive status:

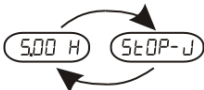

	The drive rotates at <i>JOG frequency</i> 489 .
	<p>The drive is stopped.</p> <p>The alternating display shows the Jog frequency value and the message STOP.</p>



The function JOG can also be activated via a digital input. Refer to chapter 7.5.1.6 "JOG frequency" and 7.6.6.7 "Jog Start". The selection JOG is available independent of the setting of parameter *Local/Remote* **412**.

6.1.3 Set a parameter to the factory setting

Select the parameter number in menu "Para". Confirm by pressing ENT.

	Press simultaneously. The parameter shows now the value of the factory setting.
	Press ENT to confirm this value as the new value for the parameter.

¹ The commands Start clockwise and Start anticlockwise have a higher priority than the start of the function JOG.

6.1.4 Restrict the scope of operation

The scope of operation can be restricted.

Lock the functions start, stop and change direction of rotation at the operator panel: Refer to chapter 7.5.3.4.1 "Control via reference frequency channel".

„

Lock the setting of the reference frequency: Refer to chapter 7.5.1 "Reference frequency channel".

Lock the setting of the reference percentage: Refer to chapter 7.5.2 "Reference percentage channel".

6.2 First commissioning

During commissioning with "Setup/Full" a control method (according to V/f-characteristic or field-oriented control) and the connected motor type (asynchronous or synchronous motor) can be selected. The motor data must be entered according to the motor type-plate. Further motor data is measured automatically. The prompt of basic parameter entries like maximum frequency or acceleration is displayed. After Setup the drive is operational.

Select "Full" setup if the frequency inverter is commissioned for the first time.

Select "Motor" setup if only the motor data are to be measured and other settings are not to be changed.

6.2.1 Overview

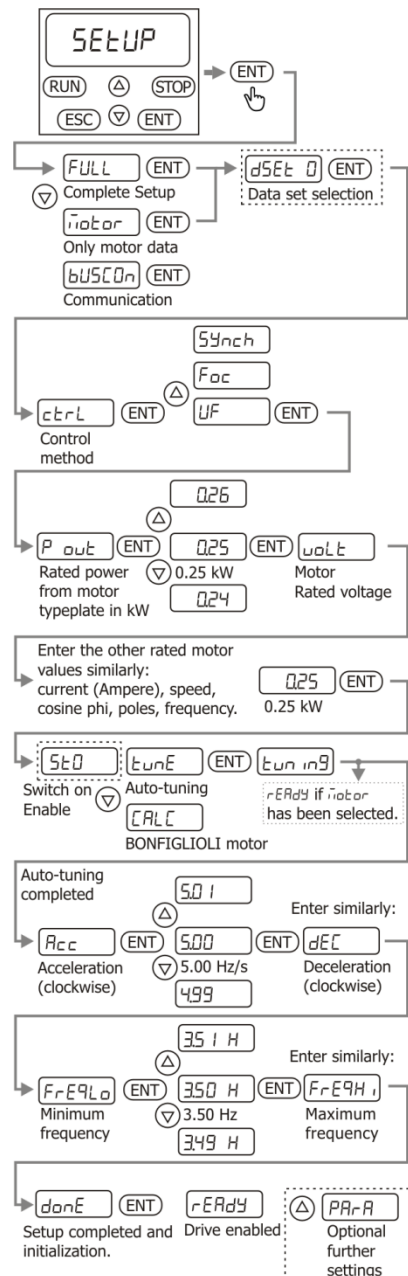

Setup can be selected via menu item "Setup".

After first switch-on Setup is displayed automatically.

<i>FULL</i>	Select for the first commissioning.
<i>Motor</i>	Select for only motor data measuring.
<i>bUSCOm</i>	Select for commissioning of communication.

Data set query is only displayed if Setup is manually selected via the menu item "Setup". Choose data set 0. Another setting is only necessary for setup of various motors.

Control method

<i>UF</i>	Asynchronous motor	V/f-control with variable speed (default).
<i>Foc</i>	Asynchronous motor	Field-oriented control. High drive dynamics and accurate speed control and torque control.
<i>Synch</i>	Synchronous motor	

Motor typeplate (example)

○						
V	Δ/Y	Hz	kW	A	Δ/Y	min ⁻¹
230/400	50	0.25	1.32-0.76	1375	0.77	
↓	↓	↓	↓	↓	↓	↓
uolT	FrEQ	P oUt	ArPErE	SPEEd	coSPH _i	

Press Δ or ∇ for 1 s to increment or decrement each digit separately.

Entry of *coSPH_i* in control method *UF* and *Foc*.

Entry of *PoLP_rS* (number of pole pairs) in control method *Synch*.

<i>tunE</i>	Automatic measurement of further motor data.
<i>CLC</i>	Select if the data of a BONFIGLIOLI motor has been entered. Presetting of further motor data is loaded.
<i>tun in9</i>	Measuring. Wait until <i>rERdy</i> or <i>Rcc</i> is displayed.
<i>5tD</i>	Message only if signal is missing. Set enable signals at X11.3 and X13.3.
<i>SAD0--</i>	Warning.
<i>SFD0--</i>	Error message.

<i>Rcc</i>	Acceleration ramp clockwise. Default 5 Hz/s.
<i>dEC</i>	Deceleration ramp clockwise. Default 5 Hz/s.
<i>FrEQLo</i>	Minimum frequency. Default 3.50 Hz.
<i>FrEQHi</i>	Maximum frequency for speed limitation. Default 50.00 Hz.

Note: The overview shows the sequence for an asynchronous motor.

When commissioning synchronous servo motors, the motor type (BCR, BTD, "Other") has to be selected additionally and the order of the entry of the motor parameters is adjusted.

6.2.2 Start first commissioning of an asynchronous motor

- Switch on enable at STOA (X11.3) and STOB (X13.3).
- Switch off enable at IN1D (X11.4) and IN2D (X11.5), if a circuit for control via control terminals is installed.
- Switch on the power supply.
- Start commissioning (Setup) on operator panel.
 - If the unit is in "as-delivered" condition or after resetting the unit to the factory settings, the guided commissioning procedure is started automatically. The operator panel displays the menu item "Setup". Guided commissioning can also be opened by selecting the "Setup" menu.

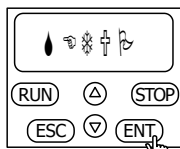

Setup

Parameter

Display
SETUP

Start commissioning.

Using arrow keys, select:



- Complete commissioning or
- Measure motor data only.
- Commissioning of a communication interface
Refer to chapter 6.3 "Commissioning of a communication interface".

FULL or
Motor
BUSCON



NOTE

- Select "Full" setup if the frequency inverter is commissioned for the first time.
- Select "Motor" setup if only the motor data are to be measured and other settings are not to be changed.



Select data set 0.

Select another data set for commissioning of several motors or for different operating points.

dSET 0



P30

Configuration (control method).

ctrl

Using arrow keys, select:



- 110 - IM¹: sensor-less control(SLC) or
- 410 - IM²: sensor-less field-orientated control or
- 610 - PMSM³: sensor-less field-orientated control

UF or
Foc or
Synch



¹ For simple applications (e.g. fans, pumps). Control according to V/f-characteristic. In the case of control via operator panel: Select "UF". IM: Induction machine (asynchronous motor).

² Control of an induction machine (asynchronous motor). For higher demands on speed or torque accuracy. In the case of control via operator panel: Select "Foc".

³ Control of a synchronous motor, for higher demands on speed or torque accuracy. In the case of control via operator panel: Select "Synch". PMSM: Permanently magnetized synchronous motor.

Please note: If you changed the configuration, the device resets.
Please execute the before mentioned steps anew.

Enter motor data according to motor rating plate:

V Δ/Υ	Hz	kW	A Δ/Υ	min ⁻¹	cos φ
230/400	50	0.25	1.32-0.76	1375	0.77

(Example of rating plate)

P376 Rated mechanical power P_{out}
ENT

Set the value using the arrow keys.

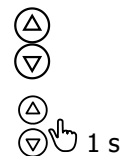

NOTE

Press the arrow keys for 1 s to set each figure individually.

The following rated values are automatically preset if the last set value of rated mechanical power corresponds to a KÜENLE motor. If a KÜENLE motor is connected check and confirm the values.

P370 Rated voltage in V. vOLT
ENT

Rated current in A. AmPERE
ENT

P371 Rated speed in rpm. SPEED
ENT

P372 Rated Cos-Phi
(Enter if 110 "UF" or 410 "FOC" was selected for P30.) coSPh
ENT

P374 Rated frequency in Hz. FREq
ENT

P375 If "STO" is displayed, enable must be switched on via STOA (X11.3) and STOB (X13.3).
Auto-tuning (auto set-up). Confirm to start the measurement of further motor parameters. Consider the following note for another setting option. StD

tune
ENT



NOTE

If a KÜENLE motor is connected and the rated values have been confirmed, "Calc" instead of "tune" is displayed. In this case further motor parameters are not measured. The data is loaded and stored. If instead an auto-tuning should be done, use the arrow keys to switch from "Calc" to "tune".

Calc

Auto-tuning (auto set-up). Further motor parameters are measured automatically if "tune" was selected. tuning

Wait until the auto-tuning operation is complete and the next parameter prompt is displayed.

If "Motor" (measurement of motor data only) was selected at the beginning of the setup procedure, "ready" is displayed.

P420	Acceleration (clockwise) in Hz/s. Ramp gradient. Change rate [Hz/s] of output frequency after a change of the reference value or after a start command.	Acc ENT
P421	Deceleration (clockwise) in Hz/s. Ramp gradient. Change rate [Hz/s] of output frequency after a change of the reference value or after a stop or brake command.	dEC ENT
P418	Minimum Frequency in Hz. Minimum motor speed [Hz]. The frequency will not drop below this value even if a lower reference frequency is selected.	FrEQLo ENT
P419	Maximum Frequency in Hz. Maximum motor speed [Hz]. The frequency will not rise above this value even if a higher reference frequency is selected.	FrEQHi ENT
	Commissioning (Setup) complete and ready for operation. Finish the guided commissioning. The device executes a reset. 2 seconds after the message "done" is visible, the reset is done automatically.	done ENT
	Drive enabled. <ul style="list-style-type: none"> - For further setting options, select "Para" menu or - start the drive. Via the operator panel or via signals at control terminals. 	rEAdY △ PARA
	Start motor via operator panel:	
	Select "local" menu for manual operation.	LocAL
	Select "Poti F" (motor potentiometer) menu.	ENT Pot , F ENT
	Switch on STOA (X11.3) and STOB (X13.3). Press RUN button. The motor is accelerated to the value of P418 (minimum frequency). Factory setting 3.50 Hz. Using the arrow keys, set the speed.	350 H RUN △ ▽
	Start the drive via signals at control terminals:	
	Switch on Start clockwise at IN1D (X11.4) or Start anticlockwise at IN2D (X11.5). The motor is accelerated to the value of P418 (minimum frequency). Factory setting 3.50 Hz. By means of a voltage 0 ... 10 V on MFI1 (X12.3) set the speed. For potentiometer connection refer to chapter 5.7.1 "Circuit for control via control terminals".	

OPTIONAL OPTIMIZATION OF MOTOR CHARACTERISTICS

The motor characteristics are set correctly for most of the applications with the default settings. In some cases optimization of the motor characteristics can be necessary or improve the performance significantly. The optimization possibilities are described in chapter 6.2.10 "Optional Optimization of motor characteristics".

6.2.3 Start first commissioning of a synchronous motor

- Switch on enable at STOA (X11.3) and STOB (X13.3).
- Switch off enable at IN1D (X11.4) and IN2D (X11.5), if a circuit for control via control terminals is installed.
- Switch on the power supply.
- Start commissioning (Setup) on operator panel.

If the unit is in "as-delivered" condition or after resetting the unit to the factory settings, the guided commissioning procedure is started automatically. The operator panel displays the menu item "Setup". Guided commissioning can also be opened by selecting the "Setup" menu.

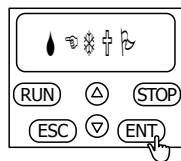

Setup

Parameter

Start commissioning.

Display

SETUP

ENT

Using arrow keys, select:

▲
▼

- Complete commissioning or
- Measure motor data only.
- Commissioning of a communication interface
Refer to chapter 6.3 "Commissioning of a communication interface".

FULL or
Motor
BUSCON



NOTE

- Select "Full" setup if the frequency inverter is commissioned for the first time.
- Select "Motor" setup if only the motor data are to be measured and other settings are not to be changed.

ENT

Select data set 0.

DataSet 0

Select another data set for commissioning of several motors or for different operating points.

ENT

P30	<p>Configuration (control method).</p> <p>Using arrow keys, select:</p> <ul style="list-style-type: none"> - 110 - IM¹: sensor-less control(SLC) or - 410 - IM²: sensor-less field-orientated control or - 610 - PMSM³: sensor-less field-orientated control <p>Please note: If you changed the configuration, the device resets. Please execute the before mentioned steps anew.</p>	<p><i>ctrl</i></p> <p>ENT</p> <p>▲</p> <p>▼</p> <p><i>UF</i> or</p> <p><i>Foc</i> or</p> <p><i>Synch</i></p> <p>ENT</p>
	<ul style="list-style-type: none"> - BCR-motor series of KÜENLE ANTRIEBSSYSTEME - BTD- motor series of KÜENLE ANTRIEBSSYSTEME - Other synchronous servo motor <p>Enter motor data according to the name plate:</p> <p>Standstill Torque M0 in Nm</p> <p>Set the value using the arrow keys.</p>	<p><i>bcR</i> or</p> <p><i>btd</i> or</p> <p><i>othEr</i></p> <p>ENT</p> <p><i>tor9.0</i></p> <p>ENT</p> <p>▲</p> <p>▼</p>
	<div style="display: flex; align-items: center;"> <div> <p>NOTE</p> <p>Press the arrow keys for 1 s to set each figure individually.</p> </div> </div>	<p>▲</p> <p>▼ 1 s</p>
P371	<p>Rated current in A</p> <p>If a BCR or BTD motor of KÜENLE ANTRIEBSSYSTEME was selected, the following data are preselected based on the standstill torque and the rated current. If a KÜENLE motor is connected check and confirm the values. If a motor of another manufacturer was connected, please enter the values manually.</p>	<p><i>RiPErE</i></p> <p>ENT</p>
P370	<p>Rated voltage in V</p> <p>The real AC rated voltage of the motor has to be set up (marked bold in the following). This results in entering:</p> <p>AC 330 V Motor = DC 560 V Motor = AC 400 V FI System voltage</p> <p>AC 200 V Motor = DC 320 V Motor = AC 230 V FI System voltage</p>	<p><i>volt</i></p> <p>ENT</p>
P376	<p>Rated mechanical power in kW.</p> <p>For the BCR and BTD motors, the rated mechanical power is listed in the motor catalogue.</p>	<p><i>P out</i></p> <p>ENT</p>
P372	<p>Rated speed in rpm.</p>	<p><i>SPEEd</i></p> <p>ENT</p>
P373	<p>No. of pole pairs</p>	<p><i>Pol.Prs</i></p> <p>ENT</p>
P375	<p>Rated frequency in Hz</p>	<p><i>FrEQ</i></p> <p>ENT</p>

¹ For simple applications (e.g. fans, pumps). Control according to V/f-characteristic. In the case of control via operator panel: Select "UF". IM: Induction machine (asynchronous motor).

² Control of an induction machine (asynchronous motor). For higher demands on speed or torque accuracy. In the case of control via operator panel: Select "Foc".

³ Control of a synchronous motor, for higher demands on speed or torque accuracy. In the case of control via operator panel: Select "Synch". PMSM: Permanently magnetized synchronous motor.

P1192	Maximum Current	RIP. H, ENT
	If "STO" is displayed, enable must be switched on via STOA (X11.3) and STOB (X13.3).	STO
	Auto-tuning (auto set-up). Confirm to start the measurement of further motor parameters. Consider the following note for another setting option.	tunE ENT
	NOTE If a KÜENLE motor is connected and the rated values have been confirmed, "Calc" instead of "tune" is displayed. If "calc" is selected, no further motor parameters are measured. The data is loaded and stored. If instead an auto-tuning should be done, use the arrow keys to switch from "Calc" to "tune".	CALC ENT

	Auto-tuning (auto set-up). Further motor parameters are measured automatically if "tune" was selected.	tun in9
	Wait until the auto-tuning operation is complete and the next prompt is displayed.	ENT
P383	If Motor "Other" was selected at the beginning of the setup procedure, the determined Voltage constant is displayed. Correct this setting, if the value is known from the motor data sheet. For KÜENLE motors, this step is not necessary and the Voltage constant is set automatically.	U.const
	If the Voltage constant is unknown, set the value to Zero. The Setup will determine the Voltage constant automatically if the value is set to zero.	ENT
	If "Motor" (measurement of motor data only) was selected at the beginning of the setup procedure, "ready" is displayed.	rEAdY
P420	Acceleration (clockwise) in Hz/s Ramp gradient. Change rate [Hz/s] of output frequency after a change of the reference value or after a start command.	Acc
		ENT
P421	Deceleration (clockwise) in Hz/s Ramp gradient. Change rate [Hz/s] of output frequency after a change of the reference value or after a stop or brake command.	dEC
		ENT
P418	Minimum Frequency in Hz. Minimum motor speed [Hz]. The frequency will not drop below this value even if a lower reference frequency is selected.	FrEQLo
		ENT
P419	Maximum Frequency in Hz. Maximum motor speed [Hz]. The frequency will not rise above this value even if a higher reference frequency is selected.	FrEQHi
		ENT
	Commissioning (Setup) complete and ready for operation. Finish the guided commissioning. The device executes a reset. 2 seconds after the message "done" is visible, the reset is done automatically.	done
		ENT
	Drive enabled.	rEAdY
	– For further setting options, select "Para" menu or	△ PARA
	– start the drive. Via the operator panel or via signals at control terminals.	

Start motor via operator panel:

Select "local" menu for manual operation.

Loc Al.
ENT

Select "Poti F" (motor potentiometer) menu.

Pot : F
ENT

Switch on STOA (X11.3) and STOB (X13.3).

Press RUN button.

350 H
RUN

The motor is accelerated to the value of P418 (minimum frequency).

Factory setting 3.50 Hz.

Using the arrow keys, set the speed.

▲
▼

Start the drive via signals at control terminals:

Switch on Start clockwise at IN1D (X11.4) or

Start anticlockwise at IN2D (X11.5).

The motor is accelerated to the value of P418 (minimum frequency).

Factory setting 3.50 Hz.

By means of a voltage 0 ... 10 V on MFI1 (X12.3) set the speed. For potentiometer connection refer to chapter 5.7.1.

OPTIONAL OPTIMIZATION OF MOTOR CHARACTERISTICS

The motor characteristics are set correctly for most of the applications with the default settings. In some cases optimization of the motor characteristics can be necessary or improve the performance significantly. The optimization possibilities are described in chapter 6.2.10.

6.2.4 Status messages during commissioning (SS...)

The following status messages are possible during commissioning (setup):

Status message	Meaning
SS000 OK	Auto setup routine has been carried out.
SS001 PC Phase 1	The plausibility check (PC) of the motor data is active.
SS002 PC Phase 2	The calculation of dependent parameters is active.
SS003 STO	The parameter identification demands enable on digital input STOA and STOB.
SS004 Parameter identification	The rated motor values are checked by the parameter identification feature.
SS010 Setup already active	The setup routine via the operator panel is being carried out.
SS030 No Release	No enable signal. The parameter identification demands enable on digital input STOA and STOB.
SS031 Error	Error during the auto set-up routine. Check the value of <i>Actual error</i> 259 .
SS032 Warning Phase Asymmetry	The parameter identification feature diagnosed an unbalance during the measurements in the three motor phases.
SS099 Setup not carried out	The setup is not carried out until now.

6.2.5 Warnings during commissioning (SA...)

If an error or a warning is signalled during commissioning, the following causes are possible.

Warning Messages		
Code	Message	Meaning
SA001	Rated voltage	The value of the parameter <i>Rated Voltage</i> 370 is out of the rated voltage range of the frequency inverter. The maximum reference voltage is indicated on the nameplate of the frequency inverter.
SA002	Efficiency	For an asynchronous motor, the calculated efficiency is in the limit range. Check <i>Rated Voltage</i> 370 , <i>Rated Current</i> 371 and <i>Rated Power</i> 376 .
SA003	Rated cos-phi	The value entered for parameter <i>Rated Cosine Phi</i> 374 is outside of the normal range (0.6 to 0.95). Correct the value.

Warning Messages		
SA004	Slip frequency	For an asynchronous motor, the calculated slip is in the limit range. Check <i>Rated Speed 372</i> and <i>Rated Frequency 375</i> .
SA021	Stator resistance high value	The following causes are possible: The motor cable cross-section is not sufficient. The motor cable is too long. The motor cable is connected incorrectly.
SA022	Rotor resistance high value	The following causes are possible: The motor cable cross-section is not sufficient. The motor cable is too long. The motor cable is connected incorrectly.
SA041	Rated Slip Correction Factor low value	Check <i>Rated Speed 372</i> and <i>Rated Frequency 375</i> .
SA042	Rated Slip Correction Factor high value	Check <i>Rated Speed 372</i> and <i>Rated Frequency 375</i> .
SA051	Check motor connection	The motor data for star connection were entered, the motor, however, is connected in delta. Change motor cable connections for star connection. Check motor data entered for delta connection. Repeat commissioning (Setup) via operator panel.
SA052	Check motor connection	The machine data for delta connection were entered, the motor, however, is connected in star. Change motor cable connections for delta connection. Check motor data entered for star connection. Repeat commissioning (Setup) via operator panel.
SA053	Check motor connection	Check connections at frequency inverter and motor.

If an error or a warning is signalled:

- Press ESC to correct a parameter value after an error message or warning.
- Press ENT to suppress a warning message. Setup is continued. It is recommended that the entered data be checked.

In the case of problems not triggering an error message, you can try to find an appropriate measure, following the instructions in chapter 13.3 "Troubleshooting".

If errors or warning messages occur during operation, proceed according to the instructions in chapters 13.1.1 "Error messages" and 14.3 "Warning status and warning status application".

6.2.6 Error messages during commissioning (SF...)

If an error or a warning is signalled during commissioning, the following causes are possible.

Error messages		
Code	Message	Meaning
SF001	Rated current too low	The value entered for parameter <i>Rated Current</i> 371 is too low. Correct the value.
SF002	Rated current too high	The value for parameter <i>Rated Current</i> 371 is too high, referred to parameters <i>Rated Power</i> 376 and <i>Rated Voltage</i> 370 . Correct the values.
SF003	Rated cos-phi	The value entered for parameter <i>Rated Cosine Phi</i> 374 is wrong (greater than 1 or smaller than 0.3). Correct the value.
SF004	Negative slip frequency	The calculated slip frequency is negative. Check and, if necessary, correct the values entered for parameters <i>Rated Speed</i> 372 and <i>Rated Frequency</i> 375 .
SF005	Slip frequency too high	The calculated slip frequency is too high. Check and, if necessary, correct the values entered for parameters <i>Rated Speed</i> 372 and <i>Rated Frequency</i> 375 .
SF006	Power balance	The calculated total output of the drive is lower than the rated power. Correct and check, if necessary, the value entered for parameter <i>Rated Power</i> 376 .
SF007	Config. not supported	The set configuration is not supported by the set-up routine.
SF011	Inductance measurement failed	The main inductance measurement has failed because the motor has a high slip. Correct the rated motor values in parameters 370, 371, 372, 374, 375 and 376 . Carry out the set-up routine again. In case an error message is displayed again, enter the value 110 for parameter <i>Configuration</i> 30 (sensorless control according to V/f-characteristic) if value 410 was set so far. Carry out the set-up routine again.
SF012	Inductance measurement failed	The leakage inductance measurement has failed because the motor has a high slip. Correct the rated motor values in parameters 370, 371, 372, 374, 375 and 376 . Carry out the set-up routine again. In case an error message is displayed again, enter the value 110 for parameter <i>Configuration</i> 30 (sensorless control according to V/f-characteristic) if value 410 was set so far. Carry out the set-up routine again.
SF021	Resistance measurement failed	The measurement of the stator resistance did not deliver a plausible value. Check the cables at the terminals of the motor and the frequency inverter for proper connection and check the contacts for corrosion and safe contact. Carry out the set-up routine again.
SF022	Resistance measurement failed	The measurement of the rotor resistance did not deliver a plausible value. Check the cables at the terminals of the motor and the frequency inverter for proper connection and check the contacts for corrosion and safe contact. Carry out the set-up routine again.
SF026	Setup aborted	The setup-routine is aborted.

If an error or a warning is signalled:

- Press ESC to correct a parameter value after an error message or warning.
- Press ENT to suppress a warning message. Setup is continued. It is recommended that the entered data be checked.

In the case of problems not triggering an error message, you can try to find an appropriate measure, following the instructions in chapter 13.3 "Troubleshooting".

If errors or warning messages occur during operation, proceed according to the instructions in chapters 13.1.1 "Error messages" and 14.3 "Warning status and warning status application".

6.2.7 Check direction of rotation



WARNING

The unit may only be connected with the power supply switched off.

Make sure that the frequency inverter is discharged.

Dangerous voltage may be present at the motor terminals and the terminals of the brake resistor even after the frequency inverter has been disconnected from power supply. Wait for some minutes until the DC link capacitors have discharged before starting to work at the unit.

To check if the reference value and the actual direction of rotation of the drive correspond to one another, proceed as follows:

- Operate the drive at low speed, i.e. specify a reference value of approx. 10%.
- Switch on frequency inverter enable briefly:
signal at digital inputs STOA and STOB as well as IN1D (Start clockwise) or
signal at digital inputs STOA and STOB as well as IN2D (Start anticlockwise).
- Check if the motor shaft turns in the required direction.

In case the sense of rotation is wrong, exchange two motor phases, e.g. U and V at the terminals of the frequency inverter. The mains-side connection of the frequency inverter does not affect the sense of rotation of the drive. In addition to checking the drive, the corresponding actual values and operating messages can be read out by means of the operator panel.

NOTICE

When using a synchronous motor (in example BCR-, BTD-motor from KÜENLE) the correct phase sequence must be complied with. A mix up of the phases leads to the loss of the correct motor control and typically a fault message.

6.2.8 Selection of actual value display

During drive operation the display of the operator panel indicates the actual frequency (factory setting). This is the value of parameter *Actual Frequency 241*.

The actual value for permanent display during operation can be selected:

- Select menu "Actual". Confirm by pressing ENT.
- By means of the arrow keys select the number of the parameter the value of which is to be displayed. Confirm by pressing ENT. The value is displayed.
- Press ENT for at least 1 second. The display flashes.

The selected value is displayed permanently during drive operation.

Example: Select the working hours (operating hours in which the output stage of the inverter is active) for permanent display.

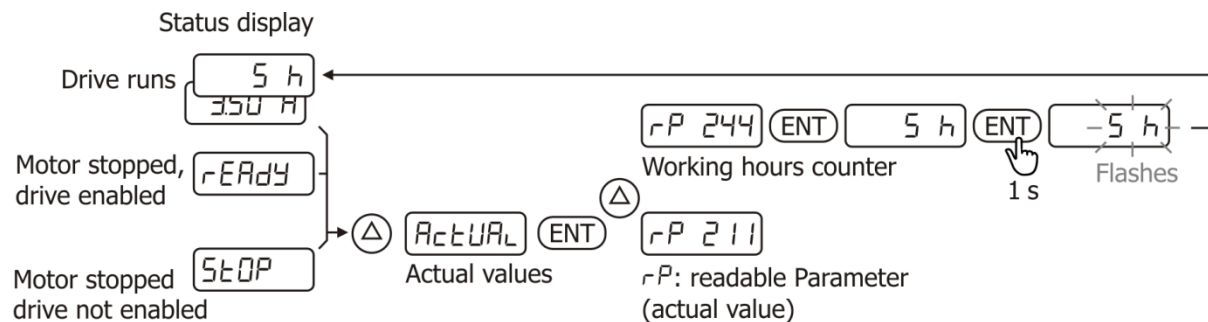

6.2.9 Commissioning without Setup

After electrical connection, the motor (that is selected according to the technical data of the frequency inverter) is ready for operation. The parameters of the frequency inverter must be set to the factory setting. Commissioning by means of Setup with the operator panel is not necessary.

After first switch-on the Setup message is displayed automatically. Select an actual value (for example *Actual Frequency 241*) in menu "Actual" to hide this message.

If the operation should be changed between asynchronous motor (setting 110 or 410 of *Configuration 30*) and synchronous motor (setting 610 of *Configuration 30*) the frequency inverter must be reset to the factory setting. This enables commissioning without Setup via operator panel.

6.2.10 Optional Optimization of motor characteristics

The motor characteristics are set correctly for most of the applications with the default settings. In some cases optimization of the motor characteristics can be necessary or improve the performance significantly.

The following optimizations usually result from the described behaviour:

Objectionable or faulty behaviour:	Controller	Chapter
Overfrequency or Overcurrent error switch off	Speed Controller	6.2.10.1
Motorspeed swings	Speed Controller	6.2.10.1
Motor hums audible	Speed Controller	6.2.10.1
Motor doesn't follow fast enough to a Reference value step	Speed Controller	6.2.10.2
Vibration response at low speeds (often occurs with unknown or inexact motor data)	Voltage Constant	6.2.10.3
Jerky or oscillating behaviour at approx. 5 % of the rated frequency (Transition from current impression to Field oriented control)	Voltage Constant	6.2.10.3
Insufficient Torque during Start of FOC and SYNCH	Starting behaviour	6.2.10.4

6.2.10.1 Speed Controller: Softer set up

If regularly a fault "Overfrequency" or "Overcurrent" occurs or the connected motor hums (even at zero speed) or the motor speed oscillated, then the Speed controller is typically set to dynamic.

Set *Amplification 1* ($|f| < P738$) **721** lower and *Integral Time 1* ($|f| < P738$) **722** higher.

Please note, that *Speed Control Switch-Over Limit* **738** offers different settings of the speed controller for different speed ranges. Above the Switch-Over threshold the parameters *Amplification 2* ($|f| > P738$) **723** and *Integral Time 2* ($|f| > P738$) **724** are effective for the speed controller.



With setting *Speed Control Switch-Over Limit* **738** = 0, *Amplification 1* ($|f| < P738$) **721** and *Integral Time 1* ($|f| < P738$) **722** are effective over the complete frequency range.

Comply with chapter 7.9.5.3 "Speed controller".

6.2.10.2 Speed Controller: Stronger set up

If the motor doesn't follow dynamic enough a reference value step ("load step"), more dynamic settings of the speed controller can enhance the dynamic behaviour.

Set *Amplification 1* ($|f| < P738$) **721** higher and *Integral Time 1* ($|f| < P738$) **722** lower. Please note, that *Speed Control Switch-Over Limit* **738** offers different settings of the speed controller for different speed ranges. Above the Switch-Over threshold the parameters *Amplification 2* ($|f| > P738$) **723** and *Integral Time 2* ($|f| > P738$) **724** are effective for the speed controller.

Comply with chapter 7.9.5.3 "Speed controller".

In different applications the Acceleration Pre-Control can enhance additionally the dynamic behaviour, please comply with the notes in chapter 7.9.5.4.



Depending on the application (inverter power, motor power, gear power, driven load) and its load the frequency inverter might not be able to supply physically the requested power. In this case the dynamic behaviour has to be adjusted to the environmental conditions or the project planning has to be checked.

6.2.10.3 Voltage Constant

After the Setup was completed including the motor tuning, the Voltage constant can be changed manually. If the Voltage Constant is not set optimum, the result might be a jerky or oscillating behaviour at approx. 5 % of the rated frequency (transition from starting current impression to Field Oriented Control, the exact transition point is defined via *Frequency limit* **624**).

Proceed with the Optimization of the Voltage Constant as follows:

- Rotate the motor at approx 50 % of the rated speed without load.
- Check the Actual value *Rotor flux* **225**.
- Change the *Voltage constant* **383** until the *Rotor flux* **225** equals 101 %.



With Motors with a high pole pair number it can occur, that the Voltage constant cannot be entered in the valid value range up to 6500.00 mVmin. In this case you can enter the value with factor 10 smaller. In the device the ratio input voltage/rated speed is validated and the factor 10 is corrected automatically (if necessary).

Comply with chapter 7.2.2 "Further motor parameters".

6.2.10.4 Insufficient Torque during Start of FOC and SYNCH

In the sensorless control the motor rotation is controlled below the *Frequency limit* **624** via a current impression with *Starting current* **623**. Both parameters are set up during the Autotuning. *Frequency limit* **624** is set to approx. 5 % of the Rated frequency. The value can be reduced in most applications. KÜENLE ANTRIEBSSYSTEME recommends to set up the *Frequency limit* **624** always > 2.5 % of the rated frequency and at least 1 Hz. Check your changes via the Scope function.

Starting current **623** affects the Torque during the Start. If the Torque during the Start should be increased, increase *Starting current* **623**.



WARNING

Please note, that a continuous operation with a high Starting current can overload the motor thermally and eventually even destruct the motor. Always check the thermal stability of the motor after increasing the Starting current.

Comply with chapter 7.3.2 "Starting behaviour".

6.2.10.5 Cross coupling compensation

Using permanent excited synchronous motors can require a cross coupling compensation in individual cases for high stator frequencies. This is typically necessary if changes in the speed controller do not result in further improvements in the control behaviour and the control behaviour shows small oscillations at high stator frequencies.

- Rotate the motor at approx 66 % of the rated speed without load.
- Check the Actual value *Isd* **215**.
- Change the *Cross-Coupling Factor* **746** until the oscillations are minimal in *Isq* **225**.

NOTICE

Too high values set as *Cross-Coupling Factor* **746** can result in Overcurrent switch-offs. Change the value in small steps (max. 5 % per step).

6.3 Commissioning of a communication interface

The communication interfaces can be put into operation by means of the menu "Setup" at the operator panel. Even without the knowledge of the parameter number(s) a communication interface can be set up quick and easy. Further communication parameters can be set in the menu "Para". The communication manuals describe the setting options and protocols in detail.

Protocol selection

	Display
Use the arrow keys to select menu "Setup".	<i>SEtUP</i>
	(ENT)
Use the arrow keys to select:	(Δ)
	(▽)
Commissioning of a communication interface(bus configuration)	<i>bUSCOn</i>
	(ENT)
Use the arrow keys to select a protocol:	(Δ)
	(▽)
CANopen	<i>CAnoPn</i>
Profibus ¹	<i>PrOFI b</i>
Systembus	<i>SYSbUS</i>
Modbus	<i>ModbUS</i>
VABus	<i>vAbUS</i>
TCP/IP (Ethernet-Interfaces without EtherCAT®)	<i>tCP-IP</i>
	(ENT)



EtherCAT® doesn't require parameterization at the frequency inverter. The settings are done for EtherCAT® completely via the PLC.

¹Selection is possible only if an optional communication module CM-PDPV1 is installed.

6.3.1 CANopen

Parameter	Display
387 CAN Node Number	<u>nodE_id</u>
385 CAN Baudrate	<u>bAUD</u>
276 CAN interface setting (CM-CAN/X12).	<u>IF SEt</u>
– Set the terminals X12.5 and X12.6 to protocol CANopen.	2
Or:	
– Set an optional communication module CM-CAN to CANopen.	1

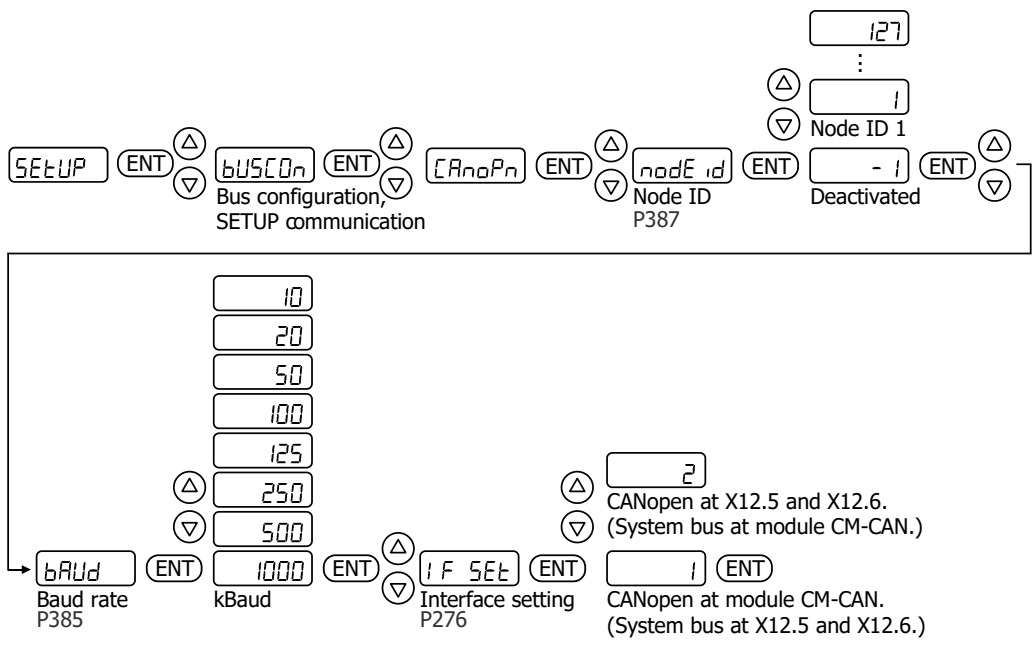

6.3.2 Profibus

Parameter	Display
391 Profibus Node-ID	<u>nodE_id</u>

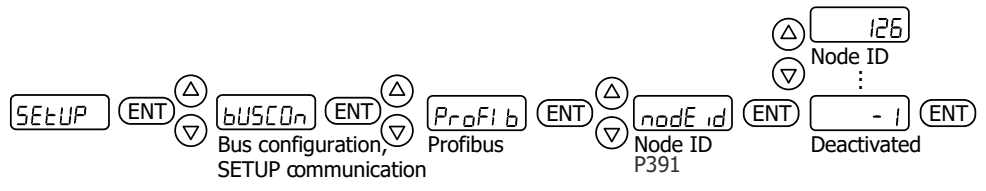

6.3.4 Modbus

Parameter	Display
1376 Modbus Address (Node-ID).	<i>nodE id</i>
1504 Modbus Baudrate	<i>bAUD</i>
1503 Modbus Mode (RTU or ASCII)	<i>ModE</i>
1375 Modbus Parity	<i>PAR ity</i>
395 Interface setting. Protocol (CM/X21).	<i>IF SEt</i>
<ul style="list-style-type: none"> - Set the service interface X21 to Modbus. Or: - Set an optional communication module CM-232 or CM-485 to Modbus. 	1 2

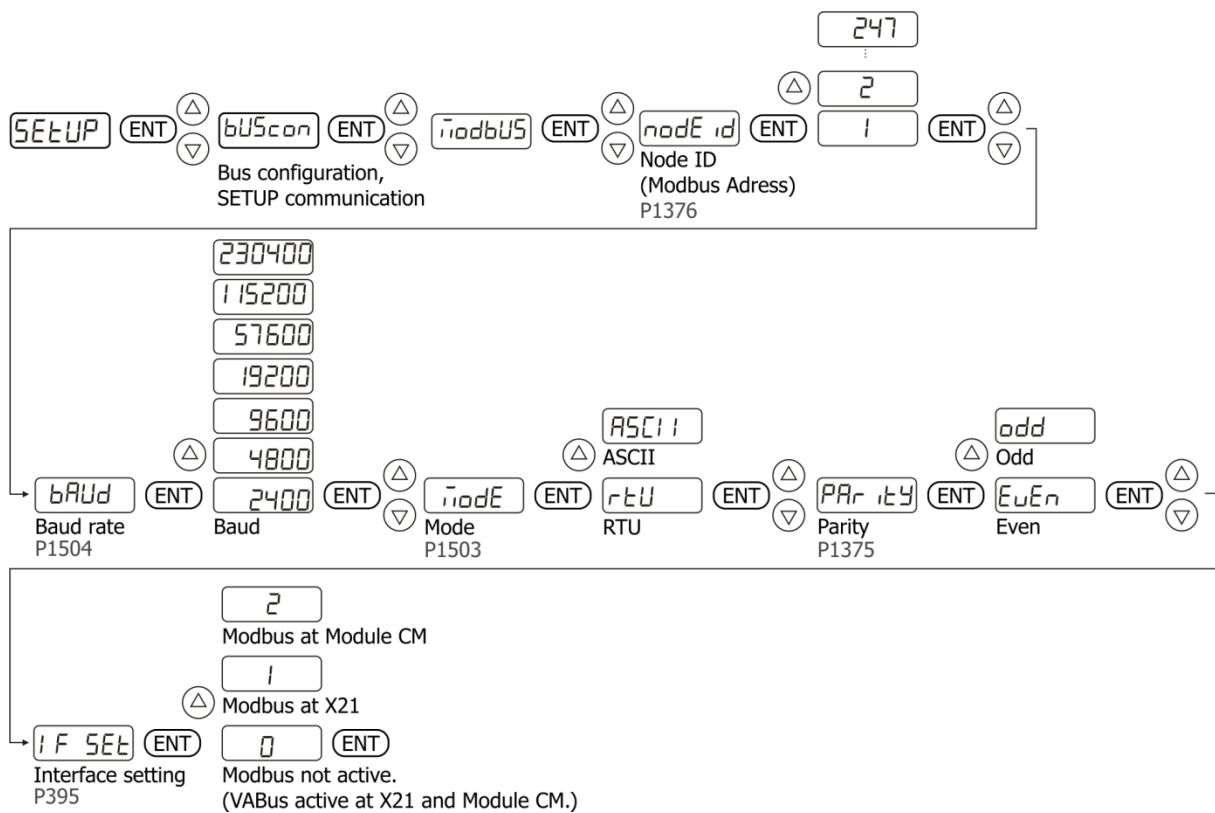

6.3.5 VABus

Parameter	Display
<p>Select the interface for settings of VABus parameters. (Service interface X21 or communication module).</p> <ul style="list-style-type: none"> - Select service interface X21 for VABus communication. Or: - Select an optional communication module CM-232 or CM-485 for VABus communication. The menu item is only displayed if a communication module is installed. 	<p><i>IntErF</i></p> <p><i>SERvIC</i></p> <p><i>CM-Mod</i></p>
394 CM: VABus Node-ID. An optional communication module CM-232 or CM-485 was selected.	<i>nodE id</i>
1501 X21: VABus Node-ID. The service interface X21 was selected.	<i>nodE id</i>
10 Baudrate. An optional communication module CM-232 or CM-485 was selected.	<i>bAUD</i>
1500 Baudrate. The service interface X21 was selected.	<i>bAUD</i>
395 Interface setting. Protocol (CM/X21).	<i>IF SEt</i>
<ul style="list-style-type: none"> - Set the service interface X21 to VABus. Or: - Set an optional communication module CM-232 or CM-485 to VABus. Or: - Set the service interface X21 and an optional communication module CM-232 or CM-485 to VABus. 	<p><i>2</i></p> <p><i>1</i></p> <p><i>0</i></p>

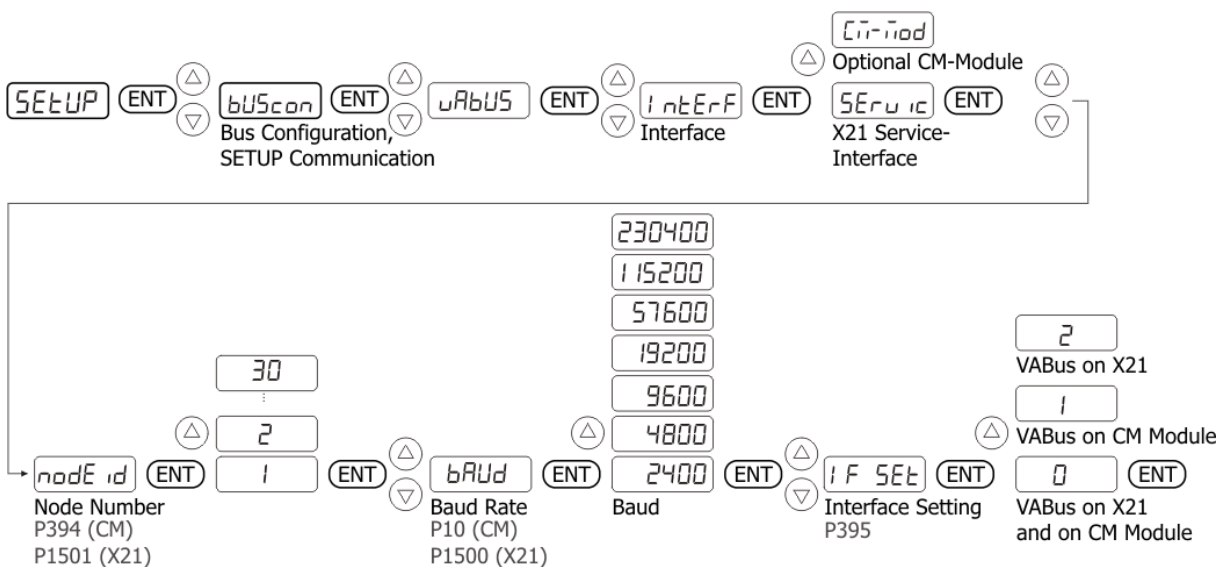

6.3.6 TCP/IP

Parameter		Display
1432	Set up the IP address. This is done in 4 steps. The dots mark the current position.	<i>AddrES</i>
1433	Set up the Subnet mask. This is done in 4 steps. The dots mark the current position.	<i>SUbnEt</i>
1434	Set up the Gateway address. This is done in 4 steps. The dots mark the current position.	<i>gAtE</i>
1435	Set up the DNS server address. This is done in 4 steps. The dots mark the current position.	<i>dnS</i>
1436	If a DHCP Server should and can be used, this setting is used. 0 = Off/Disabled 1 = On/Enabled When the DHCP is enabled, the above settings are not required.	<i>dhCP</i>
	APPLY: Must be used after the configuration of the above settings. Only if the settings are applied, they are taken over. If this was not successful, an error or timeout message might occur.	<i>APPLY</i>
	RELOAD: Reload can be used to reload the default values. If this was not successful, an error or timeout message might occur.	<i>rELoAd</i>

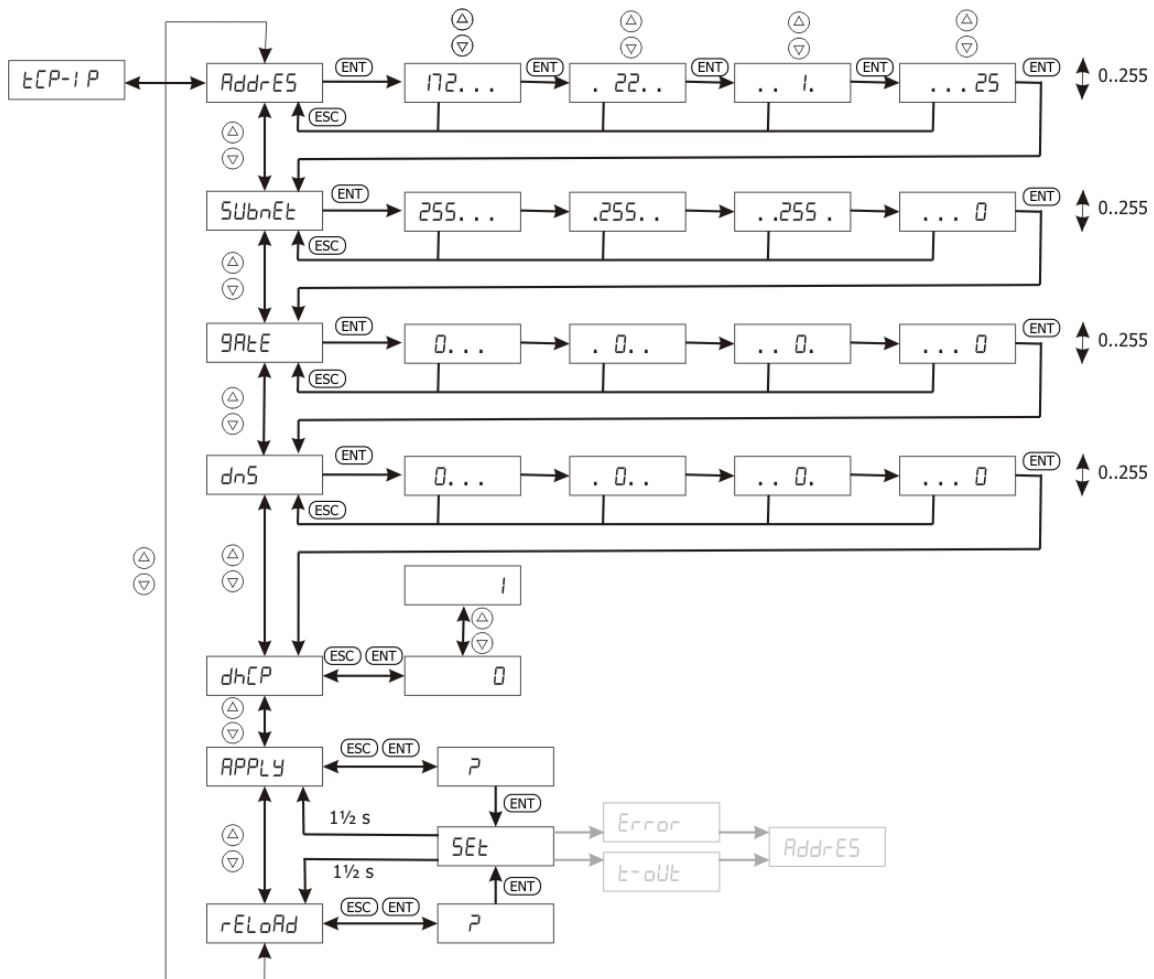

6.4 After first commissioning

After execution of the "Setup" function, the device can be adjusted to the relevant application via the following parameters. Not all setting options are listed. The parameters can be set in the menu "Para".

Control level

Parameter		(Factory setting)
P28	1	Easy: Parameters for quick commissioning.
	2	Standard: The most common parameters can be set.
	3	Professional: Extended access to parameters.

Local/Remote, control via contacts or keypad

P412	0	The commands start, stop and direction of rotation (parameters <i>Start Clockwise 68</i> , <i>Start Anticlockwise 69</i>) can be entered via digital inputs.
	3	The commands start, stop and direction of rotation can be entered via the operator panel.
	4	The commands start, stop and direction of rotation can be entered via the operator panel or via digital inputs. Factory setting.
	5	Control of direction of rotation (parameter <i>Start Clockwise 68</i> , <i>Start Anticlockwise 69</i>) and signal <i>Start 3-Wire Ctrl. 87</i> via digital inputs.
		Further settings are applicable for control via bus system.

Selection of reference frequency

P475 Reference Frequency Source 1. (Factory setting)
 P492 Reference frequency source 2.
 Additional reference value, only for combination of two reference sources.

- | | |
|--------------------------------|-----------------------------|
| 0 Zero | 20 Fieldbus Reference Value |
| 1 Analog Value MFI1A (P475) | 30 Technology Controller |
| 2 Analog Value MFI2A | 40 Electronic gear |
| 3 Fixed Frequency | 2501 PLC-Output Frequency 1 |
| 4 Motorpot. via Digital Inputs | 2502 PLC-Output Frequency 2 |
| 5 Keypad-Motorpot. (P492) | |
| 10 Repetition Frequency | |

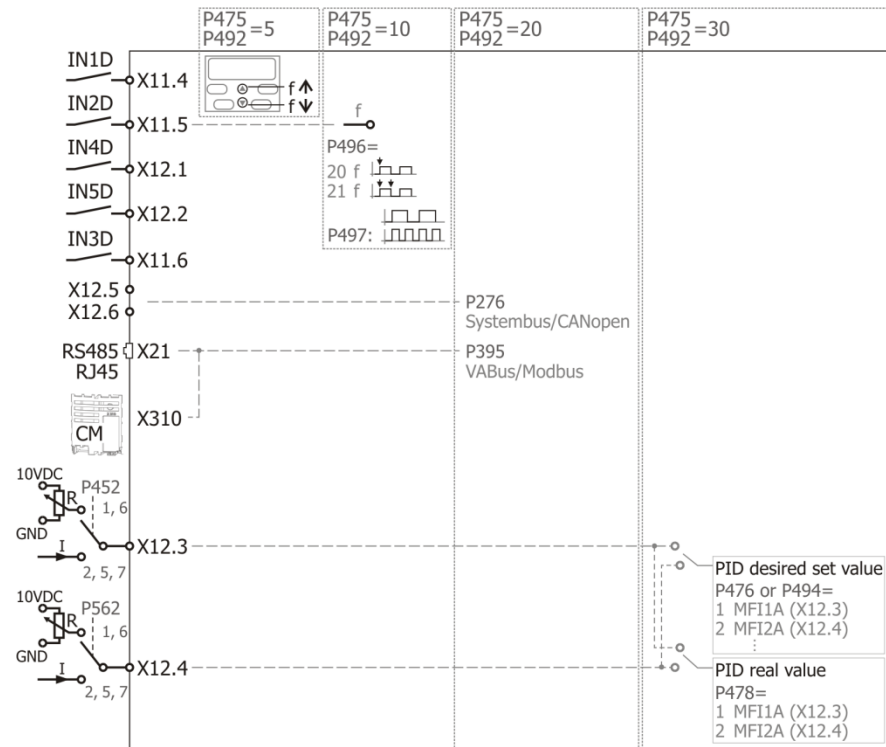
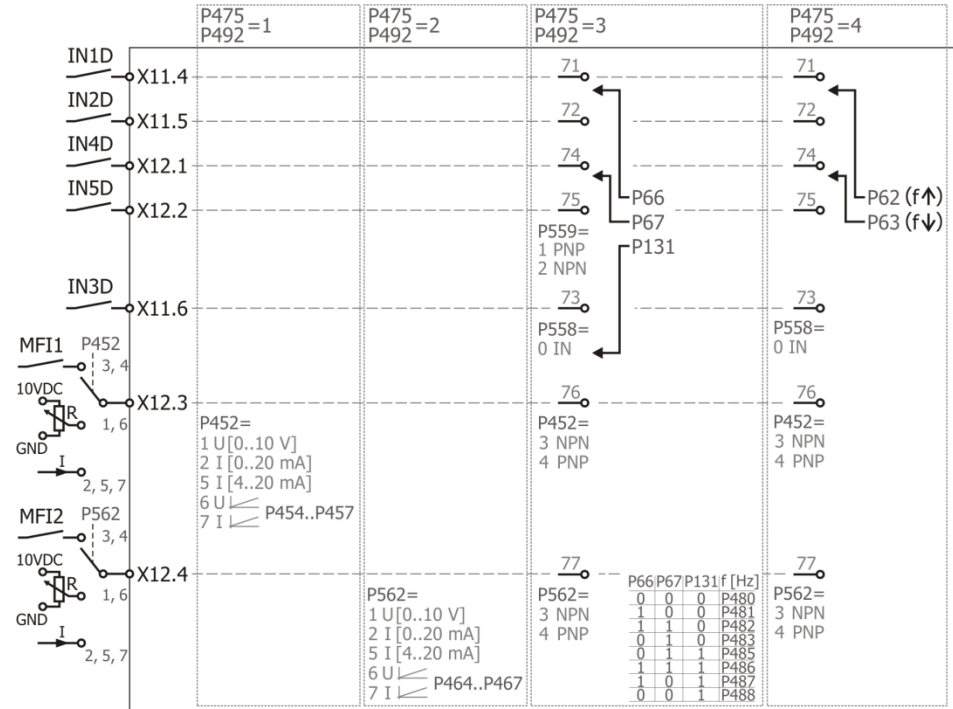

Not all possible reference frequency sources are shown.

Ramp rise time

		(Factory setting)
P430	Accelerated and uniform acceleration and deceleration via S-curve. Thereby the jerk during acceleration and deceleration is reduced. The value is used both for clockwise and anticlockwise operation. (0 ms)	

Torque control

		(Factory setting)
	Reference torque	
P164	6 On	P476 1 Analog Value MFI1A
	7 Off	2 Analog Value MFI2A
	71 Changeover via	3 Fixed Percentage
	... digital inputs	4 Motorpot. via Digital Inputs
		5 Keypad-Motorpot.
	Speed control is switched off when torque control is switched on.	
	P30 must be set to 410 (asynchronous motor) or 610 (synchronous motor).	

Speed control

		(Factory setting)
	Optimize speed controller	
P720	0 Speed controller off	P721 Amplification 1 ($ f < P738$) (10)
	1 Switched on	P722 Integral Time 1 ($ f < P738$) (104 ms)
	Limits	
	P728 Current limit	
	P730 Torque limit	
	P739 Power limit	
	The Speed Control is always limited by the Minimum Frequency (P418) and Maximum Frequency (P419).	
	P30 must be set to 410 (asynchronous motor) or 610 (synchronous motor).	

Digital inputs

			(Factory setting)				
Evaluation logic			Terminal	NPN	PNP		
P559	0	NPN (active: 0 V)	X11.4				
	1	PNP (active: 24 V)	X11.5				
			X12.1				
			X12.2				
			X11.6				
P452	Multi-function MFI1		X12.3				
	3	digital NPN (active: 0 V)					
	4	digital PNP (active: 24 V)					
P562	Multi-function MFI2		X12.4				
	3	digital NPN (active: 0 V)					
	4	digital PNP (active: 24 V)					
				High: ≤ DC 5 V	High: ≥ DC 10 V		
Function							
P[]	7	Off					
	71	IN1D	P68 (Start clockwise)				
	72	IN2D	P69 (Start anticlockwise)				
	73	IN3D	P70 (Data Set Change-Over 1) (P558 = 0 - Input IN3D)				
	74	IN4D	P66 (Fixed Frequency Change-Over 1)				
	75	IN5D	P103 (Error Acknowledgement)				
	76	MFI1D	-				
	77	MFI2D	-				
	532	MFI2D	P204 (Thermo contact for P570) (Hardware)				
	Other possible functions						
P62	Frequency Motorpoti Up		P87	Start 3-Wire Ctrl.			
P63	Frequency Motorpoti Down		P95	Brake Chopper Release			
P67	Fixed Frequency Change-Over 2		P164	n-/T-Control Change-Over			
P71	Data Set Change-Over 2		P183	External Error			
P72	Percent Motorpoti Up		(Not all functions are listed.)				
P73	Percent Motorpoti Down						
P75	Fixed Percent Change-Over 1						
P76	Fixed Percent Change-Over 2						
Assign a function to a digital input (IN1D...IN5D, MFI1D, MFI2D): Select the parameter of the function. Set the parameter to the digital input (selection 71...75, 76, 77).							

Digital outputs

			(Factory setting)	
Function	Terminal	Other possible functions		
P531	2 Run Signal	X13.5	0	Off
P532	103 Inverted Error Signal	X10	1	Ready or Standby Signal
			3	Error Signal
			5	Reference Frequency reached
P533	103 Inverted Error Signal P558 = 1 (output)	X11.6	6	Reference Percentage reached
			7	Ixt-Warning (overload)
			8	Warning Heat Sink Temperature
P554	4 Setting Frequency P550 = 1 (digital)	X13.6	9	Warning Inside Temperature
			10	Warning Motor Temperature
			11	Warning, General
			(Not all functions are listed.)	

Analog inputs

	Multi-function MFI1	Terminal	(Factory setting)
P452	1 Voltage 0...10 V	X12.3	
	2 Current 0...20 mA		
	5 Current 4...20 mA		
	6 Voltage, charact.		
	7 Current, charact.		
P454	Point X1 (2%)		
P455	Point Y1 (0%)		
P456	Point X2 (98%)	X12.4	
P457	Point Y2 (100%)		
P562	Multi-function MFI2		
	1 Voltage 0...10 V		
	2 Current 0...20 mA		
	5 Current 4...20 mA		
	6 Voltage, charact.		
	7 Current, charact.		
P564	Point X1 (2%)		
P565	Point Y1 (0%)		
P566	Point X2 (98%)		
P567	Point Y2 (100%)		

----- Factory setting
 P419: Maximum frequency,
 Reference percentages: Limitation to P519

Set a multifunction input (MFI) as analog input:

	MFI1	MFI2	
Preset characteristic:	P452	P562	= 1, 2 or 5
Define a characteristic:	P452	P562	= 6 or 7 and

Set the characteristic points.

	Frequency	Percentage
	P475 or P492 =	P476 or P494 =
Define reference value:	via MFI1:	1 - Analog Value MFI1A
	via MFI2:	2 - Analog Value MFI2A

Analog outputs

	Multi-function output MFO1	Terminal	(Factory setting)
P550	10 Analog (PWM) MFO1A	X13.6	
P551	Analog: Voltage 100% (10 V)		
P552	Analog: Voltage 0% (0 V)		
P553	7 Abs. Actual Frequency(0 Hz...P419)		

Other possible output values

0 Off	32 Abs. Inside Temperature
10 Abs. Reference Percentage (P476+P494)	33 Abs. Heat Sink Temperature
20 Abs. Iactive (active current)	51 DC-Link Voltage
30 Abs. Pactive (active power)	52 V (output voltage)
31 Abs. T (torque)	(Not all functions are listed.)

Via multifunction output (MFO1), output analog value:
 Set MFO1 as analog output.
 Set the voltage range (0...22 V) for output.
 Select the value to be output.

Motor potentiometer

Control via digital inputs or operator panel.

(Factory setting)

Save the reference value.
The last reference value set via the motor potentiometer is saved. After shut-down and restart, the drive will be accelerated to this value.

P474 0 Not Latching
 1 Latching

P475 Define reference value via motor potentiometer:
Reference frequency source 1
 0 Zero
 4 Motorpot. via Digital Inputs
 5 Keypad-Motorpot.

or
P492 Reference frequency source 2
 0 Zero
 4 Motorpot. via Digital Inputs
 5 Keypad-Motorpot.

Motor potentiometer via digital inputs:
P62 7 Off
P63 71 IN1D
 72 IN2D
 73 IN3D
 74 IN4D
 75 IN5D
 76 MFI1D
 77 MFI2D
 ... other signal sources
Select digital inputs for P62 and P63.
P62 IN[]D: Increase reference value.
P63 IN[]D: Reduce reference value.

Keypad motor potentiometer:
▲ : Increase reference value.
▼ : Reduce reference value.

P473 Ramp for Motor potentiometer (2.00 Hz/s); limited to values from P420 to P423.

Fixed Frequencies

						(Factory setting)
P480	Fixed Frequency 1	(0.00 Hz)				
P481	Fixed Frequency 2	(10.00 Hz)				
P482	Fixed Frequency 3	(25.00 Hz)				
P483	Fixed Frequency 4	(50.00 Hz)				
P485	Fixed Frequency 5	(5.00 Hz)				
P486	Fixed Frequency 6	(10.00 Hz)				
P487	Fixed Frequency 7	(25.00 Hz)				
P488	Fixed Frequency 8	(50.00 Hz)				
P66	7	Off	P66	P67	P131	Selection
P67	71	IN1D	0	0	0	P480
P131	72	IN2D	1	0	0	P481
	73	IN3D (P558: 0 - Input)	1	1	0	P482
	74	IN4D	0	1	0	P483
	75	IN5D	0	1	1	P485
	76	MFI1D(P452: 3 - NPN or 4 - PNP)	1	1	1	P486
	77	MFI2D (P562: 3 - NPN or 4 - PNP)	1	0	1	P487
	...	other signal sources	0	0	1	P488

Via the signal states at the digital inputs, the fixed frequencies can be selected.
P475 or P492: 3 - Fixed Frequency.

The Speed Control is always limited by the Minimum Frequency (P418) and Maximum Frequency (P419).

Blocking Frequencies

		(Factory setting)
Reference frequencies are hidden. Mechanical resonance of the plant can be avoided.		
Two blocking frequencies can be set.		
P447	1st Blocking Frequency (0.00 Hz)	
P448	2nd Blocking Frequency (0.00 Hz)	
P449	Frequency Hysteresis (0.00 Hz)	
Select the frequency range to be hidden.		
In this range, there is no stationary operating point.		

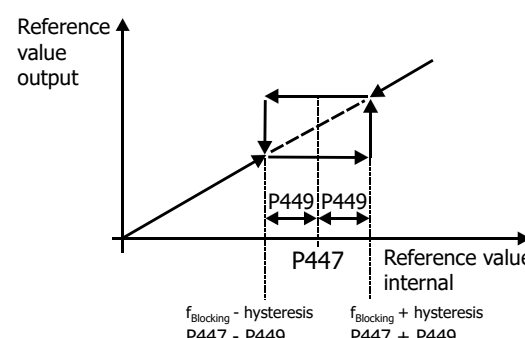

$f_{\text{Blocking}} - \text{hysteresis}$
P447 - P449

$f_{\text{Blocking}} + \text{hysteresis}$
P447 + P449

PWM input

A PWM signal at input IN2D (X11.5) can be used as reference value.			
P496	10	PWM, 0 ... 100%	of P419 (maximum frequency) or of P519 (maximum reference percentage)
	11	PWM, -100 ... 100%	reference percentage)
P652 and P653; for scaling			
P476 or P494: 10 Repetition percentage			
The Speed Control is always limited by the Minimum Frequency (P418) and Maximum Frequency (P419).			

Repetition frequency input

A frequency signal at input IN2D (X11.5) can be used as reference value.			
P496	20	RF (Repetition frequency) single evaluation:	Evaluation One signal edge
	21	RF (Repetition frequency) double evaluation:	Both signal edges
P497 (Divider); for scaling			
P475 or P492:		10	Repetition Frequency Input
The Speed Control is always limited by the Minimum Frequency (P418) and Maximum Frequency (P419).			

Pulse train input

A pulse train signal at input IN2D (X11.5) can be used for specification of the reference value. The frequency of the pulse train signal on the input can be modified via a scaling factor.			
P496	30	Pulse train	
	P654 (scaling frequency)		
	P475 or P492:	10	Repetition frequency
	P476 or P494:	10	Repetition percentage
The Speed Control is always limited by the Minimum Frequency (P418) and Maximum Frequency (P419).			

Starting behaviour (V/f)

		(Factory setting)
		if P30: 110 - IM: sensor-less control (SLC), V/f characteristic
<p>The motor is magnetized (flux-formation, P781) and, if selected, a starting current (P623) is impressed. The IxR compensation compensates the voltage drop at the stator resistor.</p>		
P620	<p>Operation Mode</p> <ul style="list-style-type: none"> 0 Off 1 Magnetization 2 Magnetization + Current Impression 3 Magnetization + IxR-Compensation 4 Magnetization + Current Impression + IxR-Compensation 12 Magnetization + Current Impression with Ramp Stop 14 Magnetization + Current Impression with Ramp Stop + IxR-Compensation 	<p>Control according to V/f characteristic. Set P780 and P781.</p> <p>Set P623, P624, P780 and P781.</p> <p>Set P624, P780 and P781.</p> <p>Set P623, P624, P780 and P781.</p> <p>Set P623, P624, P780 and P781. For high start torque.</p> <p>Set P623, P624, P780 and P781. For high start torque.</p>
P623	<p>Starting Current (value: I_{FIN})¹</p> <p>For sufficient torque if a high start torque is required. The start current is impressed until the output frequency reaches the value of P624.</p>	<p>PI controller for start current</p> <p>P621 P part (2.00)</p> <p>P622 I part (50 ms)</p>
P624	<p>Frequency Limit (2.60 Hz)</p> <p>The starting current is impressed up to this output frequency.</p>	
P780	<p>Max. Flux-Formation Time (300 ms)</p> <p>The current during flux-formation (value of P781) is not impressed longer than this time.</p>	
P781	<p>Current during Flux-Formation (value: I_{FIN})</p> <p>Upon startup, this current value is impressed. The time for current impression is limited by P780.</p>	

¹ Nominal value of frequency inverter

Starting behaviour (field-oriented)

		(Factory setting)
		if P30: 410 - IM: sensor-less field-oriented control" P30: 610 - PMSM: sensor-less field-oriented control"
P623	Starting Current (value: I_{FIN}) ¹	
	For sufficient torque if a high start torque is required. The start current is impressed until the output frequency reaches the value of P624.	
P624	Frequency Limit (2.60 Hz)	
	The starting current is impressed up to this output frequency.	
779	Min. Flux-Formation Time	
	The current during flux-formation (P781) is impressed at least for this time.	
P780	Max. Flux-Formation Time (P30=410: 1000 ms), (P30=610: 50 ms)	
	The current during flux-formation (P781) is impressed not longer than this time.	
P781	Current during flux-formation (value: I_{FIN})	
	Upon startup, this current value is impressed. The time for current impression is limited by P780.	

Stopping behaviour

		(Factory setting)
P630	0	P68 and P69 = 1: Coast to Stop, P68 and P69 = 0: Coast to Stop
	1	P68 and P69 = 1: Coast to Stop, P68 and P69 = 0: Stop and Switch Off
	...	
	<u>11</u>	P68 and P69 = 1: Stop and Switch Off, P68 and P69 = 0: Stop and Switch Off
	...	
	43	P68 and P69 = 1: Emergency Stop and Switch Off, P68 and P69 = 0: Stop and DC brake DC brake (only if P30 = 110): As from standstill, the direct current P631 (braking current) is impressed for the time of P632 (braking time).
Via P68 (Start Clockwise) and P69 (Start Anticlockwise) the motor stopping behaviour is controlled. For state P68 and P69 = logic 1, a stopping behaviour must be selected. For state P68 and P69 = logic 0, a stopping behaviour must be selected.		

¹ Nominal value of frequency inverter

V/f characteristic

(Factory setting)

if P30: 110 - IM: sensorless control

- 606 Type V/f characteristic
- 1 Linear Linear characteristic.
 - 2 Quadratic For applications where the torque increases quadratically to the speed. Suitable for energy saving.

600 Starting Voltage (5.0 V)
Output voltage at output frequency of 0 Hz.

601 Voltage Rise (10%)
Increase of output voltage deviating from linear characteristic.

602 Rise Frequency (20%)
Increase of output voltage deviating from linear characteristic.

603 Cut-Off Voltage (230.0 or 400.0 V)
Coordinate for setting of V/f characteristic.

604 Cut-Off Frequency (50 Hz)
Coordinate for setting of V/f characteristic.

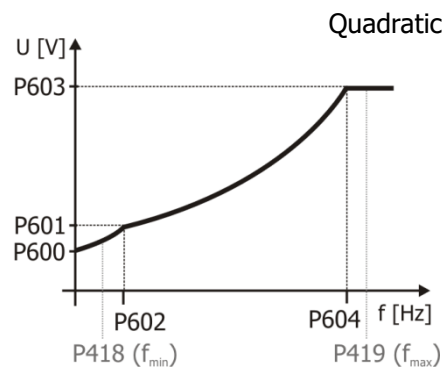
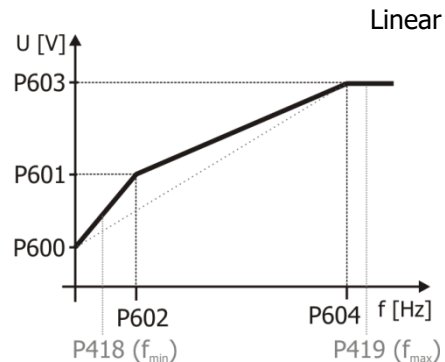

The working range is between P418 (minimum frequency 3.50 Hz) and P419 (maximum frequency 50 Hz).

Motor temperature monitoring

- 570 Evaluate thermo contact at MF12 (X12.4):
- 1 Thermo contact, P204: Warning only
 - 2 Thermo contact, P204: Error Switch-Off
 - 3 Thermo contact, P204: Error Switch-Off 1 minute delayed
- Further evaluations: PTC, KTY, PT1000.

6.5 Typical functions

The tables show a selection of setting options.

Control type and motor type

Control type and motor type can also be selected during commissioning via operator panel (Setup). If the control type is changed, a device reset is executed immediately.

	(Factory setting)	Chapter
V/f characteristic, asynchronous motor	Set P30 to "110 - IM: sensor-less control (SLC)" ¹ . For P606, select "1 - linear" or "2 - quadratic". P600 ... P605: Set V/f characteristic. P620: Set start behaviour. P630: Set stop behaviour.	7.1.2 7.7, 8.1 7.6.7.4 7.3.2 7.3.3
Field-orientated control, asynchronous motor	Set P30 to "410 - IM: sensor-less field-oriented control 2". P780, P781: Set start behaviour. P630: Set stop behaviour. Set functions of field-orientated control.	7.1.2 7.3.2 7.3.3 7.9.5
Field-orientated control, synchronous motor	Set P30 to "610 - PMSM: sensor-less field-oriented control 3". P780, P781: Set start behaviour. P630: Set stop behaviour. Set functions of field-oriented control.	7.1.2 7.3.2 7.3.3 7.9.5

Set motor speed (reference frequency)

	(Factory setting)	Chapter
Operator panel	Set P492 to "5 - Keypad motorpoti". In "Local" menu, select function "Poti F". Using the arrow keys, set the output frequency (motor speed).	7.5.1
Analog input	Set P475 to "1 - analog value MFI1A". Voltage input at MFI1 (terminal X12.3). The motor speed is proportional to the voltage at MFI1.	7.5.1
Fixed Frequencies	Set P475 or P492 to "3 - Keypad motorpoti". In P480 ... P488, set frequency values. For P66, P67, P131, select digital inputs. Select a frequency value via these digital inputs.	7.5.1
Digital signals	Set P475 or P492 to "4 - Motorpoti via digital inputs". For P473, set an acceleration value. For P62 (Motorpoti up) and P63 (Motorpoti down), select digital inputs. Signals at the chosen digital inputs increase the output frequency (motor speed).	7.5.1 7.5.3.3.1 7.6.6.4
Communication interface	The reference frequency is transmitted via a bus system. Set P475 or P492 to "20 - Fieldbus Reference Value".	Protocol ⁴

Acceleration and deceleration

	(Factory setting)	Chapter
Accelerate clockwise and anticlockwise	Can be set separately for clockwise and anticlockwise operation. Clockwise: P420 and P421 Anticlockwise: P422 and P423 Define how fast the output frequency changes if the reference frequency is changed or during startup, stops, or braking operations.	7.5.1.4
S-curve	P430: The drive is accelerated and decelerated more uniformly and load surges are avoided.	7.5.1.4

¹ For simple applications (e.g. fans, pumps). In the case of control via operator panel: Select "UF".

² Control of an induction machine (asynchronous motor). For higher demands on speed or torque accuracy. In the case of control via operator panel: Select "Foc".

³ Control of a synchronous motor. For higher demands on speed or torque accuracy. In the case of control via operator panel: Select "Synch".

⁴ Instructions on relevant protocol.

Reference torque

	(Factory setting)	Chapter
	Set P30 to 410 (asynchronous motor) or 610 (synchronous motor). Set P164 to "6 -On" or to a signal source (e.g. digital input). Via the signal source the changeover to torque control can be effected.	7.1.2 •7.9.5.2 7.6.6.10
Setting via:		
Operator panel	Set P494 to "5 - Keypad-Motorpot." In "Local" menu, select function "Poti P". Using the arrow keys set the reference torque (percentage referred to the nominal motor torque).	7.5.3.4.2
Analog input	Set P476 to "1 - Analog Value MFI1A" (terminal X12.3). Set P452 to "1 - Voltage 0...10 V". The reference torque is proportional to the voltage at MFI1.	7.5.2 7.6.1
Limitation via:		
Limits	P418 Minimum Frequency (only in current impression phase) P419 Maximum Frequency	7.5.1.1
Speed Controller	P767 Frequency Upper Limit P768 Frequency Lower Limit	7.9.5.3.1

Setting inputs and outputs

	(Factory setting)	Chapter
IN1D (X11.4)	Assign signal "71 - IN1D" to a function. (P68)	7.6.6
IN2D (X11.5)	Assign signal "72 - IN2D" to a function (P69) or set as input for PWM, repetition frequency or pulse train via P496.	7.6.6 7.6.7
IN4D (X12.1)	Assign signal "74 - IN4D" to a function. (P71)	7.6.6
IN5D (X12.2)	Assign signal "75 - IN5D" to a function. (P103)	7.6.6
Evaluation logic	P559: Select PNP (active 24 V) or NPN (active: 0 V) for IN1D ... IN5D.	7.6.6
IN3D/OUT3D (X11.6)	P558: Set as input or output.	7.6.4
	Input:	7.6.6
	Output:	7.6.5
Evaluation logic	P559: PNP (active 24 V) or NPN (active: 0 V).	
MFI1 ¹ (X12.3)	P452: Select analog (voltage/current) or digital (PNP/NPN).	7.6.1
	Analog: For setting of reference frequency: Set P475 or P492 to "1 - Analog Value MFI1A". Setting range: P418 ... P419.	7.5.1 7.5.1.1
	For setting of reference percentage ² : Set P476 or P494 to "1 - Analog Value MFI1A". Setting range: P518 ... P519.	7.5.2 7.5.2.1
	Adjustable characteristic if P452 = 6 or 7.	7.6.1.1.2
	Digital: Assign signal "76 - MFI1D" to a function.	7.6.6
MFI2 ³ (X12.4)	P562: Select analog (voltage/current) or digital (PNP/NPN).	7.6.1.2
	Analog: For setting of reference frequency: Set P475 or P492 to "2 - analog value MFI2A". Setting range: P418 ... P419.	7.5.1 7.5.1.1
	For setting of reference percentage ⁴ : Set P476 or P494 to "2 - analog value MFI2A". Setting range: P518 ... P519.	7.5.2 7.5.2.1
	Adjustable characteristic if P462 = 6 or 7.	7.6.2.1.1
	Digital: Assign signal "77 - MFI2D" to a function.	7.6.6
	Temperature monitoring with thermo contact: Set P204 to "532 - MFI2D (Hardware)".	7.6.6.9

¹ Multifunction input 1:

² e.g. for PID controller (P475/P492 = 30 - technology controller") or for the torque controller (P164).

³ Multifunction input 2:

⁴ e.g. for PID controller (P475/P492 = 30 - technology controller") or for the torque controller (P164).

	(Factory setting)	Chapter
	Set P570 to 1, 2 or 3 (motor temperature: warning or error switch-off).	7.4.6
MFO1 ¹ (X13.6)	P550: Select analog, digital, repetition frequency or pulse train output.	7.6.3
	Digital: Select a function via P554.	7.6.3
	Analog: Via P553, select a signal for the output. (7 - Abs. Actual Frequency).	7.6.3
	Repetition frequency: Via P555, select a frequency value for the output. Set P556 for representation of incremental encoder.	7.6.3
	Pulse train: Scale delivered frequency value via P557. The value is referred to P419 (maximum frequency).	7.6.3 7.5.1.1
OUT1D (X13.5)	Select a function via P531. (2 - Run Signal)	7.6.5
OUT2D (X10) Relay	Select a function via P532. (103 - Inv. Error Signal)	7.6.5

Data set for parameter values and motor data

	(Factory setting)	Chapter
	For motor data of different motors or adjustment to different operating points.	
Data set for setup	<p>Select "Setup" menu. Press ENT. The data set selection is displayed. Select the data set where the entered and measured motor data and parameter values are to be saved.</p> <ul style="list-style-type: none"> - Select data set 0 if all data sets are to contain the same parameter values. - Select one of the data sets 1 ... 4 for commissioning of several motors or for different operating points. <p>Example: For auto set-up (auto-tuning) and motor data, select data set 1.</p> <div style="text-align: center;"> </div>	-
Change parameter value	<p>Set parameter values in a certain data set: In menu "Para", select the parameter to be set. Keeping ENT pressed, press arrow key. The last digit shows the data set. Release ENT and press again. Now, you can set the parameter value using the arrow buttons.</p> <p>Example: Set nominal motor voltage P370 in data set 2.</p> <div style="text-align: center;"> </div>	
Switch over data set	Select digital inputs for P70 (73 - IN3D) and P71 (74 - IN4D). Select a data set value via these digital inputs.	7.6.6.11

¹ Multifunction output

PID controller (technology controller)

	(Factory setting)	Chapter
	Process control (e.g. pressure, flow rate, temperature).	
Switch on	Set P475 or P492 to "30 - Technology controller".	7.5.1
Reference Value	For P476 or P494, select the source specifying the reference value.	7.5.2
Actual value	For P478, select the input where the actual value is applied. The actual value can also be received via a communication interface.	7.9.3
Control behaviour	P444 proportional component (amplification), P445 integral component (integral time), P446 differential component (derivative time).	
Start	P68 (71 - IN1D) or P69 (72 - IN2D).	7.6.6.2

Electronic gear

		(Factory setting)	Chapter
	Synchronization of drives.		
Reference value for slave drive	Set P496 to "20 - repetition frequency single evaluation:" or "21 - Repetition frequency double evaluation". IN2D (X11.5) is the frequency input. Set P497 (typically identical to P556 of the master drive).		7.6.7
Switch on	Set P475 or P492 to "40 - electr. gear".		7.5.1
Gear factor	Fixed	Set P689 to "1 - (P. 685 Numerator)/(P. 686 Denominator)". Set P685 and P686.	7.5.4.3.1
	Variable	Set P689 to "2 - (Analog Numerator)/(P. 686 Denominator)" or "3 - (P. 685 Numerator)/(Analog Denominator)". Set the range via P687 and P688. For P476 or P494, select a signal source. Via the signal source the gear factor can be changed during operation.	7.5.4.3.2 7.5.2
Master drive	Output MFO1: Set P550 to "20 - Repetition Frequency MFO1F". For P555, select a frequency source (1- Actual Frequency). Via P556, set the output frequency.		7.6.3

Positioning

	Chapter
P458 to "1 - Reference positioning". The reference point is detected via digital input IN1D (terminal X11.4). In P460, enter the travel distance in motor revolutions.	7.3.7

Logic functions and functions with analog quantities

	Chapter
Via graphic functional block programming or via entries in a table, analog quantities can be influences and logic links to digital signals can be created.	7.6.6.16, PLC ¹

¹ Application manual "PLC".

Monitoring and protective functions

	(Factory setting)	Chapter
Motor Temperature	Temperature monitoring with thermo contact at MFI2. Set P204 to "532 - MFI2D (Hardware)". Set P562 to "3 - Digital NPN (active: 0 V)" or "4 - Digital PNP (active: 24 V)". Set P570 (0 - off) to 1 (warning only), 2 (immediate error switch-off), or 3 (error switch-off 1 minute delayed).	7.6.6.9 7.6.2 7.4.6
	Temperature measurement at MFI2, temperature monitoring and display with KTY measuring resistor or resistor PT1000. Set P617 to a temperature value. If the value is reached, a warning message will be effected or the frequency inverter will be switched off (depending on setting of P570). Set P562 to voltage input or current input.	7.4.6 7.4.6 7.6.2
	PTC Set P570 to 11 (warning), 12 (immediate error switch-off), or 13 (error switch-off 1 minute delayed).	7.4.6
	KTY Set P570 to 21 (warning), 22 (immediate error switch-off), or 23 (error switch-off 1 minute delayed).	7.4.6
	PT1000 Set P570 to 31 (warning), 32 (immediate error switch-off), or 33 (error switch-off 1 minute delayed).	7.4.6
	P226 shows the measured motor temperature. PTC resistor (motor PTC) does not enable temperature measurement. P617 is inoperable for this evaluation. The evaluation is dependent on the used resistor.	9.2
	Motor circuit breaker	7.10.6 7.10.6
	Mains failure	7.9.2
	DC –Link Voltage	7.9.2
	Phase failure	7.4.7

Control mechanical brake

		Chapter
Activation	For addressing a brake via a digital output: Select "41 - Brake release" for one of the parameters 531 (OUT1D), 532 (OUT2D relay), 533 (OUT3D) or 554 (MFO1).	7.6.5.5
Delayed start	Set P625. When the brake release time has elapsed the drive accelerates. This protects the brake against damage.	7.3.2
Shutdown	Via P630, select the stopping behaviour of the drive.	7.3.2

Energy saving

		Chapter
Switch off display	Set a time in P1510. If no key is pressed on the operator panel during this time, the display will be switched off.	8
Switch off functions	Via P1511, select which functions are to be switched off: Operator panel, digital inputs and outputs, communication or fan. The frequency inverter switches the functions off thus reducing power consumption if enable is switched off via digital inputs STOA and STOB.	8
Energy saving function	For P30, "110 - IM sensor-less control (SLC)" or "410 - IM: sensor-less field-oriented control" must be selected. Via P1550, select if the possible energy savings are to be determined automatically or specified via an entered value (P1551). Via P1551, select which digital input or logic signal is to be used for starting the energy saving function.	8.1
Quadratic V/f characteristic	For load behaviour with torque increasing quadratically to speed (e.g. fan). For control according to V/f characteristic. For P30, "110 - IM sensor-less control (SLC)" must be selected. Via P606, set the characteristic to "2 - quadratic". Set up the V/f characteristic using parameters 600 ... 604.	8.2
Other	E.g. temperature-controlled fans, automatic switch frequency changeover, energy-optimized braking.	8.4

Service

		Chapter						
Service interval	The time remaining until service of DC link (P1530) and fan (P1531) can be displayed.	10.3						
	If the time is expired, a message in P1533 or a warning will be output. The reaction can be set up.	<table border="1" style="width: 100%; border-collapse: collapse;"> <tr> <td style="width: 30%;">DC-Link:</td> <td style="width: 20%;">P1534</td> <td style="width: 50%; text-align: right;">10.3.1</td> </tr> <tr> <td>Fan:</td> <td>P1535</td> <td style="text-align: right;">10.3.2</td> </tr> </table>	DC-Link:	P1534	10.3.1	Fan:	P1535	10.3.2
DC-Link:	P1534	10.3.1						
Fan:	P1535	10.3.2						

Test functions

		Chapter
	For finding errors and defects at the frequency inverter, sensors, the load and the electrical connections.	
Earth fault/short circuit test	Test for earth fault or short-circuit with DC link potential.	7.2.3.1
Load test	Test of IGBTs, the load (e.g. for short circuit), current measurement and for broken cables.	7.2.3.2
Start test	With operator panel Switch on enable at inputs STOA and STOB. Select menu item "Test" in "Local" menu. Select test 1. Comply with the instructions in chapter 7.2.3.1 "Earth fault and short circuit test (Test 1)".	7.2.3.3
	With PC software VPlus Via P1540, select "11 - Start Test 1" or "12 - Start Test 2".	7.2.3.4
Automatic test	Via P1542, select which test is to be started each time after an error switch-off.	7.2.3.5
		Chapter
Test of fan	The function of the fans is tested	
Start test	With operator panel Switch on enable at inputs STOA and STOB. Select menu item "Test" in "Local" menu. Select Test 3. Press ENT. The fans must rotate. Press ESC.	7.2.3.6

Communication

	(Factory setting)	Instructions
CAN System bus	Interface at terminals X12.5 and X12.6.	System-bus
CANopen®	<ul style="list-style-type: none"> – Protocol via terminals X12.5 and X12.6 or – Interface at optional communication module CM-CAN. <p>For parameter <i>CAN Interface (CM-CAN/X12)</i> 276, select the protocol for terminals X12.5/X12.6 or for the communication module. You can choose either CAN system bus or CANopen®.</p>	CANopen
Modbus (RTU/ASCII) VABus	<ul style="list-style-type: none"> – Interface at connection X21 (RJ45 socket) or optional communication module CM-232 or CM-485. – Interface at connection X21 (RJ45 socket) or optional communication module CM-232 or CM-485. 	Modbus
	Via parameter <i>Protocol (CM/X21)</i> 395 , select the protocol for terminal X21 or for the communication module. You can choose either Modbus or VABus. If Modbus is selected, choose either RTU or ASCII via parameter <i>Modbus Mode</i> 1503 .	VABus
Profibus-DP	Optional communication module CM-PDPV1.	PDP-V1
TCP/IP	Optional communication module with Ethernet communication TCP/IP	Ethernet module

6.6 Error Acknowledgment via keypad

If a fault occurs, a device reset can be executed via the STOP key. A reset via the STOP key can only be executed, if Parameter *Local/Remote* **412** allows the control via keypad (see chapter 7.3 “Operational Behaviour”).

Further possibilities to execute a fault reset are described in chapter 7.6.6.8 “Error Acknowledgment”.

6.7 Applications

The parameters required for typical applications are listed. Selecting an application makes commissioning easier. Depending on the application, additional settings may be required.

NOTE

The PC software VPlus provides application masks for easy commissioning of applications.

6.7.1 Pump

Parameters		Recommended setting
30	Configuration	110 IM: sensorless control (V/f characteristic)
420	Acceleration (clockwise)	10 Hz/s
421	Deceleration (clockwise)	-0.01 Hz
492	Reference frequency source 2	0 - Zero
493	Operation mode (reference frequency source)	1 - (+/- reference)
418	Minimum frequency	10 Hz
419	Maximum frequency	53 Hz
420	Acceleration (clockwise)	10 Hz/s
447	1st Blocking frequency	0 Hz
449	Frequency Hysteresis	0 Hz
475	Reference frequency source 1	1 - Analog Value MFI1A
606	Type V/f characteristic	2 - quadratic
630	Operation mode (P68&P69=1 P68&P69=0) (stopping behaviour)	11 - (Stop, Off Stop, Off)
651	Operation mode (auto start)	0 - Off
1550	Operation mode energy saving function	2 - Automatic
1552	Energy saving function on	163 - Reference Frequency reached
68	Start Clockwise	71 - IN1D
69	Start Anticlockwise	7 - Off
531	Operation mode OUT1D (X13.5) (digital output)	2 - Run signal
532	Operation mode OUT2D (X10/relay)	103 - Inv. error signal

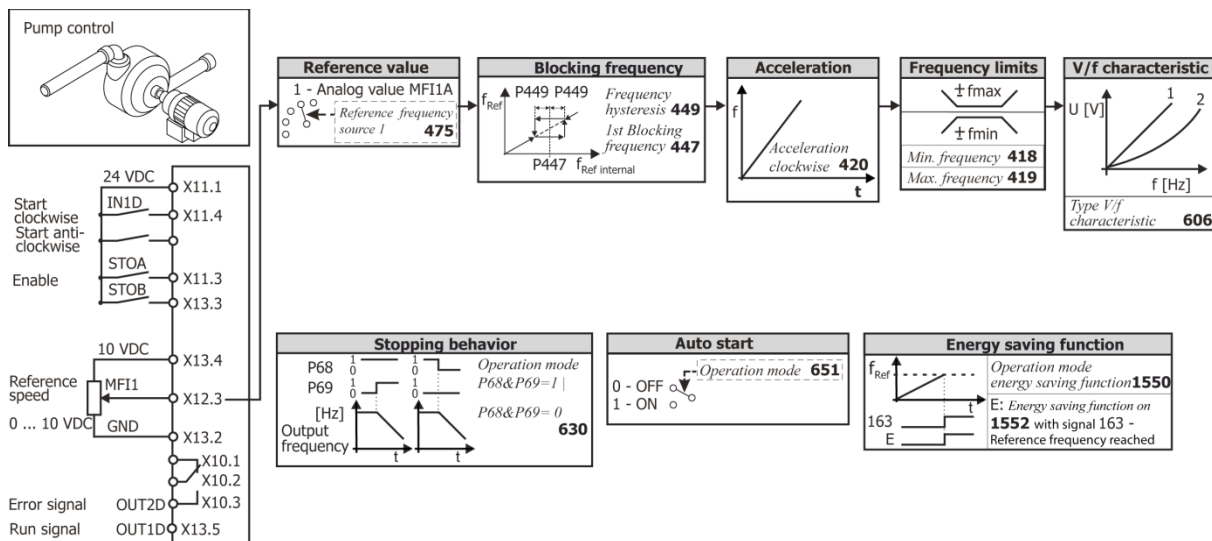

6.7.2 Fan

Parameters		Recommended setting
30	Configuration	110 IM: sensorless control (V/f characteristic)
68	Start Clockwise	71 - IN1D
421	Deceleration (clockwise)	-0.01 Hz
492	Reference frequency source 2	0 - Zero
493	Operation mode (reference frequency source)	1 - (+/- reference)
418	Minimum frequency	10 Hz
419	Maximum frequency	53 Hz
420	Acceleration (clockwise)	50 Hz/s
447	1st Blocking frequency	0 Hz
475	Reference frequency source 1	1 - Analog Value MFI1A
606	Type V/f characteristic	2 - quadratic
630	Operation mode (P68&P69=1 P68&P69=0) (stopping behaviour)	0 - (Coast to Stop Coast to Stop)
645	Operation mode Flying Start	2 - On, according to reference
651	Operation mode (auto start)	0 - Off
1550	Operation mode energy saving function	2 - Automatic
1552	Energy saving function on	163 - Reference Frequency reached
68	Start Clockwise	71 - IN1D
69	Start Anticlockwise	7 - Off
531	Operation mode OUT1D (X13.5) (digital output)	2 - Run signal
532	Operation mode OUT2D (X10/relay)	103 - Inv. error signal

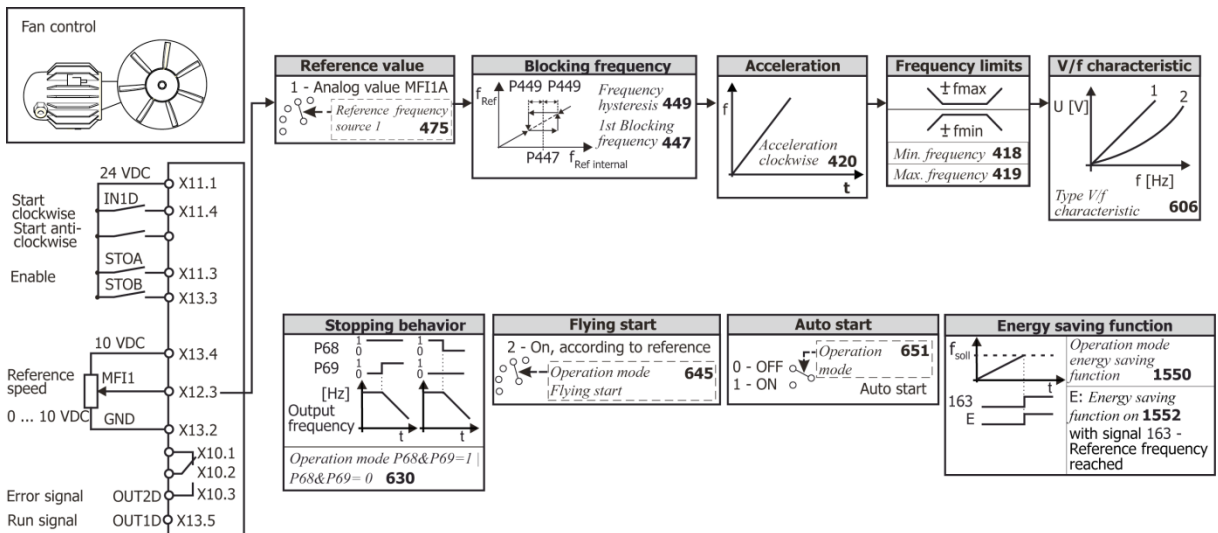

6.7.3 Fan or pump with closed control loop

Parameters		Recommended setting
30	Configuration	110 IM: sensorless control (V/f characteristic)
480	Fixed frequency 1	0 Hz
418	Minimum frequency	10 Hz
419	Maximum frequency	53 Hz
420	Acceleration (clockwise)	5 Hz/s
421	Deceleration (clockwise)	-0.01 Hz
440	Operation mode actual value failure	1 - active, fixed frequency 1
441	Max. I component	50 Hz
442	Maximum frequency	53 Hz
443	Minimum frequency	0 Hz
444	Amplification	1
445	Integral time	1000 ms
446	Derivative time	0 ms
447	1st Blocking frequency	0 Hz
449	Frequency Hysteresis	0 Hz
475	Reference frequency source 1	30 - Technology Controller (PID controller)
476	Reference percentage source 1	2 - Analog Value MFI2A
478	Actual percentage source	1 - Analog Value MFI1A
480	Fixed frequency 1 (in case of actual value failure)	0 Hz
492	Reference frequency source 2	0 - zero
493	Operation mode (reference frequency source)	1 - (+/- reference)
494	Reference percentage source 2	0 - zero
495	Operation mode (reference percentage source)	2 - positive only
606	Type V/f characteristic	2 - quadratic
618	Backlash	0%
630	Operation mode (P68&P69=1 P68&P69=0) (stopping behaviour)	0 - (Coast to Stop Coast to Stop)
651	Operation mode (auto start)	0 - Off
1550	Operation mode energy saving function	Automatic
1552	Energy saving function on	163 - Reference Frequency reached
68	Start Clockwise	71 - IN1D
69	Start Anticlockwise	72 - IN2D
531	Operation mode OUT1D (X13.5) (digital output)	2 - Run signal
532	Operation mode OUT2D (X10/relay)	103 - Inv. error signal

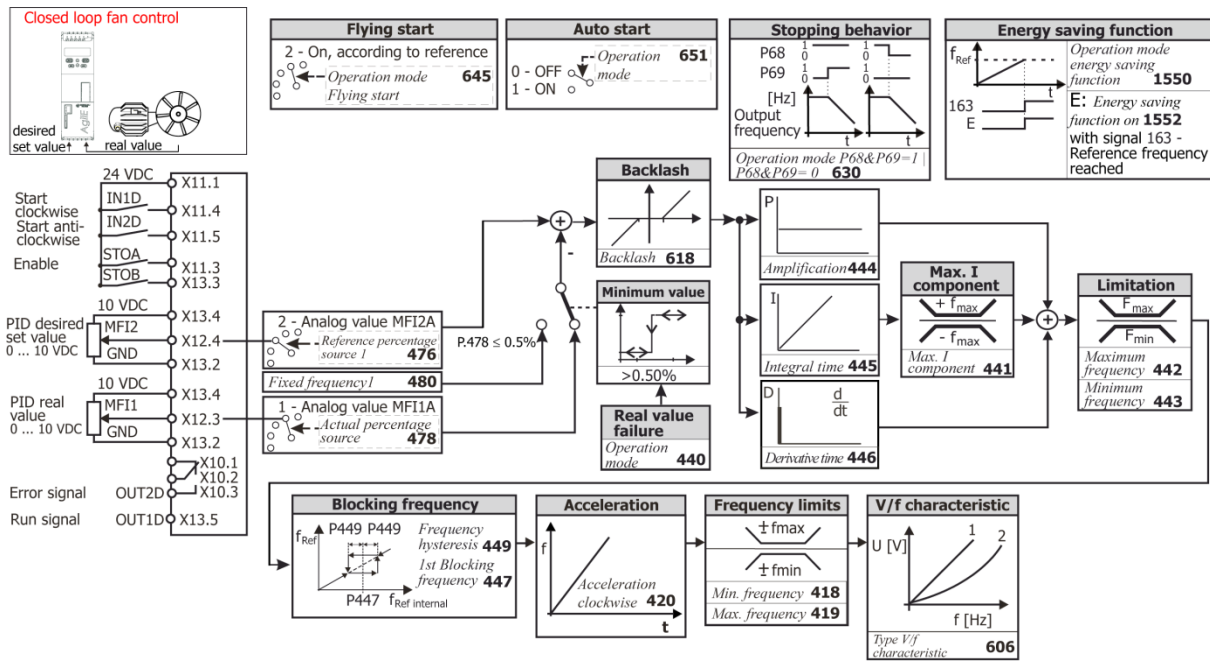

6.7.4 Fan for heating, ventilation, air conditioning system

Parameters		Recommended setting
30	Configuration	110 IM: sensorless control (V/f characteristic)
418	Minimum frequency	10 Hz
419	Maximum frequency	50 Hz
420	Acceleration (clockwise)	10 Hz/s
421	Deceleration (clockwise)	-0.01 Hz
447	1st Blocking frequency	0 Hz
449	Frequency Hysteresis	0 Hz
475	Reference frequency source 1	1 - analog value MFI1A
492	Reference frequency source 2	0 - zero
493	Operation mode (reference frequency source)	1 - (+/- reference)
558	Operation mode terminal X11.6 (digital input/output)	1 - Output OUT3D
573	Operation mode (intelligent current limits)	11 - Ixt + Tc (limitation to overload and max. heat sink temperature)
606	Type V/f characteristic	2 - quadratic
630	Operation mode (P68&P69=1 P68&P69=0) (stopping behaviour)	0 - (Coast to Stop Coast to Stop)
645	Operation Mode Flying Start	2 - On, according to reference
651	Operation mode (auto start)	1 - On
1550	Operation mode energy saving function	Automatic
1552	Energy saving function on	163 - Reference Frequency reached
68	Start Clockwise	71 - IN1D
69	Start Anticlockwise	7 - Off
531	Operation mode OUT1D (X13.5) (digital output)	2 - Run signal
532	Operation mode OUT2D (X10/relay)	103 - Inv. error signal
533	Operation mode OUT3D (X11.6) (digital input/output)	25 - Warning Mask

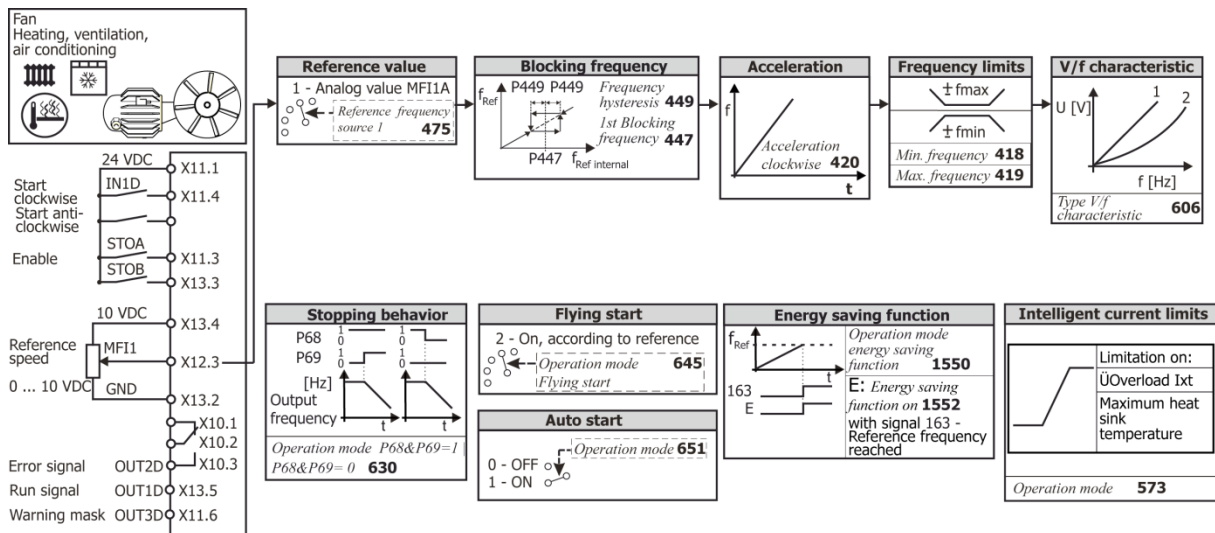

6.7.5 Conveying plant

Parameters		Recommended setting
30	Configuration	110 IM: sensorless control (V/f characteristic)
418	Minimum frequency	10 Hz
419	Maximum frequency	53 Hz
420	Acceleration (clockwise)	5 Hz/s
421	Deceleration (clockwise)	5 Hz/s
447	1st Blocking frequency	0 Hz
449	Frequency Hysteresis	0 Hz
475	Reference frequency source 1	1 - Analog Value MFI1A
492	Reference frequency source 2	0 - zero
493	Operation mode (reference frequency source)	1 - (+/- reference)
630	Operation mode (P68&P69=1 P68&P69=0) (stopping behaviour)	0 - (Coast to Stop Coast to Stop)
645	Operation Mode Flying Start	2 - On, according to reference
68	Start Clockwise	71 - IN1D
69	Start Anticlockwise	7 - Off
531	Operation mode OUT1D (X13.5) (digital output)	2 - Run signal
532	Operation mode OUT2D (X10/relay)	103 - Inv. error signal

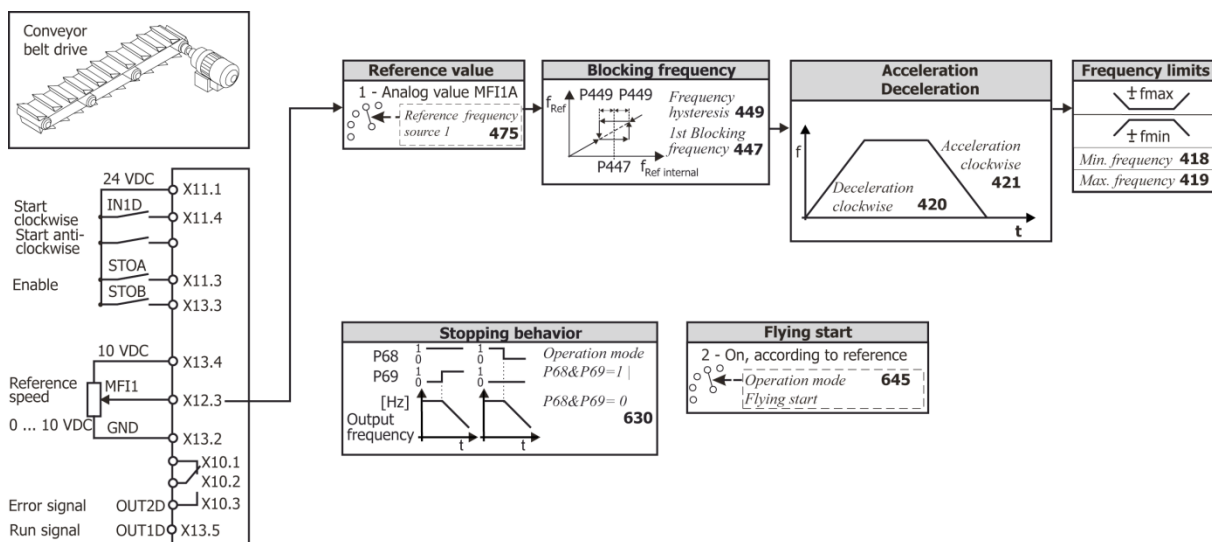

6.7.6 Compressor

Parameters		Recommended setting
30	Configuration	110 IM: sensorless control (V/f characteristic)
418	Minimum frequency	10 Hz
419	Maximum frequency	50 Hz
420	Acceleration (clockwise)	12.5 Hz/s
421	Deceleration (clockwise)	-0.01 Hz
447	1st Blocking frequency	0 Hz
449	Frequency Hysteresis	0 Hz
475	Reference frequency source 1	1 - Analog Value MFI1A
492	Reference frequency source 2	0 - zero
493	Operation mode (reference frequency source)	1 - (+/- reference)
630	Operation mode (P68&P69=1 P68&P69=0) (stopping behaviour)	0 - (Coast to Stop Coast to Stop)
670	Operation mode (voltage controller)	3 - Ud limitation and mains support active (Ud: DC link voltage)
68	Start Clockwise	71 - IN1D
69	Start Anticlockwise	7 - Off
531	Operation mode OUT1D (X13.5) (digital output)	2 - Run signal
532	Operation mode OUT2D (X10/relay)	103 - Inv. error signal

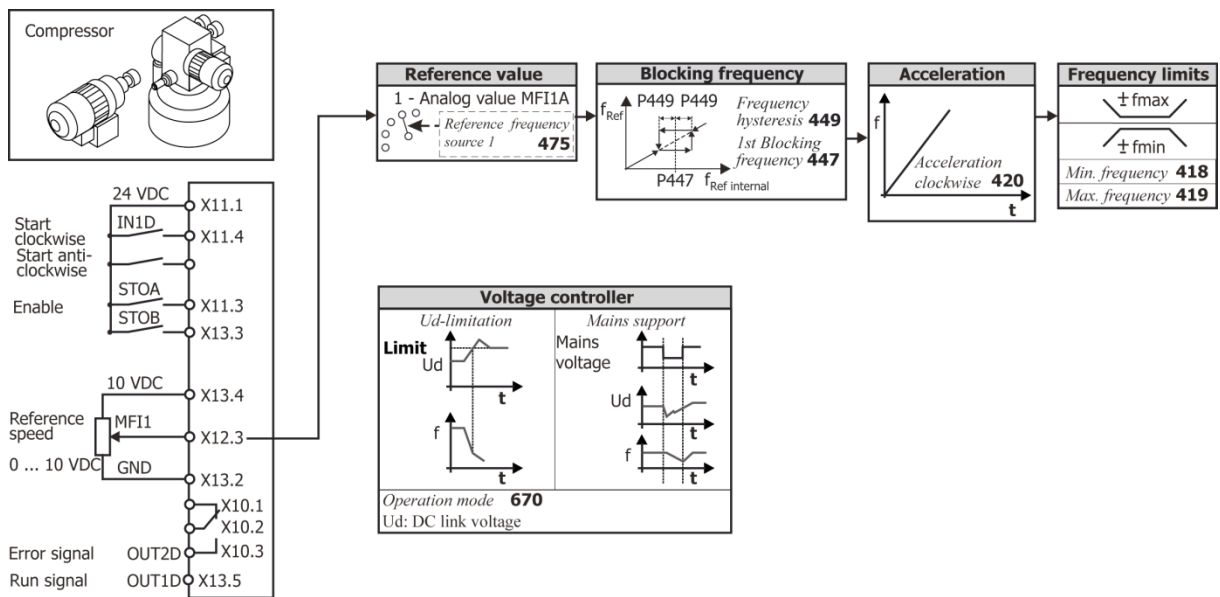

6.7.7 Travel applications

Parameters		Recommended setting
30	Configuration	110 IM: sensorless control (V/f characteristic)
418	Minimum frequency	10 Hz
419	Maximum frequency	50 Hz
420	Acceleration (clockwise)	15 Hz/s
421	Deceleration (clockwise)	15 Hz/s
475	Reference frequency source 1	1 - Analog Value MFI1A
480	Fixed frequency 1	10 Hz
481	Fixed frequency 2	25 Hz
482	Fixed frequency 3	40 Hz
483	Fixed frequency 4	50 Hz
492	Reference frequency source 2	3 - Fixed frequency
493	Operation mode (reference frequency source)	1 - (+/- reference)
558	Operation mode terminal X11.6 (digital input/output)	0 - Input IN3D
630	Operation mode (P68&P69=1 P68&P69=0) (stopping behaviour)	11 - (Stop, Off Stop, Off)
68	Start Clockwise	71 - IN1D
69	Start Anticlockwise	7 - Off
66	Fixed frequency Change-Over 1	73 - IN3D
67	Fixed frequency Change-Over 2	74 - IN4D
531	Operation mode OUT1D (X13.5) (digital output)	2 - Run signal
532	Operation mode OUT2D (X10/relay)	103 - Inv. error signal

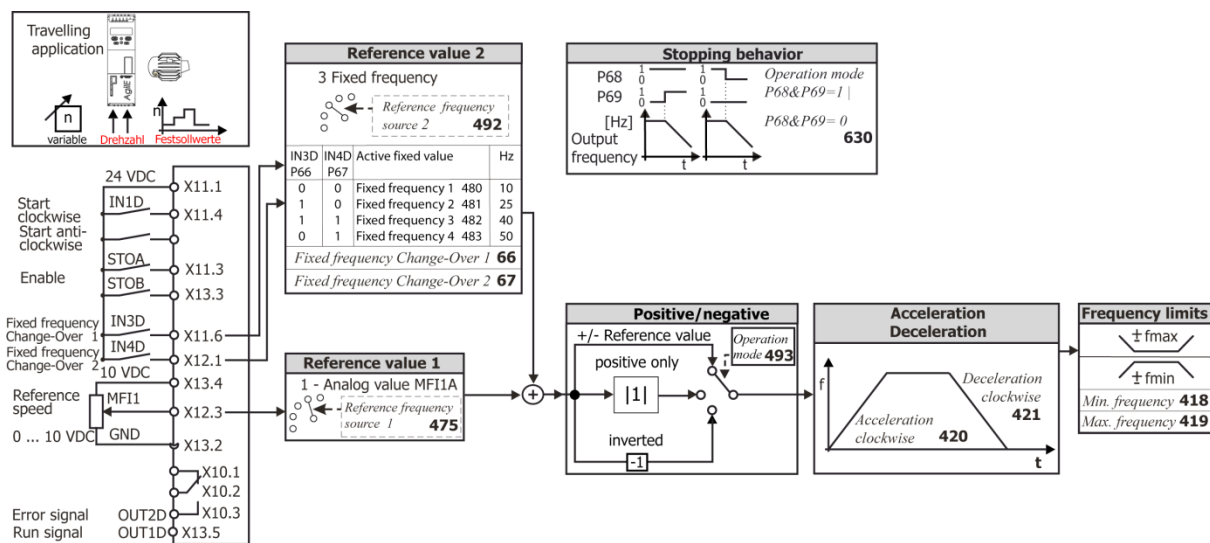

6.7.8 Torque control

The Torque control can be used in applications where a torque should be used as reference value instead of a frequency.

Via parameter *n/T Control Change-Over* **164** a jerk less switch over from Speed Control to Torque Control is possible.

100 % Torque refer to the calculated Torque from *Rated Mech. Power* **376** (Motor power) and *Rated Speed* **372** (Motor nominal speed).

The Torque control is only available in configurations 410 FOC and 610 SYNC.

Parameters		Recommended setting
164	n-/T-Control Change-Over	74 - IN4D
418	Minimum frequency	0 Hz ²⁾
419	Maximum frequency	53 Hz
420	Acceleration (clockwise)	5 Hz/s
421	Deceleration (clockwise)	-0.01 Hz ¹⁾
447	1st Blocking frequency	0 Hz
449	Frequency Hysteresis	0 Hz
475	Reference frequency source 1	1 - Analog Value MFI1A
476	Reference percentage source 1	2 - Analog Value MFI2A
477	Gradient percentage ramp	100%/s
492	Reference frequency source 2	0 – zero
493	Operation mode (reference frequency source)	1 - (+/- reference)
494	Reference percentage source 2	0 – zero
495	Operation mode (reference percentage source)	2 - positive only
518	Minimum reference percentage	0%
519	Maximum reference percentage	100%
520	Fixed percentage 1	0%
521	Fixed percentage 2	20%
562	Operation Mode MFI2 (Multifunction input 2)	1 - Voltage 0...10 V
630	Operation mode (P68&P69=1 P68&P69=0) (stopping behaviour)	0 - (Coast to Stop Coast to Stop)
651	Operation mode (auto start)	0 – Off
767	Frequency Upper limit	50 Hz
768	Frequency Lower limit	-50 Hz
66	Fixed frequency Change-Over 1	7 – Off
67	Fixed frequency Change-Over 2	7 – Off
68	Start Clockwise	71 - IN1D
69	Start Anticlockwise	7 – Off
70	Data set Change-Over 1	7 – Off
71	Data set Change-Over 2	7 – Off
75	Fixed percent Change-Over 1	7 – Off
76	Fixed percent Change-Over 2	7 – Off
531	Operation mode OUT1D (X13.5) (digital output)	2 - Run signal
532	Operation mode OUT2D (X10/relay)	103 - Inv. error signal

1) The setting -0.01 Hz effects the usage of the same ramp like stated in Parameters *Acceleration Clockwise* **420**.

1) KÜENLE ANTRIEBSSYSTEME recommends to set *Minimum frequency* **418** > *Frequency limit* **624**. Comply with the notes in chapter 7.9.5.2-“Torque controller”.

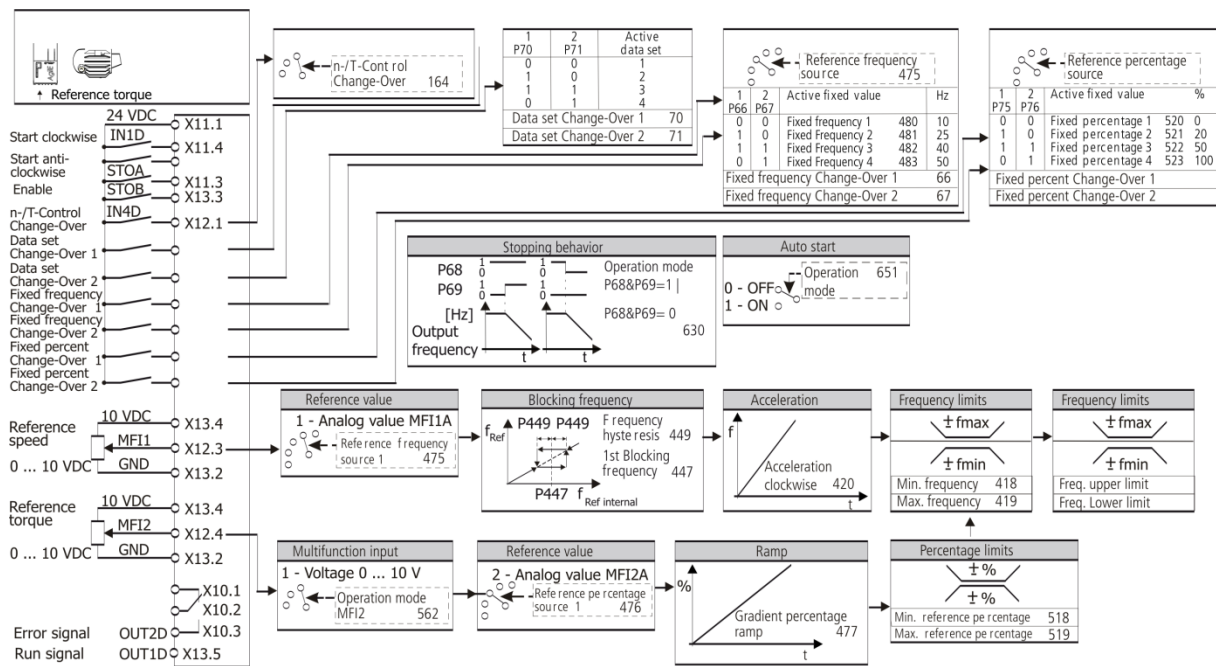

6.8 Set-up via the Communication Interface

796 SETUP Selection

Parameter-setting and commissioning of the frequency inverter via one of the communication interfaces include the plausibility check and the parameter identification functions. The parameter selection during the guided commissioning procedure includes the basic parameters. These are based on standard applications and support commissioning.

⚠ CAUTION



Parameter settings may only be changed by qualified staff. Before starting the commissioning process, read the documentation and comply with the safety instructions.

At the beginning of the auto set-up of a synchronous motor, the motor shaft will be aligned when enable is switched on. It must be ensured that, personal or material damage is excluded.

For parameter *SETUP Selection 796*, choose a function.

The function will be executed as soon as enable is switched on at digital inputs STOA and STOB.

The functions are also carried out automatically one after the other during the guided commissioning procedure.

SETUP Selection 796	Function
0 - Clear Status	The auto set-up routine does not perform a function.
1 - Continue	The warning message is acknowledged and the auto set-up routine is continued.
2 - Abort	The auto set-up routine is stopped and a RESET of the frequency inverter is performed.
10 - Complete Setup, DS0	The auto set-up routine is performed in data set 0 and the parameter values are stored in all of the four data sets identically (recommended).
11 - Complete Setup, DS1	The parameter values of the auto set-up are stored in data set 1.
12 - Complete Setup, DS2	The parameter values of the auto set-up are stored in data set 2.
13 - Complete Setup, DS3	The parameter values of the auto set-up are stored in data set 3.
14 - Complete Setup, DS4	The parameter values of the auto set-up are stored in data set 4.
20 - Plaus.-Check Machine Data, DS0	The auto set-up routine checks the rated motor parameters in the four data sets (plausibility check).

SETUP Selection 796	Function
21 - Plaus.-Check Machine Data, DS1	The rated motor parameters in data set 1 are checked for plausibility.
22 - Plaus.-Check Machine Data, DS2	The rated motor parameters in data set 2 are checked for plausibility.
23 - Plaus.-Check Machine Data, DS3	The rated motor parameters in data set 3 are checked for plausibility.
24 - Plaus.-Check Machine Data, DS4	The rated motor parameters in data set 4 are checked for plausibility.
30 - Calculation and Para-Ident., DS0	The auto set-up routine determines extended motor data via the parameter identification feature, calculates dependent parameters and stores the parameter values in all of the four data sets identically.
31 - Calculation and Para-Ident., DS1	Further motor data are measured, dependent parameters are calculated and the parameter values are saved in data set 1
32 - Calculation and Para-Ident., DS2	Further motor data are measured, dependent parameters are calculated and the parameter values are saved in data set 2
33 - Calculation and Para-Ident., DS3	Further motor data are measured, dependent parameters are calculated and the parameter values are saved in data set 3
34 - Calculation and Para-Ident., DS4	Further motor data are measured, dependent parameters are calculated and the parameter values are saved in data set 4
40 - Para-Ident. Machine Data only, DS0	Extended motor data are measured and saved identically in all data sets. Other parameter values already set are maintained.
41 - Para-Ident. Machine Data only, DS1	Extended motor data are measured and saved data set 1. Other parameter values already set are maintained.
42 - Para-Ident. Machine Data only, DS2	Extended motor data are measured and saved data set 2. Other parameter values already set are maintained.
43 - Para-Ident. Machine Data only, DS3	Extended motor data are measured and saved data set 3.
44 - Para-Ident. Machine Data only, DS4	Extended motor data are measured and saved data set 4. Other parameter values already set are maintained.

797 Setup Status

The individual steps of the auto set-up routine can be monitored and checked via parameter *SETUP Status 797*. The setup routine via the communication interface continuously updates the status parameter which can be read out via the interface.

Status messages	
Message	Meaning
OK	Auto set-up routine has been carried out.
PC Phase 1	The plausibility check of the motor data is active.
PC Phase 2	The calculation of dependent parameters is active.
STO	The parameter identification demands enable on digital input STOA and STOB.
Parameter identification	The rated motor values are checked by the parameter identification feature.
Setup already active	The setup routine via the operator panel is being carried out.
No Release	No enable signal. The parameter identification demands enable on digital input STOA and STOB.
Error	Error during the auto set-up routine.
Warning Phase Asymmetry	The parameter identification feature diagnosed an unbalance during the measurements in the three motor phases.
Setup not carried out	The setup is not carried out until now.

If a warning message is output or an error occurs during Setup, refer to chapter 6.2.5 "Warnings during commissioning (SA...)".

7 Parameter descriptions

This chapter contains the parameter descriptions. Please note, that some parameters are described more in detail in additional documentations. These are the parameters of the communication interfaces and the PLC function.

7.1 Inverter Data

Parameters can be set via the operator panel or the optional PC software VPlus (Version 6.0.1 or higher).

0 Serial Number

The *Serial Number 0* is entered on the type plate during the production of the frequency inverter. Information on the device type and the production data with 8-digit number are displayed. In addition, the serial number is printed on the rating plate.

Serial Number 0:

For example: 9120801234 (serial no.)

1 Optional modules

Modular extension of the hardware is possible via the plug-in slot. The communication module detected by the frequency inverter (Parameter *Optional module 1*) and the corresponding designations are displayed on the operator panel and in the optional control software VPlus after initialization. For the parameters which can be set for the communication module, refer to the corresponding operating instructions.

For example: CM-485

12 Inverter Software Version

The firmware stored in the frequency inverter defines the available parameters and functions of the software. The software version is indicated in parameter *Inverter Software Version 12*. In addition, the 9-digit software key is printed on the rating plate of the frequency inverter.

For example: *Inverter Software Version 12:* 6.1.4

On the rating plate: Version: 6.1.4; Software: 152 800 011

15 Copyright

(c) 2012 KÜENLE ANTRIEBSSYSTEME

16 Power Module Software Version

The power module of the frequency inverter features its own processor. The firmware of the power module is output via parameter *Power Module Software Version 16*.

29 User Name

The *User Name 29* can be entered via the optional control software VPlus. The name can be made up of 32 alphanumeric characters.

7.1.1 Control level

28 Control level

The *Control level 28* defines the scope of the functions to be parameterized. These operating instructions describe the parameters on the third control level. These parameters should only be set by qualified users.

Parameters		Setting		
No.	Identification	Min.	Max.	Fact. sett.
28	Control level	1	3	1

<i>Control level 28</i>		Selection on operator panel
1 - Parameters for quick commissioning.		Easy
2 - The parameters most used can be set.		Standard
3 - All parameters can be set.		Professional

7.1.2 Configuration

30 Configuration

The *Configuration 30* determines the control behaviour with which the electric motor is controlled. The operating instructions describe the following configurations and the relevant parameters in the third *Control level 28* (adjustment of parameter *Control level 28* to value 3).

CONFIGURATION 110, IM¹: SENSOR-LESS CONTROL

Configuration 110 contains the functions for variable-speed control of an asynchronous motor in a wide range of standard applications (e.g. for control of fans and pumps). The motor speed is set according to the V/f characteristic in accordance with the voltage/frequency ratio.

CONFIGURATION 410, IM: SENSOR-LESS FIELD-ORIENTATED CONTROL (DMC)²

Configuration 410 contains the functions for sensor-less, field-orientated control of an asynchronous motor. The current motor speed is determined from the present currents and voltages in combination with the motor parameters. Separate control of torque and flux-forming current enables high drive dynamism at a high load moment. In this configuration, parallel connection of several 3-phase motors is possible to a limited extent only.

CONFIGURATION 610, PMSM³: SENSOR-LESS FIELD-ORIENTATED CONTROL (DMC)

Configuration 610 contains the functions for sensor-less, field-orientated control of a synchronous motor. The current motor speed is determined from the present currents and voltages in combination with the motor parameters. Separate control of torque and flux-forming current enables high drive dynamism at a high load moment. This configuration is intended for the connection of a single motor. Parallel connection of several synchronous motors is not intended and possible to a very limited extent only.

¹ Asynchronous motor

² Direct moment control

³ Permanently excited synchronous motor.

Function	Chapter	Configuration		
		Asynchronous motor		Synchronous motor
		V/f characteristic	Field-orientated control	
		110	410	610
Speed control	7.9.5.3	x	x	x
Torque control	7.9.5.2		x	x
Switch-over speed/torque control	7.6.6.10		x	x
Dynamic voltage pre-control	7.8.1	x		
Intelligent current limits	7.9.1	x	x	x
Voltage controller	7.9.2	x	x	x
PID controller (technology controller)	7.9.3	x	x	x
Slip compensation	7.9.4.1	x		
Current limit value controller	7.9.4.2	x		
Current controller	7.9.5.1	x	x	x
Acceleration pre-control	7.9.5.4		x	x
Field controller	7.9.5.5		x	x
Modulation controller	7.9.5.5.1		x	x
Starting behaviour	7.3.2	x	x	x
Starting current impression	7.3.2	x	x	x
Flux-formation	7.3.2	x	x	x
Stopping behaviour	7.3.2	x	x	x
Direct current brake	7.3.6	x		
Auto start	7.3.4	x	x	x
Flying Start	7.3.5	x	x	x
Energy saving	8	x	x	x
Energy saving function (Flux reduction)	8	x	x	
Reference point positioning	7.3.7	x	x	x
PLC function	7.6.6.16	x	x	x
Frequency reference channel	7.5.1	x	x	x
Reference percentage channel	7.5.2	x	x	x
Fixed frequencies	7.5.1.3	x	x	x
Fixed percentages	7.5.2	x	x	x
Blocking frequencies	7.5.1.5	x	x	x
Input PWM/repetition frequency/pulse train	7.5.4	x	x	x
Brake chopper	7.10.4	x	x	x
Motor circuit breaker	7.10.6	x	x	x
V-belt monitoring	7.10.7	x	x	x
Motor chopper	7.10.5		x	x
Real-time tuning	7.9.6		x	x

7.1.3 Set password

27 Set password

As a protection against unauthorized access, the parameter *Set password* **27** can be set such that anyone who wants to change parameters must enter this password before. A change of parameter is only possible if the password is entered correctly. If the *Set password* **27** parameter is set to zero, no password is required for access to the parameters. The previous password is deleted.

Parameters		Setting		
No.	Identification	Min.	Max.	Fact. sett.
27	Set password	0	999	0

If a password is set the password entry is necessary for

- modification of parameter values
- start of Setup
- upload of parameter values from memory card to frequency inverter

The correct entered password unlocks all functions for 10 minutes. After 10 minutes the password protection is switched on again automatically.

The modification of a password is possible in control level 3 (parameter *Control level* **28**).

The control facilities of the operator panel are not locked. For the restriction of control facilities refer to chapter 7.5.1 "Reference frequency channel", 7.5.2 "Reference percentage channel" and 7.3 "Operational Behaviour".

7.1.4 Programming

34 Program(ming)

The parameter *Program(ming)* **34** enables acknowledgment of a fault message and resetting to the factory settings.

<i>Program(ming)</i> 34	Function
123 - Reset	A hardware reset is done (Behaviour like Mains-Off/Mains-On).
4444 - Default	The parameters of the selected configuration, except for a few exceptions, are reset to the default settings. The display of the control unit reads "dEFLt".



Parameters *Control level* **28** and *Configuration* **30** are not changed during resetting to factory settings (*Program(ing)* **34** = 4444).



With Keypad Parameter default settings:

Select P34 in Menu Para. Press both arrow keys to jump to value 4443. Set P34 to 4444 and confirm with ENT. This sets all parameters to the default values.

7.2 Machine data

The input of the machine data is the foundation for the functionality of the control functions and methods. You will have to enter the motor ratings during the guided commissioning (setup).

7.2.1 Rated motor parameters

370 Rated voltage

371 Rated current

372 Rated speed

373 No. of pole pairs

374 Rated cosine Phi

375 Rated frequency

376 Rated mechanical power

Parameterize the rated motor data according to the rating plate of the motor of the motor data sheet. The default settings of the machine parameters are based on the nominal data of the frequency inverter and a four-pole asynchronous motor. The machine data required for the control functions and methods are checked for plausibility and calculated in the course of the commissioning.



Parameter *Rated cosine Phi* **374** is not available in configuration 610 (synchronous motors).

Parameters		Setting		
No.	Description	Min.	Max.	Fact. sett.
370	Rated voltage	$0.17 \cdot U_{FIN}$	$2 \cdot U_{FIN}$	U_{FIN}
371	Rated current	$0.01 \cdot I_{FIN}$	$10 \cdot \alpha_c \cdot I_{FIN}$	I_{FIN}
372	Rated speed	30 min^{-1}	60000 min^{-1}	n_N
373	No. of pole pairs	1	24	2
374	Rated cosine Phi	0.01	1.00	$\cos(\varphi)_N$
375	Rated frequency	10.00 Hz	1000.00 Hz	50.00 Hz
376	Rated mechanical power	$0.01 \cdot P_{FIN}$	$10 \cdot P_{FIN}$	P_{FIN}

U_{FIN} = Nominal Frequency inverter voltage, usually 400 V or 230 V

I_{FIN} = Nominal Frequency inverter output current

P_{FIN} = Nominal Frequency inverter power

α_c : Overload capacity of frequency inverter.

In the case of asynchronous machines, the speed can be increased at a constant torque if the motor winding can be switched over from star to delta connection. The changeover leads to a modification of the dependent rated figures by a square root of three.

NOTICE

The rated data of the motor are to be entered according to the specifications on the rating plate for the motor connection type used (star or delta connection). If the data entered deviate from the rating plate, the parameters will not be identified correctly. Parameterize the rated data according to the rating plate of the motor for the wiring of the motor winding. Consider the increased rated current of the connected asynchronous motor.

Input via operator panel

- The motor ratings must be entered when the "Setup" menu is selected on the operator panel.
- The motor ratings can be entered in menu "Para" for parameters 370 ... 376.

7.2.2 Further motor parameters

In particular the field-orientated control requires the determination of further data which cannot be read off the rating plate of the asynchronous or synchronous motor for the precise calculation of the machine model. In the course of the guided commissioning (setup), the parameter identification is carried out to measure the further motor parameters.

The values of the following parameters will not be measured by the frequency inverter during the guided commissioning (setup). Changing the measured values is normally not required.

<i>Configuration 30</i> = 110 Asynchronous motor	<i>Configuration 30</i> = 410 Asynchronous motor
<i>Stator resistance 377</i>	<i>Rated voltage correction factor 368</i>
<i>Leakage coefficient 378</i>	<i>Stator resistance 377</i>
	<i>Leakage coefficient 378</i>
	<i>Rated magnetising current 716</i>
	<i>Rated slip correction factor 718</i>

<i>Configuration 30</i> = 610 Synchronous motor
<i>Stator resistance 1190</i>
<i>Voltage constant 383</i> , if no input before
<i>Stator inductance 384</i>

377 Stator resistance (asynchronous motor)

1190 Stator resistance (synchronous motor)

The resistance of the stator winding is measured during the guided commissioning. The measured value is saved as a phase value in parameter *Stator resistance 377* and is 3 times smaller than the winding resistance in delta connection.

By default, the stator resistance of a standard motor is entered to match the reference output of the frequency inverter.

Parameters		Setting		
No.	Description	Min.	Max.	Fact. sett.
377	Stator resistance ¹⁾	0 mΩ	65535 mΩ	R _{sN}
1190	Stator resistance ²⁾	0.001 Ω	100.000 Ω	10.000 Ω

¹⁾ In settings 110 and 410 of parameter *Configuration 30*.

²⁾ In setting 610 of parameter *Configuration 30*.

STATOR RESISTANCE ASYNCHRONOUS MOTOR:

For sensorless control according to V/f characteristic (setting 110 for *Configuration 30*): The stator resistance of an asynchronous motor can be optimized while the machine is in no-load operation. At the stationary operating point, the torque-forming current *I_{sq} 216* and/or the estimated *Active current 214* should be zero. Due to the temperature-dependent of the stator resistance, the adjustment should be done at a winding temperature which is also reached during normal operation.

A correct measurement will optimize the control functions.

For sensorless field-orientated control according to V/f characteristic (setting 410 for *Configuration 30*): The stator resistance value determined during the guided commissioning procedure is suitable for most applications and does not have to be optimized.

STATOR RESISTANCE SYNCHRONOUS MOTOR:

The stator resistance value of a synchronous motor is entered during commissioning. The stator resistance is needed particular of operation at low speeds and should be available and entered as exactly as possible for this reason. The *Stator resistance 1190* refers to the quantity between two motor phases and can typically be taken from the data sheet of the motor.

The stator resistance value determined during the guided commissioning procedure is suitable for most applications and does not have to be optimized.

378 Leakage Coefficient (asynchronous motor)

The leakage coefficient of the motor defines the ratio of the leakage inductivity to the main inductivity. The torque and flux-forming current components are thus coupled via the leakage coefficient. Optimization of the leakage coefficient within the field-orientated control systems demands acceleration to various operating points of the drive. Unlike the torque-forming current I_{sq} **216**, the flow-forming current I_{sd} **215** should be largely independent of the load torque. The flow-forming current component is inversely proportional to the leakage coefficient. If the leakage coefficient is increased, the torque-forming current increases and the flux-forming component drops. The adjustment should result in a relatively constant actual current I_{sd} **215**, matching the set *Rated magnetizing current* **716**, regardless of the load on the drive.

The sensor-less control system uses the parameter *Leakage Coefficient* **378** in order to optimize the synchronization to one drive.

Parameters		Setting		
No.	Description	Min.	Max.	Fact. sett.
378	Leakage Coefficient	1.0%	20.0%	7.0%

716 Rated magnetising current (asynchronous motor, field-orientated control)

The *Rated magnetising current* **716** is a measure for the current in the motor. The motor voltage will build up accordingly in no-load operation (depending on speed). The guided commissioning determines this value at approx. 30% to 50% of the *Rated current* **371**. This current can be compared to the field current of an externally excited direct current machine.

Parameters		Setting		
No.	Description	Min.	Max.	Fact. sett.
716	Rated magnetising current	$0.01 \cdot I_{FIN}$	$0_c \cdot I_{FIN}$	$0.3 \cdot I_{FIN}$

I_{FIN} : Nominal value of frequency inverter

0_c : Overload capacity of frequency inverter

The rated magnetizing current determined during the guided commissioning procedure is set to an optimized value and does not have to be adjusted.

718 Rated slip correction factor (asynchronous motor, field-orientated control)

The rotor time constant results from the inductivity of the rotor circuit and the rotor resistance. Due to the temperature-dependence of the rotor resistance and the saturation effects of the iron, the rotor time constant is also dependent on temperature and current. The load behaviour and thus the rated slip depend on the rotor time constant. The guided commissioning determines the machine data during the parameter identification and sets the parameter *Rated slip correction factor* **718** accordingly. The value calculated by the rotor time constants can be read out via the actual value *Current rotor time constant* **227**. Parameter identification (during guided commissioning "Setup") should be done while the motor is cold.

Parameters		Setting		
No.	Description	Min.	Max.	Fact. sett.
718	Rated slip correction factor	0.01%	300.00%	100.00%

383 Voltage constant (synchronous motor)

In Configuration 610 (parameter *Configuration* **30**) for control of synchronous motors, the control behaviour should be optimized by setting parameter *Voltage constant* **383**.

The auto-setup during the guided commissioning (setup) identifies the voltage constant of the synchronous motor. If a value > 0 mV was entered before manually, the voltage constant will not be determined during auto-setup. The entered value is maintained.

For the voltage constant, refer to the motor data sheet. In the motor data sheet, the value may be indicated in $\frac{V}{1000 \frac{U}{\text{min}}}$. This value can be taken over for Parameter *Voltage constant* **383**.

Parameters		Setting		
No.	Description	Min.	Max.	Fact. sett.
383	Voltage constant	0.0 mVmin	6500.0 mVmin	0.0 mVmin

If the guided commissioning (Setup) is not carried out, the auto-setup should be carried out via parameter *SETUP selection* **796** in order to improve the drive behaviour, particularly for small speeds. Select one of the settings 10 ... 14 for *SETUP selection* **796**.

During the guided commissioning (via keypad and VPlus) for KÜENLE motors the voltage constant is pre-allocated.

For Non-KÜENLE motors the voltage constant should be entered if it is known. If the voltage constant is unknown, set *Voltage constant* **383** to 0 mV before the commissioning to ensure the automatic calculation and measurement.

The voltage constant should be optimized after the guided commissioning procedure: In no-load operation, set 50% of the rated speed. Change the voltage constant in small steps until parameter *Rotor flux* **225** displays the value 101% ($\pm 0.5\%$).



In the case of motors with a very high number of pole pairs (e.g. higher than 20), it is possible that the maximum setting range of the parameter is not sufficient. In this case, divide the voltage constant by 10 and enter the value. The division by 10 is considered internally.

384 Stator inductance (synchronous motor)

In configuration 610 for the control of synchronous machines, the control behaviour can be improved for high dynamic requirements by setting the parameter *Stator inductance* **384**.

The value of parameter *Stator inductance* **384** refers to the quantity between two motor phases and can typically be taken from the data sheet of the motor.

Parameters		Setting		
No.	Description	Min.	Max.	Fact. sett.
384	Stator inductance	0.1 mH	500.0 mH	1.0 mH

1192 Peak current (synchronous motor)

The parameter *Peak current* **1192** is used during commissioning of the motor to set the limit for the reference Isq value in the frequency inverter. This is to protect the connected synchronous motor. The value can be taken from the motor rating plate or the motor data sheet. Exceeding the value specified by the manufacturer may result in motor damage.

Parameters		Setting		
No.	Description	Min.	Max.	Fact. sett.
1192	Peak current	0.01% I _{FIN}	100000% o _c ·I _{FIN}	100% I _{FIN}

I_{FIN}: Nominal value of frequency inverter

o_c: Overload capacity of frequency inverter.

7.2.3 Device test

For easier troubleshooting in the device or in a plant, the internal and externally connected hardware can be tested. Errors in the frequency inverter, external sensors, the load (motor) and electrical connections will be identified.

In order to be able to test individual components separately, the device test is split up in individual tests which can be activated separately.

7.2.3.1 Earth fault and short circuit test (Test 1)

 **WARNING**



Synchronous motors may move briefly while the test is performed. It must be checked if there is a potential risk of personal injury or material damage. If necessary, access to hazard areas must be safely prevented.

If a synchronous motor is connected: The test must not be started while the synchronous motor runs.

Test 1 checks if there is an earth fault or a short-circuit against DC-link potential in the load (motor) or in the frequency inverter. This test can be carried out with or without load.

In this test, all six IGBTs (transistors) will be switched on briefly individually. No current may flow in this process even if the load is connected.

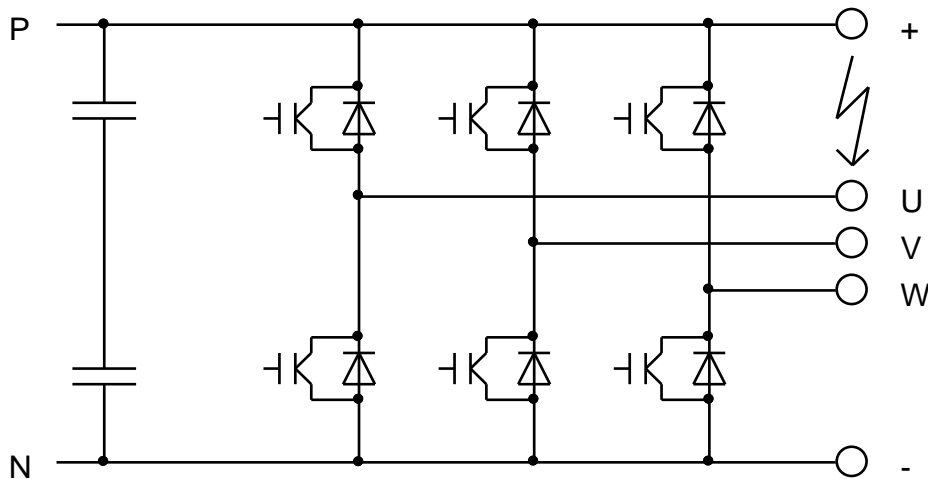

If, for example, there is a short-circuit between the positive DC-link potential (P or +) and branch U (see illustration), the test would be stopped and error "T0104 earth /P-U fault" would be displayed. This may either be a "hard" short-circuit or a "soft" short-circuit, i.e. a short-circuit with a relatively high resistance. Short-circuits which don't trigger a hardware overcurrent circuit breaker, but cause a current which is 10 % greater than the rated current peak value are signalled as earth faults.

If an error is signalled during a test with connected load, the test should be repeated without connected load, in order to find out if the device or the load is defective.

If an error is only signalled while the load is connected, it is an earth fault in the load or - if the DC-link terminals are assigned - possibly a short-circuit between a load branch and a DC-link potential.

If an error is also signalled while the load terminals are not assigned, there is a short-circuit in the device or an IGBT is defective. In the case of a defective IGBT or a short-circuit in the device, the error will be signalled in several branches while the load is connected, as the current can also flow via the load. In this case, only the messages generated while the load is not connected may be considered.

Non-switching IGBTs or non-functioning current measurements will not be detected by this test (but by Test 2). In this case existing errors which would normally be identified by this test might not be detected.

Message	Meaning
T0001	Stop. Test stopped by user.
T0002	Permanent error. Non-acknowledgeable error present. No (further) test possible.
T0003	Signals on digital inputs STOA and STOB for enable missing. No enable.
T0010	At the beginning of the test an inadmissible current flows.

Message	Meaning
T0101	Earth /N-U fault. Short-circuit between branch U and the negative DC-link potential or PE.
T0102	Earth /N-V fault. Short-circuit between branch V and the negative DC-link potential or PE.
T0103	Earth /N-W fault. Short-circuit between branch W and the negative DC-link potential or PE.
T0104	Earth /P-U fault. Short-circuit between branch U and the positive DC-link potential or PE.
T0105	Earth /P-V fault. Short-circuit between branch V and the positive DC-link potential or PE.
T0106	Earth /P-W fault. Short-circuit between branch W and the positive DC-link potential or PE.
T0114	Soft earth /P-U fault. Short-circuit between branch U and the positive DC-link potential or PE.
T0115	Soft earth /P-V fault. Short-circuit between branch V and the positive DC-link potential or PE.
T0116	Soft earth /P-W fault. Short-circuit between branch W and the positive DC-link potential or PE.
Err.S41	Internal error. Abort and restart the test.

The Parameter *Status Device test* **1541** shows the state of the device test and messages that are created during the test.

7.2.3.2 Load test (Test 2)



⚠ WARNING

If a synchronous motor is connected: The test must not be started while the synchronous motor runs.

Synchronous motors may move briefly while the test is performed. It must be checked if there is a potential risk of personal injury or material damage. If necessary, access to hazard areas must be safely prevented.

Test 2 checks if a direct current can be impressed in the connected load (motor) in both directions. Test 1 should be carried out before without any error messages.

For Test 2, a three-phase choke or a three-phase motor must be connected as the load. The load may be star or delta connected. The star point must not be connected, if applicable.

Test 2 impresses a positive and a negative direct current in each branch one after the other. If no current can be impressed in any direction, an error will be signalled. IGBTs, the load and the current measurement are checked.

If an error is signalled in a branch both for positive and negative current, the relevant load branch circuit is open (e.g. broken wire) or the relevant current measurement is defective. If an error is signalled in a branch for one polarity only, an IGBT or driver is defective or a connection in the device is interrupted.

The impressed direct current is 25% of the peak value of the rated current. The rated current must be set with parameter *Rated Current* **371** in data set 1.

In order to prevent damage of the device and the load, the output voltage is limited. If the set current (see above) cannot be reached with this voltage due to a high ohmic resistance of the load, an open-circuit error is identified in each branch. In this case, the current to be impressed must be reduced by changing parameter *Rated Current* **371**.

Message	Meaning
T0001	Stop. Test stopped by user.
T0002	Permanent error. Non-acknowledgeable error present. No (further) test possible.
T0003	Signals on digital inputs STOA and STOB for enable missing. No enable.
T0010	At the beginning of the test an inadmissible current flows.
T0201	U open. It was not possible to impress a positive current in branch U.
T0202	V open. It was not possible to impress a positive current in branch V.
T0203	W open. It was not possible to impress a positive current in branch W.
T0204	-U open. It was not possible to impress a negative current in branch U.

Message	Meaning
T0205	-V open. It was not possible to impress a negative current in branch V.
T0206	-W open. It was not possible to impress a negative current in branch W.
T0211	U short-circuit. Short-circuit cutoff during impression of positive current in branch U.
T0212	V short-circuit. Short-circuit cutoff during impression of positive current in branch V.
T0213	W short-circuit. Short-circuit cutoff during impression of positive current in branch W.
T0214	-U short-circuit. Short-circuit cutoff during impression of negative current in branch U.
T0215	-V short-circuit. Short-circuit cutoff during impression of negative current in branch V.
T0216	-W short-circuit. Short-circuit cutoff during impression of negative current in branch W.
T0221	Earth fault Phase U. Earth fault cutoff during impression of positive current in branch U.
T0222	Earth fault Phase V. Earth fault cutoff during impression of positive current in branch V.
T0223	Earth fault Phase W. Earth fault cutoff during impression of pos. current in branch W.
T0224	-U earth fault. Earth fault cutoff during impression of negative current in branch U.
T0225	-V earth fault. Earth fault cutoff during impression of negative current in branch V.
T0226	-W earth fault. Earth fault cutoff during impression of negative current in branch W.
T0231	U Soft earth fault. The DC-link voltage has increased. Insulation problem in motor.
T0232	V Soft earth fault. The DC-link voltage has increased. Insulation problem in motor.
T0233	W Soft earth fault. The DC-link voltage has increased. Insulation problem in motor.
T0234	-U Soft earth fault Phase U. Insulation problem in motor.
T0235	-V Soft earth fault Phase V. Insulation problem in motor.
T0236	-W Soft earth fault Phase W. Insulation problem in motor.
T0260	Asymmetric phase voltages.
Err.S41	Internal error. Abort and restart the test.

If Test 2 signals an earth fault while Test 1 did not signal an earth fault, a current measurement will probably be defective.

If Test 2 signals a short-circuit, there is either a short-circuit in the load or a current measurement is defective.

The Parameter *Status Device test* **1541** shows the state of the device test and messages that are created during the test.

7.2.3.3 Start device test via operator panel

The device test can be started via the operator panel.

- Switch on enable at inputs STOA and STOB.
- Select menu item "Test" in "Local" menu.
- Select Test 1 or Test 2. It is recommended that you start with Test 1.
- Press "ENT" button to start Test 1.

If Test 1 is finished and no error was detected, "t1 good" will be displayed.

- Confirm by pressing the "ENT" button. Menu item "Test 2" will be displayed.
- Press "ENT" button to start Test 2.

If Test 2 is finished and no error was detected, "t2 good" will be displayed.

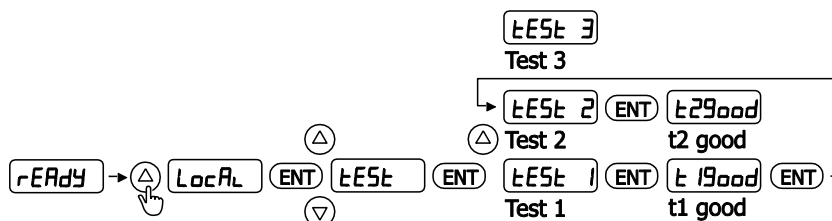

Test 3: Refer to chapter 7.2.3.6 "Fan test".

If an error was detected and a message was displayed, the relevant error must be repaired following the instructions in chapters 7.2.3.1 "Earth fault and short circuit test (Test 1)" or 7.2.3.2 "Load test (Test 2)".

Parameter *Status device test* **1541** indicates the status of the device test and messages generated during the test.

After a message, the test can be continued by pressing "ENT".

Press "ESC" to stop the test. In this case, message "tEst" is displayed.



If "STO" is displayed if the device test is to be started, enable must be switched on at inputs STOA and STOB.

7.2.3.4 Start device test via control software or bus system

1540 Start device test manual

The device test can be started via the control software VPlus or a connected bus system

Start device test manual 1540	Function
0 - Clear status	Deletes the messages generated during the test. Factory setting.
1 - Continue	Continues the current test after a message.
2 - Cancel	Stops the current test.
11 - Start Test 1	Starts Test 1 (earth fault and short-circuit test).
12 - Start Test 2	Starts Test 2 (load test).
13 - Start Test 1 and Test 2	Starts Test 1 (earth fault and short-circuit test) and Test 2 (load test).



Enable at inputs STOA and STOB must be switched on in order to be able to carry out the test.

Parameter *Status device test* **1541** indicates the status of the device test and messages generated during the test.

7.2.3.5 Automatic device test after error switch-off

1542 Start device test automatic

The device test can be started automatically after each error switch-off of the frequency inverter. The device test will start once the frequency inverter is restarted after an error switch-off.

Start device test automatic 1542	Function
0 - Off	No automatic device test after error switch-off. Factory setting.
1 - Start Test 1	Test 1 (earth fault and short-circuit test) will start automatically after an error switch-off of the frequency inverter followed by a start command.
2 - Start Test 2	Test 2 (load test) will start automatically after an error switch-off of the frequency inverter followed by a start command.
3 - Start Test 1 and Test 2	Test 1 (earth fault and short-circuit test) and Test 2 (load test) will start automatically after an error switch-off of the frequency inverter followed by a start command.

NOTICE

The automatic device test may result in a delayed start of the motor after a start command.

Parameter *Status Device Test* **1541** indicates the status of the device test and messages generated during the test.

The device test will possibly start some time after the frequency inverter is switched on because the test must not be carried out with the motor magnetized.

7.2.3.6 Fan test

The function of the interior fan and heat sink fan is tested. Dependent on the type of the frequency inverter, fans are possibly not installed (refer to chapter 11.2 "Device data").

The device test can be started via the operator panel.

- Switch on enable at inputs STOA and STOB.
- Select menu item "Test" in "Local" menu.
- Select Test 3.
- Press "ENT" button to start Test 3.

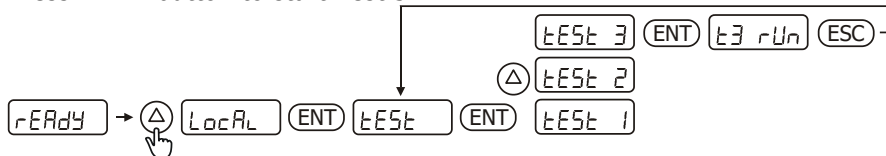

The interior fan and heat sink fan must rotate.
Press "ESC" button to finish the test.



If "STO" is displayed if the fan test is to be started, enable must be switched on at inputs STOA and STOB.

Check for unusual operating noise and remove any soiling and dust if necessary.
If a fan does not rotate contact the service of KÜENLE.

7.3 Operational Behaviour

The operational behaviour of the frequency inverter can be adjusted to the application by setting the parameters appropriately. In particular the acceleration and deceleration behaviour can be selected according to the selected *Configuration 30*. Additionally, features such as Auto Start, and the synchronization and positioning functions facilitate the integration in the application.

7.3.1 Control

The frequency inverters are suitable for data communication and can be extended by communication modules. In this way, they can be integrated in an automation and control system. Parameterization and commissioning can be done via the operator panel or a communication interface.

Control can be done via contacts, keypad on the operator panel or communication interface.

412 Local/Remote

Parameter *Local/Remote 412* defines the command sources for start, stop and direction of rotation are to be issued. The parameter enables choosing from control via contacts, operator panel or communication interface.

Local/Remote 412	Function
0 - Control via Contacts	The commands start and stop as well as the definition of the direction of rotation (parameters <i>Start Clockwise</i> 68 , <i>Start Anticlockwise</i> 69) are issued via digital inputs. Run, Stop and Reset commands from the keypad keys are ignored.
1 - Control via Statemachine	The Start and Stop commands as well as the direction of rotation are controlled via the Remote Statemachine of the communication interface. The control is done via the Controlword, which can be monitored via 410 <i>Controlword</i> or which can be used to simulate it. With 411 <i>Statusword</i> the state of the drive can be monitored. The statusword is typically sent to the overlying control (PLC). Run, Stop and Reset commands from the keypad keys are ignored.
2 - Control via Remote-Contacts	The Start and Stop commands as well as the direction of rotation are controlled via logic signals through the communication protocol. Run, Stop and Reset commands from the keypad keys are ignored.
3 - Control via Keypad	The start and stop commands as well as the direction of rotation are entered via the operator panel.
4 - Control via Keypad or Cont.	The start and stop commands as well as the direction of rotation are entered via the operator panel or via digital inputs. Factory setting.
5 - Control 3-Wire	Control of direction of rotation (parameters <i>Start Clockwise</i> 68 , <i>Start Anticlockwise</i> 69) and signal <i>Start 3-wire control</i> 87 via digital inputs.

 **WARNING**



If the operation mode is changed while the drive is running, the drive will not be stopped if no stop command is present in the new operation mode.

In order to be able to control the drive, the output stage must be enabled by digital inputs STOA and STOB.



Signals via physical contacts (IN1D...IN5D, MFI1, MFI2) are only evaluated if an operation mode with "Control via Contact" or "Control 3-Wire" (0, 4 or 5) is selected.

In all other operation modes (1, 2, 3) physical contacts are only evaluated, if the corresponding signals in the digital inputs with the suffix (Hardware) are selected. Please comply with chapter 7.6.6 "Digital inputs".

Signals not referring to a physical input are evaluated independent of the operation mode *Local/Remote* **412**.

Lock the Reference value facilities of the control panel

If the setting possibility of the reference frequency at the operator panel must be locked: For the following parameters the setting "5 - Keypad-Motorpot." must not be selected.

- *Reference Frequency Source 1* **475**, *Reference Frequency Source 2* **492**
- *Reference Percentage Source 1* **476**, *Reference Percentage Source 2* **494**

Set parameter *Set Password* **27** to prevent the resetting of parameters. Refer to chapter 7.1.3 "Set password".

NOTICE

The setting of parameter *Set Password* **27** only does not lock the control facilities of the keypad. Start, Stop, Change direction of rotation, Poti F and Poti P are still available.

7.3.2 Starting behaviour

The starting behaviour of the machine can be configured. In Configuration 110 (V/f control of asynchronous motor) the starting behaviour can be set via parameter *Operation mode* **620**.

In the field-orientated control method of configurations 410 (asynchronous motor) and 610 (synchronous motor), the starting behaviour can be set via the limits *Maximum flux-formation time* **780** and *Current during flux-formation* **781**.

Parameter of starting behaviour in the configurations

	U/f	DMR Asynchronous motor	DMR Synchronous motor
<i>Configuration</i> 30	110	410	610
620	x		
621	x		
622	x		
623	x	x	x
624	x	x	x
625	x	x	x
779		x	x
780	x	x	x
781	x	x	x

620 Operation mode (starting behaviour)

The parameter *Operation mode* **620** for the starting behaviour is available if *Configuration* **30** = "110 - IM: sensorless control" (V/f control of asynchronous motor) is selected. Depending on the operation mode selected, the motor is magnetized first or a starting current is impressed. The voltage drop across the stator resistance which reduces the torque in the lower frequency range can be compensated by the IxR compensation.

To ensure the correct function of the IxR compensation, the stator resistance is determined during the guided commissioning (Setup). The IxR compensation is only activated when the stator resistance was determined correctly.

<i>Operation mode</i> 620	Starting behaviour
0 - Off	During startup, at an output frequency of 0 Hz, the voltage is set via parameter <i>Starting voltage</i> 600 . After this, the output voltage and the output frequency are changed according to the control method. The break-away torque and the current at the start are determined by the adjusted starting voltage. It may be necessary to optimize the starting behaviour via the parameter <i>Starting voltage</i> 600 .
1 - Magnetisation	In this operation mode, the <i>Current during flux-formation</i> 781 for magnetization is impressed into the motor after enable. The output frequency is kept at zero Hz not exceeding the <i>Maximum flux-formation time</i> 780 . After this time has expired (at the latest), the output frequency follows the adjusted V/f characteristic.
2 - Magnetisation + current impression	Operation mode 2 includes operation mode 1. After the <i>Maximum flux-formation time</i> 780 has elapsed (at the latest), the output frequency is increased according to the set acceleration and the starting current is impressed. If the output frequency reaches the value set with the parameter <i>Frequency limit</i> 624 , the <i>Starting current</i> 623 is withdrawn. There is a smooth transition to 1.4 times the frequency limit to the set V/f characteristic. As from this operating point, the output current depends on the load. Factory setting.

Operation mode 620	Starting behaviour
3 - Magnetisation + IxR-compensation	Operation mode 3 includes operation mode 1. When the output frequency reaches the value set with parameter <i>Frequency limit</i> 624 , the increase of the output voltage by the IxR compensation becomes effective. The V/f characteristic is displaced by the portion of voltage which depends on the stator resistance.
4 - Magnetisation + current impression + IxR-compensation	In this operation mode, the current set with the parameter <i>Current during flux-formation</i> 781 is impressed into the motor for magnetization after enable. The output frequency is kept at zero Hz not exceeding the <i>Maximum flux-formation time</i> 780 . After the time has elapsed (at the latest), the output frequency is increased according to the set acceleration and the starting current is impressed. If the output frequency reaches the value set with the parameter <i>Frequency limit</i> 624 , the <i>Starting current</i> 623 is withdrawn. There is a smooth transition to the V/f characteristic, and a load-dependent output current is obtained. At the same time, the increase of the output voltage by the IxR compensation becomes effective as from this output frequency. The V/f characteristic is displaced by the portion of voltage which depends on the stator resistance.
12 - Magnetisation + current impression with ramp stop	Operation mode 12 contains an additional function to guarantee a starting behaviour under difficult conditions. The magnetization and starting current impression are done according to operation mode 2. The ramp stop takes the current consumption of the motor at the corresponding operating point into account and controls the frequency and voltage change by stopping the ramp. The <i>Controller status</i> 275 signals the intervention of the controller by displaying the message "RSTP".
14 - Magnetisation + current impression with ramp stop + IxR-compensation	In this operation mode, the functions of operation mode 12 are extended by the compensation of the volt-age drop across the stator resistance. When the output frequency reaches the value set with parameter <i>Frequency limit</i> 624 , the increase of the output voltage by the IxR compensation becomes effective. The V/f characteristic is displaced by the portion of voltage which depends on the stator resistance.

621 Amplification

622 Integral time

In setting *Configuration* **30** = "110 - IM: sensorless control" (V/f control of asynchronous motor), a current controller is available for the starting behaviour. The PI controller controls the current impression via parameter *Starting current* **623**. The proportional and integrating part of the current controller can be set via parameters *Amplification* **621** and *Integral time* **622**.

Parameters		Setting		
No.	Description	Min.	Max.	Fact. sett.
621	Amplification	0.01	10.00	2.00
622	Integral time	1 ms	30000 ms	50 ms

623 Starting current

The *Starting current* **623** ensures, particularly for high-torque start, a sufficient torque until the *Frequency limit* **624** is reached.

Applications in which high current is permanently needed at a low speed are to be realized using forced-ventilated motors to prevent thermal overload.

Parameters		Setting		
No.	Description	Min.	Max.	Fact. sett.
623	Starting current	0.0 A	o _c ·I _{FIN}	I _{FIN}

I_{FIN}: Nominal value of frequency inverter

o_c: Overload capacity of frequency inverter.

In the following settings, the starting current impression is used for the starting behaviour:

- *Configuration 30* = "110 - IM: sensor-less control" (V/f control of asynchronous motor), *Operation mode 620* =2, 4, 12 or 14
- *Configuration 30*= "410 - IM: sensor-less field-orientated control (DMC)", asynchronous motor
- *Configuration 30*= "610 - PMSM: sensor-less field-orientated control (DMC)", synchronous motor

624 Frequency limit

The *Starting current 623* is impressed until the *Frequency limit 624* is reached. Permanent operating points below the frequency limit are only permissible if forced-ventilated motors are used.

The transition to the control method of the selected *Configuration 30* takes place above the frequency limit.

The *Frequency limit 624* is set up automatically during the guided motor commissioning in field oriented control configurations 410 and 610. In V/f control configuration 110 the parameter *Frequency limit 624* is not changed by the guided motor commissioning.

Parameters		Setting		
No.	Description	Min.	Max.	Fact. sett.
624	Frequency Limit	0.00 Hz	100.00 Hz	2.60 Hz

In the following settings, the starting current impression is used for the starting behaviour:

- *Configuration 30* = "110 - IM: sensor-less control" (V/f characteristic of asynchronous motor), *Operation mode 620* =2, 3, 4, 12 or 14
- *Configuration 30*= "410 - IM: sensor-less field-orientated control (DMC)", asynchronous motor
- *Configuration 30*= "610 - PMSM: sensor-less field-orientated control (DMC)", synchronous motor

625 Brake release time

In order to protect the motor holding brake against damage, the motor may only start after the brake has been released. Startup to reference speed is effected only after the *Brake release time 625* has elapsed. The time should be set such that it is at least as long as the time required for releasing the holding brake. By using negative values for the parameter, release of the brake is delayed. This can be done in order to prevent loads from falling down, for example.

Parameters		Setting		
No.	Description	Min.	Max.	Fact. sett.
625	Brake release time	-5000 ms	5000 ms	0 ms

779 Minimum flux-formation time

The time required for flux-formation changes depending on the rotor time constant of the motor. By setting the parameters *Maximum flux-formation time 780* and *Minimum flux-formation time 779*, a constant flux-formation time can be reached. With the parameter *Minimum flux-formation time 779*, the minimum time for current impression is set. In this way, the time between a start signal and the start of the drive can be defined. For an appropriate setting of the parameters, the rotor time constant, the required starting torque and the parameter *Current during flux-formation 781* must be considered.

Parameters		Setting		
No.	Description	Min.	Max.	Fact. sett.
779	Minimum flux-formation time	1 ms	10000 ms	10 ms ¹⁾
				50 ms ²⁾

¹⁾Configuration **30** = 410

²⁾Configuration **30** = 610

<i>Minimum flux-formation time</i> 779 = 0	Flux-formation is stopped as soon <ul style="list-style-type: none"> – as the reference flux value or the – maximum flux-formation time were reached
<i>Minimum flux-formation time</i> 779 > 0	Current is impressed for flux-formation at least for this time even if the reference flux value was reached.
<i>Minimum flux-formation time</i> 779 = <i>Maximum flux-formation time</i> 780	Flux-formation is stopped after the set flux-formation time, regardless of whether the reference flux value was reached or not.
<i>Minimum flux-formation time</i> 779 < <i>Maximum flux-formation time</i> 780	Flux-formation is stopped after the maximum flux-formation time.

780 Maximum flux-formation time

781 Current during flux-formation

The field-orientated control is based on separate control of the flux-forming and the torque-forming current component. Upon startup, the machine is magnetized and a current is impressed first. With the parameter *Current during flux-formation* **781** the magnetization current I_{sd} is set, with the parameter *Maximum flux-formation time* **780** the maximum time for the current impression is set.

The current impression is done until the reference value of the rated magnetizing current is reached or the *Maximum flux-formation time* **780** is exceeded.

Parameters		Setting		
No.	Description	Min.	Max.	Fact. sett.
780	Maximum flux-formation time	1 ms	10000 ms	300 ms ¹⁾
				1000 ms ²⁾
				50 ms ³⁾
781	Current during flux-formation	$0.1 \cdot I_{FIN}$	$o_c \cdot I_{FIN}$	I_{FIN}

I_{FIN} : Nominal value of frequency inverter

o_c : Overload capacity of frequency inverter.

¹⁾Configuration **30** = 110

²⁾Configuration **30** = 410

³⁾Configuration **30** = 610

7.3.3 Stopping behaviour

630 Operation mode (P68&P69=1 | P68&P69=0)

The stopping behaviour can be defined via parameter *Operation mode (P68&P69=1 | P68&P69=0)* **630**. The signal states of the digital inputs or logic signals for parameters *Start clockwise* **68** and *Start anticlockwise* **69** activate the stopping procedure. Digital inputs or logic signals can be assigned to these parameters. In the factory settings, *Start clockwise* **68** is assigned "71 - IN1D" (terminal X11.4) and *Start anticlockwise* **69** is assigned "72 - IN2D" (terminal X11.5). By combination of the digital input states or logic signals, the stopping behaviours can be selected from the following table.

Operation mode Stopping behaviour							
<i>Operation mode (P68&P69=1 P68&P69=0)</i> 630		Start clockwise = 0 and Start anticlockwise = 0					
		Stopping behaviour (refer to table "Stopping behaviour")					
		0	1	2	4	5	7
Start clockwise = 1 and Start anticlockwise = 1	Stopping behaviour 0 (Coast to Stop)	0	1	2	4	5	7
	Stopping behaviour 1 (Stop and switch off)	10	11	12	14	15	17
	Stopping behaviour 2 (Stop and hold)	20	21	22	24	25	27
	Stopping behaviour 4 (Emergency stop and switch off)	40	41	42	44	45	47
	Stopping behaviour 5 (Emergency stop and hold)	50	51	52	54	55	57
	Stopping behaviour 7 (DC brake)	70	71	72	74	75	77

Operation mode **630** of the stopping behaviour is to be parameterized according to the matrix. The selection of the operation modes can vary according to the control method and the available control inputs.

Example:

The motor is to stop according to stopping behaviour 1 if the digital logic signals *Start Clockwise* **68** = 1 and *Start Anticlockwise* **69** = 1.

Additionally, the motor is to stop according to stopping behaviour 2 if the digital logic signals *Start Clockwise* **68** = 0 and *Start Anticlockwise* **69** = 0.

To achieve this, the value 12 (Stop, Off | Stop, Hold) must be set for parameter *Operation mode (P68&P69=1 | P68&P69=0)* **630**.

By selecting the stopping behaviour you also select the control of a mechanical brake if operation mode "41-Open brake" is used for one digital output for controlling the brake.

Stopping behaviour	
Stopping behaviour 0 Coast to Stop	The inverter is disabled immediately. The drive deenergized immediately and coasts freely.
Stopping behaviour 1 Stop and Switch off	The drive is brought to a standstill at the set deceleration. As soon as the drive is at a standstill, the inverter is disabled after a after a holding time. The holding time can be set via the parameter <i>Holding time stop function</i> 638 . Depending on the setting of the parameter <i>Operation mode</i> 620 the <i>Starting current</i> 623 is impressed or the <i>Starting voltage</i> 600 is applied for the duration of the holding time.
Stopping behaviour 2 Stop and hold	The drive is brought to a standstill at the set deceleration and remains permanently supplied with current. Depending on the setting of the parameter <i>Operation mode</i> 620 the <i>Starting current</i> 623 is impressed or the <i>Starting voltage</i> 600 is applied as from standstill.
Stopping behaviour 4 Emergency stop and Switch off	The drive is brought to a standstill at the emergency stop deceleration. As soon as the drive is at a standstill, the inverter is disabled after a after a holding time. The holding time can be set via the parameter <i>Holding time stop function</i> 638 . Depending on the setting of the parameter <i>Operation mode</i> 620 , the <i>Starting current</i> 623 is impressed or the <i>Starting voltage</i> 600 is applied as from standstill.
Stopping behaviour 5 Emergency stop and hold	The drive is brought to a standstill at the emergency stop deceleration and remains permanently supplied with current. Depending on the setting of the parameter <i>Operation mode</i> 620 the <i>Starting current</i> 623 is impressed or the <i>Starting voltage</i> 600 is applied as from standstill.
Stopping behaviour 7 DC brake	Direct current braking is activated immediately. In this process, the direct current set with parameter <i>Braking current</i> 631 is impressed for the <i>Braking time</i> 632 . Comply with the notes in chapter 7.3.6 "Direct current brake". Only available in the configuration 110 (V/f control).

Comply with chapter 7.6.5.5 "Release brake" on addressing mechanical brakes.

When a synchronous motor is connected, KÜENLE recommends setting *Operation mode* **630** = 22.

637 Switch-Off Threshold Stop Function

The *Switch-Off Threshold Stop Function* **637** defines the frequency as from which a stand-still of the drive is recognized. This percentage parameter value is relative to the set *Maximum frequency* **419**.

The switch-off threshold is to be adjusted according to the load behaviour of the drive and the device output, as the drive must be controlled to a speed below the switch-off threshold.

Parameters		Setting		
No.	Description	Min.	Max.	Fact. sett.
637	Switch-Off Threshold Stop Function	0.0%	100.0%	1.0%



WARNING

If the motor builds up a stopping torque, it may be possible that the switch-off threshold stop function is not reached due to the slip frequency and the standstill of the drive is not recognized. In this case, increase the value of the *Switch-off threshold stop function 637*.

638 Holding time stop function

The *Holding time stop function 638* is considered in stopping behaviours 1 and 4. Controlling to speed zero leads to a heating of the motor and should only be done for a short period in internally ventilated motors.

Parameters		Setting		
No.	Description	Min.	Max.	Fact. sett.
638	Holding time stop function	0.0 s	200.0 s	1.0 s

7.3.4 Auto start



WARNING

Comply with VDE provision 0100 part 227 and pro-vision 0113, in particular Sections 5.4, protection against automatic after main line voltage failure and voltage recovery, and Section 5.5 "Undervoltage protection".

Appropriate measures must be taken to exclude any risk for staff, machines and production goods.

In addition to that, all specific regulations relevant to the application as well all national directives are to be complied with.

651 Operation mode (Auto start)

The auto start function is suitable for applications which permit a start at mains voltage by their function. By activation of the auto start function via parameter *Operation mode 651*, the frequency inverter accelerates the drive after application of the mains voltage. Control signals STOA and STOB for enable and the start command are required as per the regulations. When the motor is switched on, it is accelerated according to the parameterization and the reference value signal.

<i>Operation mode 651</i>	Function
0 - Off	No auto start. The drive is accelerated, after application of the mains voltage, as soon as the enable and the start command are present (edge-triggered). Factory setting.
1 - Switched on	The drive is accelerated by the frequency inverter as soon as the mains voltage is applied (level-triggered).

7.3.5 Flying Start

645 Operation Mode Flying Start

The synchronization to a rotating drive is necessary in applications which drive the motor by their behaviour or in which the drive is still rotating after an error switch-off. Via *Operation Mode Flying Start 645*, the motor speed is synchronized to the current motor speed without an "Overcurrent" fault message. After this, the motor is accelerated to the reference speed at the set acceleration. This synchronization function determines the current rotary frequency of the drive via a search run.

The synchronization in operation modes 1 to 4 is accelerated by short test impulses. Rotary frequencies of up to 175 Hz are determined within 100 ms to 300 ms. For higher frequencies, a wrong frequency is determined and the synchronization fails. In operation modes 1 to 4, the Flying Start cannot determine whether a synchronization attempt has failed.

For operation of a synchronous motor, the flux direction can be determined in order to prevent alignment of the motor shaft (jerking) during start-up. Determining the flux direction takes approx. 20 ms. In this process, there are short torque pulses. This method is not suitable for very dynamic drives since the torque pulses result in a rotation of the drive and consequently in wrong measurements. Once the flux direction was determined, the flux is formed (Parameter *Minimum flux-formation time* **779**, *Maximum flux-formation time* **780**, *Current during flux-formation* **781**) in order to improve the starting behaviour.

<i>Operation Mode Flying Start</i> 645	Function
0 - Off	The synchronization to a rotating drive is de-activated. Factory setting.
1 - On	An attempt is made to synchronize to the drive in positive direction (clockwise field of rotation) and in negative direction (anticlockwise field of rotation). During operation of a synchronous motor (<i>Configuration</i> 30 = 610), the flux direction is determined additionally when the drive is at a standstill.
2 - On, according to reference	The search direction is defined by the sign of the reference value. If a positive reference value (clockwise field of rotation) is entered, the search is in a positive direction (clockwise field of rotation), with a negative reference value, the search is in a negative direction (anti-clockwise field of rotation). During operation of a synchronous motor (<i>Configuration</i> 30 = 610), the flux direction is determined additionally when the drive is at a standstill.
3 - On, clockwise only	Synchronization to the drive is only done in positive direction (clockwise field of rotation). During operation of a synchronous motor (<i>Configuration</i> 30 = 610), the flux direction is determined additionally when the drive is at a standstill.
4 - On, anticlockwise only	Synchronization to the drive is only done in negative direction (anticlockwise field of rotation). During operation of a synchronous motor (<i>Configuration</i> 30 = 610), the flux direction is determined additionally when the drive is at a standstill.
20 - Determine flux direction only	For a synchronous motor (<i>Configuration</i> 30 = 610), only the flux direction is determined. The drive must be at a standstill. Synchronization to a turning drive is not possible. This method is faster than operation modes 1 ... 4.
30 - Operation above frequency limit	For a synchronous motor (<i>Configuration</i> 30 = 610), only the Flying Start is performed. The search is continued until a rotary frequency is detected which is greater than the <i>Frequency limit</i> 624 . If the stator frequency drops below the frequency limit, the search run is continued. This operation mode can be used for synchronous motors in torque-controlled drives. An example application is the operation in wind energy converters. For an asynchronous motor (<i>Configuration</i> 30 = 410): Wait for speed. Applicable for torque-controlled drives which have to supply only reaction torque without active acceleration. If the drive is externally accelerated to the speed which is sufficient for sensor-less field-orientated control, switch-over to torque control is carried out.

Operation modes 2, 3 and 4 define a direction of rotation for the Flying Start and avoid a deviating direction. The Flying Start can accelerate drives by checking the rotary frequency if the drives have a low moment of inertia and/or a small load moment.

In operation modes 1 to 4, it cannot be ruled out that a wrong direction of rotation is determined. For example, a frequency not equal to zero may be determined although the drive is at a standstill. If there is no overcurrent, the drive is accelerated accordingly. The direction of rotation is defined in operation modes 2, 3 and 4.

NOTICE

The Flying Start function is designed for the operation of motors without brake. Brake motors may not be operated optimum in individual cases (depending of parameterization and brake control) with the Flying start function.

7.3.6 Direct current brake

631 Braking Current

632 Braking Time

Stopping behaviour 7 (Parameter *Operation Mode* **630**) includes the direct current brake. Using the direct current brake a motor can be decelerated faster than without direct current brake. By impressing a direct current part into the motor the losses inside the motor are artificially increased. The impression of the *Braking Current* **631** results in the motor heating up and should only be done for a short period in the case of internally ventilated motors.

Parameters		Setting		
No.	Description	Min.	Max.	Fact. sett.
631	Braking Current	0.00 A	$\sqrt{2} \cdot I_{FIN}$	$\sqrt{2} \cdot I_{FIN}$

I_{FIN} : Nominal value of frequency inverter

For the application of the Direct current brake the parameter *Configuration* **30** must be set to "110 - IM: sensor-less control" (control in accordance with V/f-characteristic).

The setting of the parameter *Braking Time* **632** defines the time-controlled stopping behaviour. Contact-controlled operation of the direct current brake is activated by entering the value zero for the *Braking Time* **632**.

TIME CONTROLLED:

The direct current is controlled by the status of the signals Start clockwise and Start anticlockwise. The current set by the parameter *Braking Current* **631** flows until the time set by the parameter *Braking Time* **632** has expired.

For the duration of the braking time, the combined control signals Start clockwise and Start anticlockwise must be logical 0 (Low) or 1 (High).

CONTACT-CONTROLLED:

If the parameter *Braking time* **632** is set to the value 0.0 s, the direct current brake is controlled by the Start clockwise and Start anticlockwise signals. The time monitoring and limitation by *Braking Time* **632** are deactivated. The braking current will be impressed until the controller enable control signal (STOA and STOB) becomes logical 0 (low).

Parameters		Setting		
No.	Description	Min.	Max.	Fact. sett.
632	Braking Time	0.0 s	200.0 s	10.0 s

633 Demagnetizing time

To avoid current surges, which can possibly lead to an error switch-off of the frequency inverter, a direct current may only be impressed into the motor after the motor has been demagnetized. As the demagnetization time depends on the motor used, it can be set with the parameter *Demagnetizing time* **633**.

The selected demagnetizing time should be approximately three times the *Act. Rotor Time Constant* **227**.

Parameters		Setting		
No.	Description	Min.	Max.	Fact. sett.
633	Demagnetizing Time	0.1 s	30.0 s	5.0 s

634 Amplification

635 Integral Time

The selected stopping behaviour is supplemented by a current controller to control the direct current brake. The PI controller controls the current impression of the parameterized *Braking Current* **631**. The proportional and integrating part of the current controller can be set via parameters *Amplification* **634** and *Integral Time* **635**. The control functions can be deactivated by setting the parameters to 0.

Parameters		Setting		
No.	Description	Min.	Max.	Fact. sett.
634	Amplification	0.00	10.00	1.00
635	Integral Time	0 ms	1000 ms	50 ms

7.3.7 Positioning

458 Operation Mode (Positioning)

Positioning is effected in operation mode "Reference positioning" via specification of the position distance.

Reference positioning uses a digital reference signal on digital input IN1D (terminal X11.4) for positioning the drive independent of the speed.

The function "Reference positioning" is available in configurations 110, 410 and 610 and is activated by selecting operation mode 1 for parameter *Operation Mode* **458**.

Operation mode 458	Function
0 - Off	Positioning switched off.
1 - Reference positioning	Reference positioning via definition of the positioning distance (revolutions). The reference point is identified via digital input IN1D (terminal X11.4).

459 Signal source

Reference positioning is started with the status change of the reference signal at digital input IN1D (terminal X11.4). Logic evaluation can be selected via the parameter signal source.

Signal source 459	Function
1 - IN1D, falling edge	The positioning starts with the change of the logic signal from 1 (High) to 0 (Low) at the reference point.
11 - IN1D, rising edge	The positioning starts with the change of the logic signal from 1 (Low) to 0 (High) at the reference point.
21 - IN1D, rising/falling edge	Positioning is started with a signal change at the reference point.

If the digital input IN1D is used for the reference signal, it must be checked if this input is linked to another function. By default, digital input IN1D has the function "Start clockwise" (Parameter *Start clockwise* **68**).

Do not use digital input IN1D for positioning and a stopping behaviour (parameter *Operation mode* **630**) at the same time.

460 Positioning distance

The feedback of the current position is referred to the revolutions of the motors relative to the time of the reference signal. The positioning accuracy depends on the current *Actual Frequency* **241**, the *Deceleration (clockwise)* **421**, the *No. of pole pairs* **373**, the selected *Positioning distance* **460** and the configured control behaviour.

The distance between the reference point and the required position is to be defined in motor revolutions. The calculation of the distance covered is done with the selected *Positioning distance* **460** according to the application.

The setting 0.000 U for the *Positioning distance* **460** causes an immediate stop of the drive according to the selected stopping behaviour for *Operation mode* **630**.

Parameters		Setting		
No.	Description	Min.	Max.	Fact. sett.
460	Positioning distance	0.000 U	1000000.000 U	0.000 U

U = Revolutions

The actual value parameter *Revolutions* **470** facilitates the setting and optimization of the function. The revolutions of the motor displayed should correspond to the *Positioning distance* **460** at the required position.

The minimum number of revolutions needed until the required position is reached depends on the *Actual frequency* **241** and *Deceleration (Clockwise)* **421** (or *Deceleration Anticlockwise* **423**) as well as the *No. of pole pairs* **373** of the motor.

$$U_{\text{minimum}} = \frac{f^2}{2 \cdot a \cdot p}$$

U_{min} = min. number of rotations
 f = *Actual frequency* **241**
 a = *Deceleration* **421** (or **423**)
 p = *No. of pole pairs* **373** of motor

Example: $f = 20 \text{ Hz}$, $a = 5 \text{ Hz/s}$, $p = 2 \Rightarrow U_{\text{min}} = 20$

With an actual frequency of 20 Hz and a delay of 5 Hz/s, at least 20 rotations are needed until standstill at the required position. This is the minimum value for the *Positioning distance* **460**, a shorter positioning distance is not possible. If the number of rotations until the required position is reached is to be lower, the frequency must be reduced, the deceleration increased, or the reference point must be shifted.

461 Signal correction

The registration of the reference position via a digital signal can be influenced by a variable dead time while the control command is read and processed. The signal running time is compensated by a positive figure for the *Signal correction* **461**. The setting of a negative signal correction decelerates the processing of the digital signal.

Parameters		Setting		
No.	Description	Min.	Max.	Fact. sett.
461	Signal correction	-327.68 ms	+327.67 ms	0.00 ms

462 Load correction

The influences on the positioning which depend on the operating point can be corrected empirically via parameter *Load correction* **462**. If the required position is not reached, the deceleration duration is increased by a positive load correction value. The distance between the reference point and the required position is extended. Negative values accelerate the braking process and reduce the positioning distance. The limit of the negative signal correction results from the application and the *Positioning distance* **460**.

Parameters		Setting		
No.	Description	Min.	Max.	Fact. sett.
462	Load correction	-32768	+32767	0

463 Activity after positioning

The behaviour of the positioning after the required position of the drive is reached can be defined via parameter *Activity after positioning* **463**.

Activity after positioning 463	Function
0 - End positioning	The drive is stopped with the stop-ping behaviour of <i>Operation mode 630</i> . In this setting only the second digit of <i>Operation mode 630</i> is evaluated. If the state "Hold" is selected, this state is considered, all other states will result in state "Switch Off".
1 - Waiting for positioning signal	The drive is stopped until the next signal edge; with a new edge of the position signal, it is accelerated in the previous direction of rotation.
2 - Reversal by new edge	The drive is held until the next signal edge; with a new edge of the position signal, it is accelerated in the opposite direction of rotation.
3 - Positioning; off	The drive is stopped and the power output stage of the inverter is switched off.
4 - Start by time control	The drive is stopped for the <i>Waiting Time 464</i> ; after the waiting time, it is accelerated in the previous direction of rotation.
5 - Reversal by time control	The drive is stopped for the <i>Waiting Time 464</i> ; after the waiting time, it is accelerated in the opposite direction of rotation.

464 Waiting Time

The position reached can be maintained for the *Waiting Time 464*, then the drive is accelerated according to operation mode 4 or 5.

Parameters		Setting		
No.	Description	Min.	Max.	Fact. sett.
464	Waiting Time	0 ms	3600000 ms	0 ms

Positioning, Operation Mode 458 = 1

The diagram shows how the positioning to the set positioning distance is effected. The positioning distance remains constant at different frequency values. At the reference point, the position signal S_{Posi} is generated. Starting from frequency f_{max} , the positioning is effected at the set *Deceleration (clockwise) 421*. At a lower frequency value f_1 , the frequency remains constant for some time before the drive is stopped at the set deceleration.

If, during acceleration or deceleration of the machine, positioning is started by the signal S_{Posi} , the frequency at the time of the positioning signal is maintained.

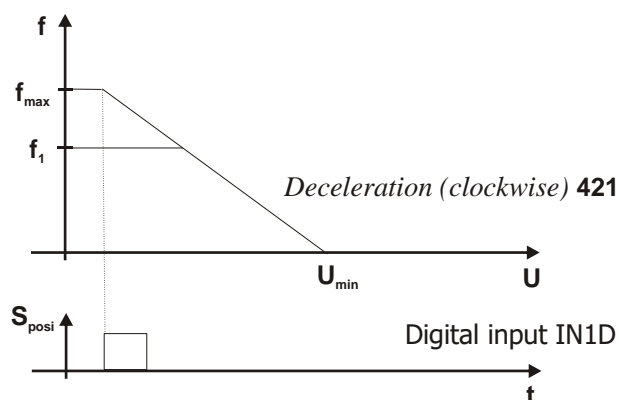

Examples of reference positioning as a function of the parameter settings selected:

- The reference point is identified by a signal at digital input IN1D (terminal X11.4).

- The *Positioning distance* **460** with parameter value 0.000U (default) defines a direct stop of the drive with the deceleration behaviour selected in parameter *Operation mode* **630** and the selected *Deceleration (clockwise)* **421**. If a *Positioning distance* **460** is set, the positioning is effected at the set deceleration.
- The *Signal correction* **461** of the signal run time from the measurement point to the frequency inverter is not used if it is set to 0 ms.
- The *Load correction* **462** can compensate a faulty positioning by the load behaviour. By default, this function is deactivated, i.e. set to 0.
- The *Activity after positioning* **463** is defined by operation mode 0 - "End positioning".
- The *Waiting Time* **464** is not considered because operation mode 0 is selected for the parameter *Action after positioning* **463**.
- Parameter *Revolutions* **470** shows the actual positioning distance and enables direct comparison to the required *Positioning distance* **460**. In the case of deviations, a *Signal correction* **461** or *Load correction* **462** can be performed.

7.4 Error and warning behaviour

Operation of the frequency inverter with the connected load is monitored continuously. The monitoring functions can be parameterized with the corresponding limit values specifically for the relevant application. If the limits were set below the switch-off limit of the frequency inverter, an error switch-off can be prevented by suitable measures if a warning message is issued.

The warning message can be read via parameter *Warnings* **269** or output via one of the digital control outputs.

7.4.1 Overload Ixt

405 Warning limit short-term Ixt

406 Warning limit long-term Ixt

The permissible load behaviour depends on the technical data of the frequency inverters and the ambient conditions.

The selected *Switching frequency* **400** defines the rated current and the available overload for one second or sixty seconds. The *Warning limit short-term Ixt* **405** and *Warning limit long-term Ixt* **406** are to be parameterized accordingly.

Parameters		Setting		
No.	Description	Min.	Max.	Fact. sett.
405	Warning limit short-term Ixt	6%	100%	80%
406	Warning limit long-term Ixt	6%	100%	80%

OUTPUT SIGNALS

Reaching of warning limits is reported via digital signals.

165 -	Warning Ixt	¹⁾	The <i>Warning Limit Short-Term Ixt</i> 405 or <i>Warning Limit Long-Term Ixt</i> 406 has been reached.
7 -	Ixt warning	²⁾	

¹⁾ For linking to frequency inverter functions.

²⁾ For output via a digital output. Select the signal source for one of the parameters 531, 532, 533, 554. See chapter 7.6.5 "Digital outputs".

7.4.2 Temperature

407 Warning limit heat sink temp.

408 Warning limit inside temp.

The ambient conditions and the energy dissipation at the current operating point result in the frequency inverter heating up. In order to avoid an error switch-off of the frequency inverter, the *Warning limit heat sink temp.* **407** for the heat sink temperature limit and the *Warning limit inside temp.* **408** as an internal temperature limit are to be parameterized. The temperature value at which a warning message is output is calculated from the type-dependent temperature limit minus the adjusted warning limit.

The switch-off limit of the frequency inverter is dependent of the construction size.

Parameters		Setting		
No.	Description	Min.	Max.	Fact. sett.
407	Warning limit heat sink temp.	-25 °C	0 °C	-5 °C
408	Warning limit inside temp.	-25 °C	0 °C	-5 °C

The exceeding of the maximum permissible internal temperature is signalled if the sensor for internal temperature or the sensor for the electrolytic capacitor temperature measures the type-specific limit value. For internal temperature and electrolytic capacitor temperature different limits are defined.

OUTPUT SIGNALS

Reaching of warning limits is reported via digital signals.

166 - 8	Heat sink temperature warning	1) 2)	The value "temperature limit minus <i>Warning limit heat sink temp. 407</i> " was reached.
167 - 9	Inside temperature warning	1) 2)	The value "temperature limit minus <i>Warning limit inside temp. 408</i> " was reached.
170 - 12	Warning over-temperature	1) 2)	The value <ul style="list-style-type: none"> - "temperature limit minus <i>Warning limit heat sink temp. 407</i>" or - "temperature limit minus <i>Warning limit inside temp. 408</i>" was reached.

1) For linking to frequency inverter functions.

2) For output via a digital output. Select the signal source for one of the parameters 531, 532, 533, 554. See chapter 7.6.5 "Digital outputs".

7.4.3 Controller status

409 Controller-Status Message

Intervention by a controller can be displayed via the operator panel. The selected control methods and the matching monitoring functions prevent a switch-off of the frequency inverter. The intervention of the function changes the operating behaviour of the application and can be displayed by the status messages with parameter *Controller status 275*. The limit values and events which result in the intervention by the corresponding controller are described in the corresponding chapters. The behaviour during the intervention of a controller is configured with the parameter *Controller-Status Message 409*.

<i>Controller-Status Message 409</i>	Function
0 - No Message	The intervention of a controller is not reported. The controllers influencing the operating behaviour are displayed in the <i>Controller status 275</i> parameter.
1 - Warning Status	The limitation by a controller is displayed as a warning by the operator panel.

Chapter 7.6.5.8 "Warning mask" contains a list of controllers and describes further ways for evaluating the controller states.

7.4.4 Frequency switch-off limit

417 Frequency Switch-off Limit

The maximum permissible output frequency of the frequency inverter can be set to a low frequency value via parameter *Frequency Switch-off Limit 417*. If this frequency limit is exceeded by the *Stator frequency 210* or the *Actual frequency 241*, the frequency inverter is switched off and error signal "F1100" is displayed.

Parameters		Setting		
No.	Description	Min.	Max.	Fact. sett.
417	Frequency Switch-off Limit	0.00 Hz	599.00 Hz	599.00 Hz

Please comply with the descriptions of parameters *Minimum frequency* **418** and *Maximum frequency* **419** in chapter 7.5.1.1 "Limits".

7.4.5 External error

535 Operation mode ext. error

Parameterization of an external error enables switching off or shutting down several frequency inverters at a time if a fault occurs in the plant or the drive. If an error occurs in a frequency inverter, the error signal can be transmitted via a bus system and the required reaction can be triggered in another frequency inverter. Parameter *External error* **183** can be assigned the logic signal or digital input signal which is to trigger the external error.

Via parameter *Operation mode ext. error* **535**, the response to an external error can be configured.

<i>Operation mode 535</i>	Function
0 - Disabled	No response to external errors.
1 - Error-Switch-Off	The drive is switched off and the error message "F1454 External Error" is output if the logic signal or digital input signal for parameter <i>External Error</i> 183 is present.
2 - Shutdown, Error	The drive is stopped at the current deceleration ramp and the error message "F1454 External Error" is output if the logic signal or digital input signal for parameter <i>External error</i> 183 is present.
3 - Emergency-Stop, Error	The drive is stopped at the set emergency stop ramp and the error message "F1454 External Error" is output if the logic signal or digital input signal for parameter <i>External error</i> 183 is present.

For setting up external warnings parameters *User Warning 1* **1363** and *User Warning 2* **1364** can be used. Check chapter 7.6.5.9 "Warning mask, application" for further details.

7.4.6 Motor temperature

570 Operation Mode Motor Temp.

Automatic shut-down of the frequency inverter or the output of a warning message offers protection against overheating of the motor. For monitoring the motor temperature, a temperature sensor must be connected to multifunction input 2. Parameter *Operation Mode Motor Temp.* **570** must be set according to the connected temperature sensor.

The motor temperature is evaluated via one of the following temperature sensors:

- Thermal contact (bimetal temperature sensor)
- PTC resistor (motor PTC)
- KTY measuring resistor
- Resistor PT1000

Motor temperature measurement enables:

- monitoring of temperature limits via a thermal contact or PTC resistor or
- temperature measurement, temperature monitoring and temperature display via a KTY measuring resistor or a resistor PT1000

<i>Operation Mode Motor Temp. 570</i>	Function
0 - Off	Motor temperature monitoring switched off.
1 - Therm.-Contact, P204: Warning only	Monitoring for temperature limit. A thermal overload is displayed via the operator panel and parameter <i>Warnings</i> 269 . For parameter <i>Thermal contact for P570</i> 204 , the digital input to which the thermal contact is connected must be selected. In the factory setup, multifunction input 2 can be used for connection of a thermal contact (<i>Thermal contact for P570</i> 204 is set to MF12D). The input signal must be digital. The evaluation (NPN/PNP) of the input signal can be set via parameter <i>Operation mode MF12</i> 562 .

Operation Mode Motor Temp. 570	Function
2 - Therm.-Contact, P204: Error Switch-Off	Monitoring for temperature limit. The frequency inverter is switched off immediately if the motor is thermally overloaded. The error switch-off is displayed by message F0400. For parameter <i>Thermal contact for P570 204</i> , the digital input to which the thermal contact is connected must be selected. In the factory setup, multifunction input 2 can be used for connection of a thermal contact (<i>Thermal contact for P570 204</i> is set to MFI2D). The input signal must be digital. The evaluation (NPN/PNP) of the input signal can be set via parameter <i>Operation mode MFI2 562</i> .
3 - Therm.-Contact, P204: Err.Switch-Off 1 min delayed	Monitoring for temperature limit. The frequency inverter is switched off if the motor is thermally overloaded. The error switch-off is displayed by message F0400. The error switch-off is delayed by one minute. For parameter <i>Thermal contact for P570 204</i> , the digital input to which the thermal contact is connected must be selected. In the factory setup, multifunction input 2 can be used for connection of a thermal contact (<i>Thermal contact for P570 204</i> is set to MFI2D). The input signal must be digital. The evaluation (NPN/PNP) of the input signal can be set via parameter <i>Operation mode MFI2 562</i> .
11 - MPTC, MFI2: Warning only	Monitoring for temperature limit. A thermal overload is displayed via the operator panel and parameter <i>Warnings 269</i> . Multifunction input 2 can be used as input for monitoring of a temperature value with motor PTC (PTC as per DIN 44081). The input signal must be analog.
12 - MPTC, MFI2: Error Switch-Off	Monitoring for temperature limit. The frequency inverter is switched off immediately if the motor is thermally overloaded. The error switch-off is displayed by message F0400. Multifunction input 2 can be used as input for monitoring of a temperature value with motor PTC (PTC as per DIN 44081). The input signal must be analog.
13 - MPTC, MFI2: Err.Switch-Off 1 min delayed	Monitoring for temperature limit. The frequency inverter is switched off if the motor is thermally overloaded. The error switch-off is displayed by message F0400. The error switch-off is delayed by one minute. Multifunction input 2 can be used as input for monitoring of a temperature value with motor PTC (PTC as per DIN 44081). The input signal must be analog.
21 - KTY, MFI2: Warning only	Temperature measurement. A thermal overload is displayed via the operator panel and parameter <i>Warnings 269</i> . The warning is displayed as soon as the value of <i>Max. Temp. Motor Winding 617</i> is reached. Multifunction input 2 can be reached as input for temperature measurement with a KTY measuring resistor (KTY84). The input signal must be analog. Parameter <i>Winding temperature 226</i> shows the actual value.
22 - KTY, MFI2: Error Switch-Off	Temperature measurement. The frequency inverter is switched off immediately as soon as the value of <i>Max. Temp. Motor Winding 617</i> is reached. The error switch-off is displayed by message F0400. Multifunction input 2 can be reached as input for temperature measurement with a KTY measuring resistor (KTY84). The input signal must be analog. Parameter <i>Winding Temperature 226</i> shows the actual value.
23 - KTY, MFI2: Err.Switch-Off 1 min delayed	Temperature measurement. The frequency inverter is switched off as soon as the value of <i>Max. Temp. Motor Winding 617</i> is reached. The error switch-off is displayed by message F0400. The error switch-off is delayed by one minute. Multifunction input 2 can be reached as input for temperature measurement with a KTY measuring resistor (KTY84). The input signal must be analog. Parameter <i>Winding Temperature 226</i> shows the actual value.

Operation Mode Motor Temp. 570	Function
31 - PT1000, MFI2: Warning only	Temperature measurement. A thermal overload is displayed via the operator panel and parameter <i>Warnings</i> 269 . The warning is displayed as soon as the value of <i>Max. Temp. Motor Winding</i> 617 is reached. Multifunction input 2 can be reached as input for temperature measurement with a measuring resistor PT1000. The input signal must be analog. Parameter <i>Winding Temperature</i> 226 shows the actual value.
32 - PT1000, MFI2: Error Switch-Off	Temperature measurement. The frequency inverter is switched off immediately as soon as the value of <i>Max. Temp. Motor Winding</i> 617 is reached. The error switch-off is displayed by message F0400. Multifunction input 2 can be reached as input for temperature measurement with a measuring resistor PT1000. The input signal must be analog. Parameter <i>Winding Temperature</i> 226 shows the actual value.
33 - PT1000, MFI2: Err.Switch-Off 1 min delayed	Temperature measurement. The frequency inverter is switched off as soon as the value of <i>Max. Temp. Motor Winding</i> 617 is reached. The error switch-off is displayed by message F0400. The error switch-off is delayed by one minute. Multifunction input 2 can be reached as input for temperature measurement with a measuring resistor PT1000. The input signal must be analog. Parameter <i>Winding Temperature</i> 226 shows the actual value.

Error Acknowledgment

- Thermal contact or MPTC: An error message can be acknowledged if the sensor does not signal overtemperature anymore.
- KTY or PT1000: An error message can be acknowledged if the motor temperature has dropped below the switch-off threshold by 5°C.

Possibilities of error acknowledgement:

- via operator panel or
- via parameter *Error Acknowledgement* **103** which is assigned a logic signal or a digital input

Evaluation of the motor temperature is independent of the controller enable.



If motor temperature monitoring with MPTC, KTY or PT1000 is selected via parameter *Operation Mode Motor Temp.* **570**, multifunction input 2 cannot be used for other functions. In this case, parameters 560 ... 567 of multifunction input 2 don't have any function.



If motor temperature monitoring with thermal contact is selected via parameter *Operation Mode Motor Temp.* **570**, multifunction input 2 can only be set, via parameter *Operation mode MFI2* **562** to "3 - Digital NPN (active: 0 V)" or "4 - Digital PNP (active: 24 V)". In this case, multifunction input 2 cannot be used for controlling other functions.



If another digital input is used for connection of the thermal contact, this input must be selected for parameter *Thermal contact for P570* **204**.



Multifunction input 2 can be used for other functions if the factory setting is changed for parameter *Thermal contact for P570* **204** (i.e. if a digital input is selected, not multifunction input 2).

617 Max. Temp. Motor Winding

Via parameter *Max. Temp. Motor Winding* **617**, you can set the temperature value above which a warning message is output or an error switch-off of the frequency inverter is effected.

The value of *Max. Temp. Motor Winding* **617** is evaluated if the analog signal of a temperature sensor is connected to multifunction input 2 and one of the following settings is selected for parameter *Operation Mode Motor Temp.* **570**:

- 21 ... 23: KTY
- 31 ... 33: PT1000

Parameters		Setting		
No.	Description	Min.	Max.	Fact. sett.
617	Max. Temp. Motor Winding	0 °C	200 °C	150 °C

OUTPUT SIGNALS

Warnings are displayed in parameter *Warnings* **269** and output via digital signals.

168 -	¹⁾	Motortemperature warning	The monitoring function – selected via <i>Operation Mode Motor Temp.</i> 570 – signals a thermal overload or reaching of the value of <i>Max. Temp. Motor Winding</i> 617 .
10 -	²⁾		
17 -	³⁾		

¹⁾ For linking to frequency inverter functions.

²⁾ For output via a digital output. Select the signal source for one of the parameters 531, 532, 533, 554. See chapter 7.6.5 "Digital outputs".

³⁾ For monitoring via parameter *Create Warning Mask* **536**.

7.4.6.1 Technical demands on measuring resistors

PTC RESISTOR

Multifunction input 2 (terminal X12.4) is designed for connection of a PTC resistor with the following specifications:

- Rated response temperature: 90 °C to 160 °C in steps of 10 K
- Temperature characteristic: according to DIN 44081

KTY84 MEASURING RESISTOR

Multifunction input 2 (terminal X12.4) is designed for connection of a KTY84 measuring resistor with the following specifications:

- Resistance: 1 kΩ at 100 °C ambient temperature
- Measuring range: -40 ... 300 °C
- Temperature coefficient: 0.61%/K

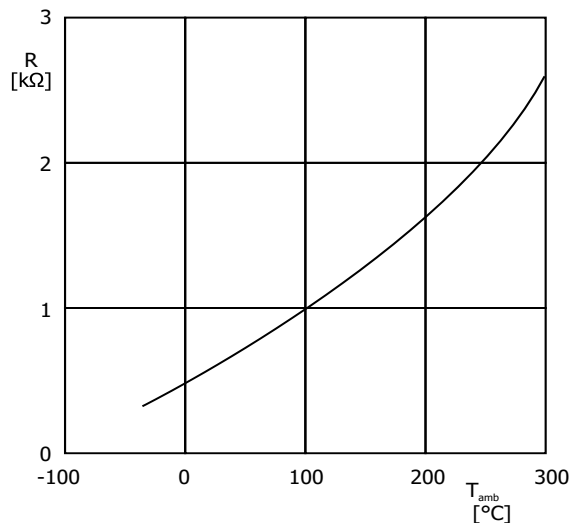

KTY resistance R depending on ambient temperature T_{amb}

MEASURING RESISTOR PT1000

Multifunction input 2 is designed for connection of a PT 1000 measuring resistor with the following specifications:

- Resistance: 1 kΩ at 0 °C ambient temperature
- Measuring range: -40 ... 550 °C

Connection

Thermal contact

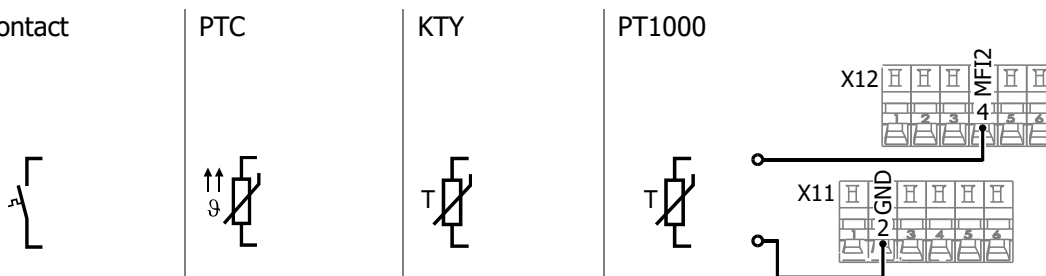

Operation mode motor temp. **570** =

- | | | | |
|-----------|--------------|--------------|--------------|
| 1, 2 or 3 | 11, 12 or 13 | 21, 22 or 23 | 31, 32 or 33 |
|-----------|--------------|--------------|--------------|

Thermal contact for

- P570 **204**,=
- 532 - MFI2D (Hardware)

7.4.7 Phase failure

576 Phase Supervision

If a failure of one of the three motor or mains phases is not noticed, the frequency inverter, the motor and the mechanical drive components may be damaged. In order to prevent these components from being damaged, the phases are monitored for failure. Via parameter *Phase Supervision* **576**, the behaviour in case of a phase failure can be set.

Phase Supervision 576	Function
10 - Mains: Error Switch-Off	In the case of a phase failure, the error switch-off takes place after 5 minutes, fault F0703 is displayed. During this time, the warning message A0100 is displayed.
11 - Mains & Motor: Error Switch-Off	The phase monitor switches the frequency inverter off: <ul style="list-style-type: none"> – immediately with error message F0403 in the case of a motor phase failure – after 5 minutes with error message F0703 in the case of a mains phase failure
20 - Mains: Shutdown	In the case of a mains phase failure, the drive is stopped after 5 minutes, fault F0703 is displayed.
21 - Mains & Motor: Shutdown	<ul style="list-style-type: none"> – The drive is switched off: immediately, in the case of a motor phase failure – The drive is stopped: after 5 minutes in the case of a mains phase failure

7.4.8 Automatic Error Acknowledgment

578 Allowed No. of Auto-Acknowl.

579 Restart Delay

The automatic error acknowledgment allows acknowledgment of the faults Overcurrent F0507 and Overvoltage F0700 without intervention by an overriding control system or the user. If one of the aforementioned errors occurs, the frequency inverter switches the power semi-conductors off and waits for the time stated with the parameter *Restart Delay* **579**. If the error is acknowledged, the speed of the machine is determined with the quick Search Run function and synchronized to the rotating machine. The automatic error acknowledgment makes use of "Quick Synchronization" operation mode, regardless of the *Flying Start Operation Mode* **645**. The information given on this function in chapter 7.3.5 "Flying Start" must be observed.

If an error occurs during the quick Search Run, subsequently leading to stopping of the inverter, the **P.259** saves the error leading to the stop.

However, in the error log the initial auto-acknowledged error (e. g. F0507) is saved. This behavior allows a wider range of data to be saved thus facilitating the later investigation of root causes.

With parameter *Allowed No. of Auto-Acknowl.* **578**, you can define the number of automatic error acknowledgements which are permitted within 10 minutes.

An acknowledgement repeated above the permissible number within 10 minutes will result in the frequency inverter being switched off.

The errors Overcurrent F0507 and Overvoltage F0700 have separate error acknowledgement counters.

Parameters		Setting		
No.	Description	Min.	Max.	Fact. sett.
578	Allowed No. of Auto-Acknowl.	0	20	5
579	Restart Delay	0 ms	1000 ms	20 ms

7.5 Reference Values

7.5.1 Reference frequency channel

475 Reference Frequency Source 1

492 Reference Frequency Source 2

Via the reference frequency channel, you can define how the reference rotary frequency for the motor is to be specified. For each of parameters *Reference Frequency Source 1* **475** and *Reference Frequency Source 2* **492**, you can select a reference value specification option. The selected reference values are added and output as rotary frequency reference value for the motor.

The settings of frequency limits (Parameter *Minimum Frequency* **418** and *Maximum Frequency* **419**) and blocking frequencies (parameter *1st Blocking Frequency* **447**, *2nd Blocking Frequency* **448**) as well as *Frequency Hysteresis* **449** are considered.



If the same setting is selected for parameter *Reference Frequency Source 1 475* and *Reference Frequency Source 2 492*, the reference value is not doubled. In this case the reference value is the single value of the selected reference value source.

SELECTION OF SOURCE FOR REFERENCE VALUE:

Reference Frequency Source 1 475 Reference Frequency Source 2 492	Function
0 - Zero	Reference value is zero.
1 - Analog Value MFI1A	Multifunction input 1 is the reference value source. Via parameter <i>Operation Mode MF11 452</i> , the input must be set up as an analog input (voltage or current). By setting the voltage or current value at multifunction input 1, you can set the output frequency. Factory setting for <i>Reference Frequency Source 1 475</i> . See chapter 7.6.1 "Multifunction input MFI1".
2 - Analog Value MFI2A	Multifunction input 2 is the reference value source. Via parameter <i>Operation mode MF12 562</i> , the input must be set up as an analog input (voltage or current). By setting the voltage or current value at multifunction input 2, you can set the output frequency. See chapter 7.6.2 "Multifunction input MFI2".
3 - Fixed Frequency	The selected fixed frequency is the reference value source. The fixed frequency of the current data set is selected via <i>Fixed frequency changeover 1 66</i> , <i>Fixed frequency changeover 2 67</i> and <i>Fixed frequency changeover 3 131</i> . The fixed frequency values can be set in parameters 480 ... 488. See chapter 7.5.1.3 "Fixed frequencies".
4 - Motorpot. via Digital Inputs	Reference value source is the function <i>Frequency motorpoti up 62</i> and <i>Frequency motorpoti down 63</i> . The output frequency can be set by digital signals. See chapter 7.5.3 "Motor potentiometer".
5 - Keypad-Motorpot.	Reference value source is the function <i>Frequency motorpoti up 62</i> and <i>Frequency motorpoti down 63</i> . The output frequency can be set by digital signals. See chapter 7.5.3.4.1 "Control via reference frequency channel".
10 - Repetition Frequency	The frequency signal at digital input IN2D is the reference value source. For parameter <i>Operation mode IN2D 496</i> of the repetition frequency input, "20 - repetition frequency single evaluation" or "21 - repetition frequency double evaluation" must be selected. See chapter 7.6.7.2 "Repetition frequency input".
20 - Fieldbus Reference Value	The reference value is transmitted via a bus system. Profibus: The value of PZD2 is used as reference value. CANopen: The value of object 0x6042 Target Velocity is used as reference value.
30 - Technology Controller	The output of the PID controller is the reference value source. If this source is selected for <i>Reference frequency source 1 475</i> or <i>Reference frequency source 2 492</i> , the technology controller is switched on. See chapter 7.9.3 "PID controller (technology controller)".
40 - electr. Gear	The output of the electronic gear is the reference value source. If this source is selected for <i>Reference frequency source 1 475</i> or <i>Reference frequency source 2 492</i> , the electronic gear is switched on. See chapter 7.5.4 "Electronic gear".
2501 - PLC Output Frequency 1	Frequency output 1 of a PLC function block is the reference value source. See application manual "PLC".

Reference Frequency Source 1 475 Reference Frequency Source 2 492	Function
2502 - PLC Output Frequency 2	Frequency output 2 of a PLC function block is the reference value source. See application manual "PLC".

The reference frequency channel can be used in all configurations (parameter *Configuration 30*).

Block diagram

The block diagram shows the reference frequency specification options.

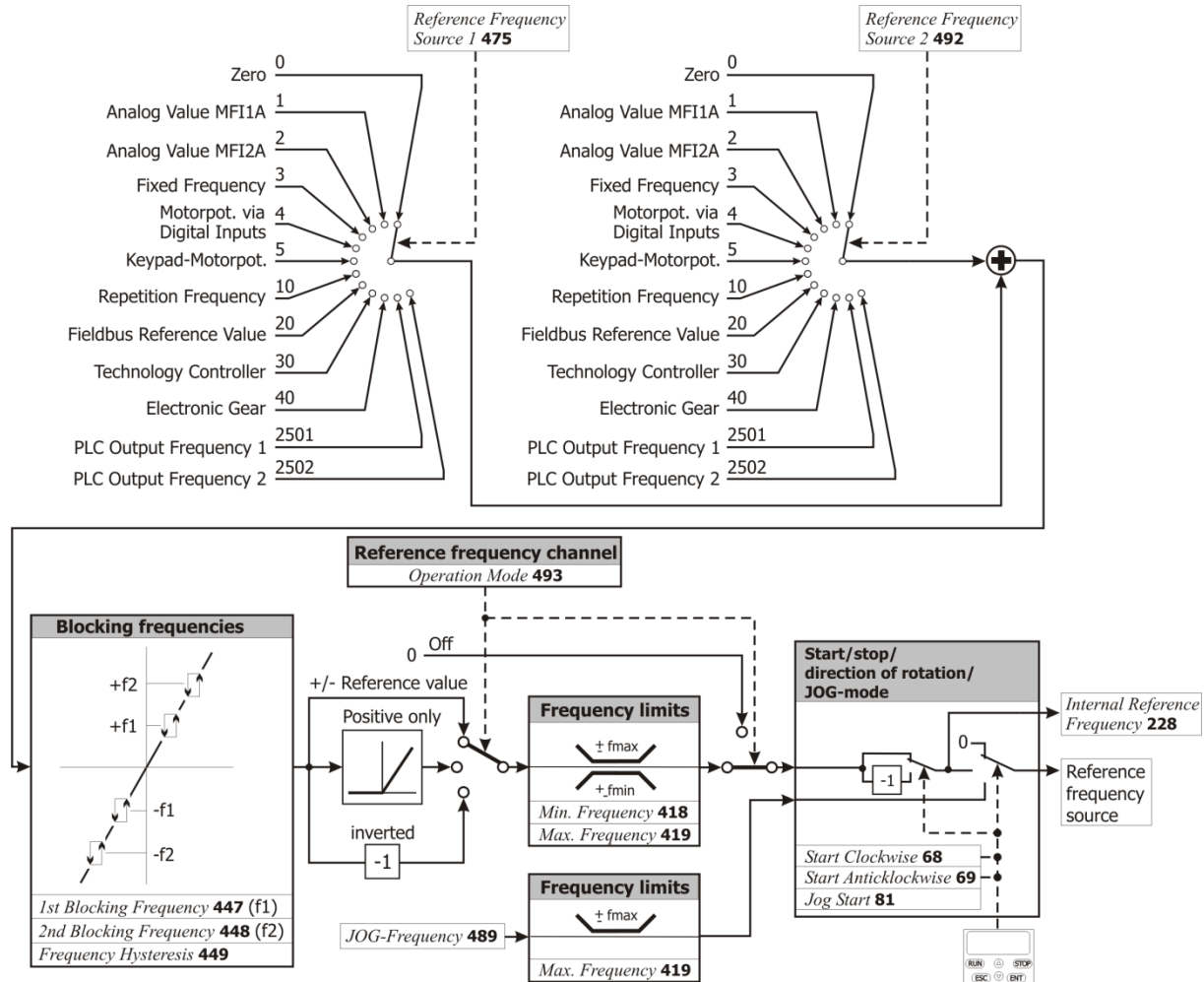

Lock the reference value facilities of the control panel

If the setting possibility of the reference frequency at the operator panel must be locked:

- For parameter *Reference Frequency Source 1 475* the setting "5 - Keypad-Motorpot." must not be selected and
- for parameter *Reference Frequency Source 2 492* the setting "5 - Keypad-Motorpot." must not be selected.
 - Set parameter *Set Password 27* to prevent the resetting of parameters. Refer to chapter 7.1.3 "Set password".

NOTICE

The setting of Parameter *Set Password 27* only does not lock the control facilities of the keypad. Start, Stop, Change direction of rotation, Poti F and Poti P are still available.

7.5.1.1 Limits

418 Minimum Frequency

419 Maximum Frequency

The area of the output frequency of the frequency inverter and thus the speed setting range are defined by the parameters *Minimum Frequency 418* and *Maximum Frequency 419*. The corresponding control methods use the two limit values for scaling and calculating the frequency.

Parameters		Setting		
No.	Description	Min.	Max.	Fact. sett.
418	Minimum Frequency	0.00 Hz	599.00 Hz	3.50 Hz
419	Maximum Frequency	0.00 Hz	599.00 Hz	50.00 Hz

The parameters *Minimum Frequency 418* and *Maximum Frequency 419* can only be changed while the output stage is inhibited.

719 Slip Frequency

The torque-forming current component and thus the slip frequency of the 3-phase machine depend on the required torque in the case of the field-orientated control methods. The field-orientated control method also includes the parameter *Slip Frequency 719* to limit the torque in the calculation of the machine model. The rated slip calculated from the rated motor parameters is limited in accordance with the *Slip Frequency 719* which is parameterized as a percentage.

Parameters		Setting		
No.	Description	Min.	Max.	Fact. sett.
719	Slip Frequency	0%	10000%	330%

7.5.1.2 Positive and negative reference frequencies

493 Operation Mode (reference frequency source)

Via parameter *Operation Mode 493*, you can define if the reference frequency value set via parameters *Reference Frequency Source 1 475* and *Reference Frequency Source 2 492* is to be either positive or negative only or if it can be both positive and negative. You can also output the reference frequency as an inverted value (compared to the selected reference value source).

Operation Mode 493	Function
0 - Off	The reference frequency channel is switched off. The reference frequency is 0 Hz.
1 - +/- reference value	The reference frequency can be both positive and negative. The values of <i>Reference frequency source 1 475</i> and <i>Reference frequency source 2 492</i> are added up. Factory setting.
2 - Positive only	The reference frequency can only be positive. The reference frequency is limited to the range from 0 Hz to the <i>Maximum frequency 419</i> . The values of <i>Reference frequency source 1 475</i> and <i>Reference frequency source 2 492</i> are added up, then the result is limited to positive values.
3 - Inverted	The reference frequency is inverted (compared to the sign of the selected reference value source). The values of <i>Reference frequency source 1 475</i> and <i>Reference frequency source 2 492</i> are added up, then the result is inverted.

7.5.1.3 Fixed frequencies

480 Fixed frequency 1

481 Fixed frequency 2

482 Fixed frequency 3

483 Fixed frequency 4

485 Fixed frequency 5

486 Fixed frequency 6

487 Fixed frequency 7

488 Fixed frequency 8

Via digital logic signals or digital inputs fixed preset reference values can be selected.

The fixed frequencies are reference values for the rotary frequency of the motor. Eight fixed frequencies can be set. The fixed frequencies can be selected via *Fixed Frequency Change-Over 1* **66**, *Fixed Frequency Change-Over 2* **67** and *Fixed Frequency Change-Over 3* **131**. Logic signals or digital inputs must be assigned to the parameters *Fixed Frequency Change-Over 1* **66**, *Fixed Frequency Change-Over 2* **67** and *Fixed Frequency Change-Over 3* **131**.

Via the reference frequency channel (see chapter 7.5.1 "Reference frequency channel") the fixed frequencies can be selected and linked to other reference value sources. Linking is effected via parameters *Reference Frequency Source 1* **475** and *Reference Frequency Source 2* **492**.

Parameters		Setting		
No.	Description	Min.	Max.	Fact. sett.
480	Fixed Frequency 1	-599.00 Hz	599.00 Hz	0.00 Hz
481	Fixed Frequency 2	-599.00 Hz	599.00 Hz	10.00 Hz
482	Fixed Frequency 3	-599.00 Hz	599.00 Hz	25.00 Hz
483	Fixed Frequency 4	-599.00 Hz	599.00 Hz	50.00 Hz
485	Fixed Frequency 5	-599.00 Hz	599.00 Hz	5.00 Hz
486	Fixed Frequency 6	-599.00 Hz	599.00 Hz	10.00 Hz
487	Fixed Frequency 7	-599.00 Hz	599.00 Hz	25.00 Hz
488	Fixed Frequency 8	-599.00 Hz	599.00 Hz	50.00 Hz

- Set the required number of fixed frequencies (parameters 480 ... 488).
- For fixed frequency changeover (parameters 66, 67, 131), select digital inputs.
- Select fixed frequencies with signals at digital inputs.

66 Fixed Frequency Change-Over 1

67 Fixed Frequency Change-Over 2

131 Fixed Frequency Change-Over 3

By combining the logic states of the fixed frequency change-over inputs 1, 2 and 3, fixed frequencies 1 through 8 (parameters 480 to 488) can be selected.

Selection of fixed frequencies				
<i>Fixed Frequency Change-Over 1</i> 66	<i>Fixed Frequency Change-Over 2</i> 67	<i>Fixed Frequency Change-Over 3</i> 131	Active fixed value	Factory setting
0	0	0	<i>Fixed frequency 1</i> 480	0 Hz
1	0	0	<i>Fixed frequency 2</i> 481	10 Hz
1	1	0	<i>Fixed frequency 3</i> 482	25 Hz
0	1	0	<i>Fixed frequency 4</i> 483	50 Hz
0	1	1	<i>Fixed frequency 5</i> 485	5 Hz
1	1	1	<i>Fixed frequency 6</i> 486	10 Hz
1	0	1	<i>Fixed frequency 7</i> 487	25 Hz
0	0	1	<i>Fixed frequency 8</i> 488	50 Hz

0 = contact open 1 = contact closed

Number of digital inputs	Number of fixed frequencies per data set
1	2
2	4
3	8

Fixed frequency change-over factory settings:

No.	Parameters	Setting
66	Fixed frequency change-over 1	74 – IN4D
67	Fixed frequency change-over 2	7 - Off
131	Fixed frequency change-over 3	7 - Off

If the data set changeover function is used additionally via parameters *Data Set Change-Over 1* **70** and *Data Set Change-Over 2* **71**, you can preset up to 32 fixed frequencies as reference values.

The fixed frequency changeover can also be controlled via digital signals (instead of digital inputs) by functions of the frequency inverter.

Via parameter *Operation Mode* **493**, you can change the direction of rotation of the motor. See chapter 7.5.1.2 "Positive and negative reference frequencies". The direction of rotation can also be preset with the digital signal sources assigned to the parameters *Start Clockwise* **68** and *Start Anticlockwise* **69**.

Via the reference frequency channel (see chapter 7.5.1 "Reference frequency channel"), the fixed reference values can be selected and linked to other reference value sources.

7.5.1.4 Ramps

420 Acceleration (Clockwise)

421 Deceleration (Clockwise)

422 Acceleration Anticlockwise

423 Deceleration Anticlockwise

The ramps determine how quickly the frequency value is changed if the reference value changes or after a start, stop or brake command. The maximum admissible ramp gradient can be selected according to the application and the current consumption of the motor.

For setting identical frequency ramps for both directions of rotation, the parameterization via the parameters *Acceleration (Clockwise)* **420** and *Deceleration (Clockwise)* **421** is sufficient. The values of the frequency ramps are taken over for *Acceleration Anticlockwise* **422** and *Deceleration Anticlockwise* **423** if these have been parameterized to the factory setting of -0.01 Hz/s.

The parameter value of 0.00 Hz/s for the acceleration blocks the corresponding direction of rotation.

A set *Ramp Rise Time* **430** affects the ramps.

Parameters		Setting		
No.	Description	Min.	Max.	Fact. sett.
420	Acceleration (Clockwise)	0.00 Hz/s	9999.99 Hz/s	5.00 Hz/s
421	Deceleration (Clockwise)	-0.01 Hz/s ¹⁾	9999.99 Hz/s	5.00 Hz/s
422	Acceleration Anticlockwise	-0.01 Hz/s ²⁾	9999.99 Hz/s	-0.01 Hz/s ²⁾
423	Deceleration Anticlockwise	-0.01 Hz/s ²⁾	9999.99 Hz/s	-0.01 Hz/s ²⁾

¹⁾ Value -0.01 Hz/s means: *Acceleration (Clockwise)* **420** is applied.

²⁾ Value -0.01 Hz/s means: The ramps of clockwise operation are applied.



The setting 0.00 Hz/s won't accelerate or decelerate the drive due to the limitation of the ramp.

424 Emergency Stop Clockwise

425 Emergency Stop Anticlockwise

The ramps for the *Emergency Stop Clockwise* **424** and *Emergency Stop Anticlockwise* **425** of the drive to be activated via *Operation Mode* **630** for the stopping behaviour must be selected according to the application. The non-linear (S-shaped) curve of the ramps is not active in the case of an emergency stop of the drive.

Parameters		Setting		
No.	Description	Min.	Max.	Fact. sett.
424	Emergency Stop Clockwise	0.01 Hz/s	9999.99 Hz/s	5.00 Hz/s
425	Emergency Stop Anticlockwise	0.01 Hz/s	9999.99 Hz/s	5.00 Hz/s

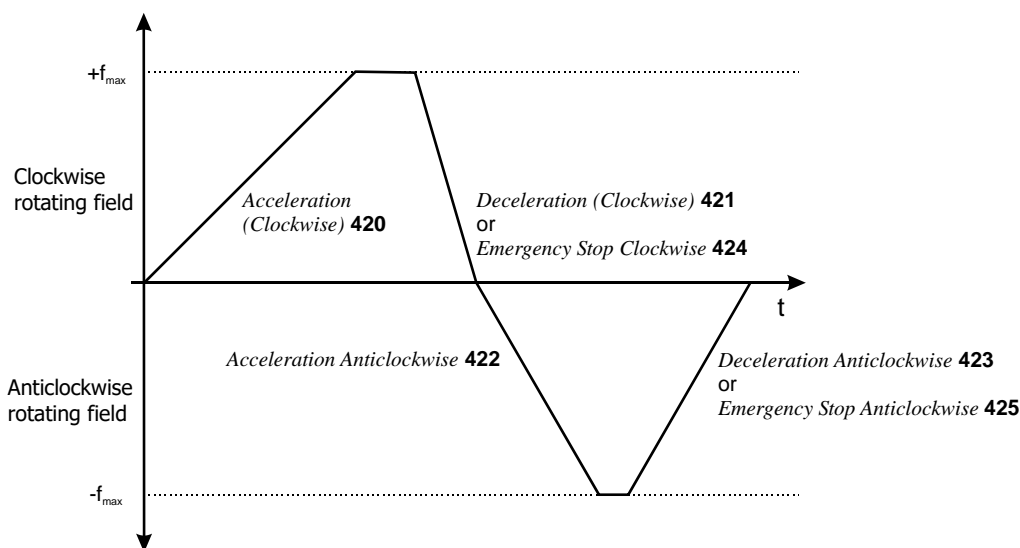

426 Maximum Leading

The parameter *Maximum Leading* **426** limits the difference between the output of the ramp and the current actual value of the drive. The set maximum deviation is a dead time for the control system which should be kept as low as possible.

In case the drive is loaded heavily and high acceleration and deceleration values are selected it is possible, that a set controller limit is reached while the drive is accelerated or decelerated. In this case, the drive cannot follow the defined acceleration or deceleration ramps. With *Maximum Leading* **426**, you can limit the maximum leading of the ramp.

Parameters		Setting		
No.	Description	Min.	Max.	Fact. sett.
426	Maximum Leading	0.01 Hz	599.00 Hz	5.00 Hz

Example: Frequency at ramp output = 20 Hz, current actual value of drive = 15 Hz, selected *Maximum Leading* **426** = 5 Hz

The frequency at the ramp output is increased to 20 Hz only, it is not increased further. The difference (leading) between the frequency value at the ramp output and the current actual frequency of the drive is limited to 5 Hz in this way.

430 Ramp Rise Time

The load occurring in a linear acceleration of the drive is reduced by the adjustable modification speed (S-curve). Via the S-curve, the drive can be accelerated and decelerated more uniformly and load peaks upon the start of the acceleration and deceleration can be avoided. The non-linear curve of the frequency indicates states the time range in which the frequency is to be guided to the set ramp. Setting the ramp rise time increases the acceleration and deceleration times.

The value set for the *Ramp Rise Time* **430** is effective for:

- acceleration and deceleration
- clockwise and anticlockwise operation

If the ramp time is set to 0 ms, the S curve is deactivated.

Parameters		Setting		
No.	Description	Min.	Max.	Fact. sett.
430	Ramp Rise Time	0 ms	10000 ms	0 ms

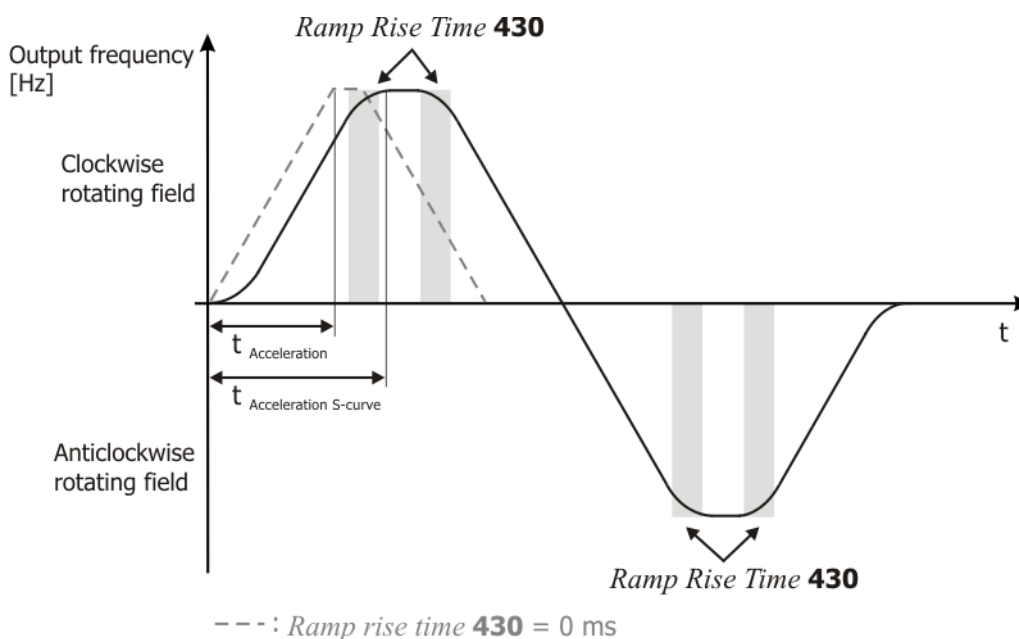



If the data set is changed during acceleration or deceleration, it is ensured that the S-curve of the previous data set is finished first. Unintentional jumps between different gradients of the S-curve are avoided.

7.5.1.5 Blocking frequencies

447 1st Blocking Frequency

448 2nd Blocking Frequency

449 Frequency Hysteresis

In certain applications, it is necessary to block out reference frequencies. In this way, resonance points of the system as stationary operating points are avoided. The parameters *1st Blocking Frequency* **447**, *2nd Blocking Frequency* **448** and *Frequency Hysteresis* **449** define two resonance points.

A blocking frequency is active if the parameter values of the blocking frequency and the frequency hysteresis are not equal to 0.00 Hz.

The area faded out as a stationary working point by the hysteresis is passed through as quickly as possible according to the ramp set. If the output frequency is limited as a result of the selected control parameter settings, e.g. if the current limit is reached, the hysteresis is passed through with a delay. The behaviour of the reference value can be determined from its direction of movement according to the following diagram.

Parameters		Setting		
No.	Description	Min.	Max.	Fact. sett.
447	1st Blocking Frequency	0.00 Hz	599.00 Hz	0.00 Hz
448	2nd Blocking Frequency	0.00 Hz	599.00 Hz	0.00 Hz
449	Frequency Hysteresis	0.00 Hz	100.00 Hz	0.00 Hz

Reference value output

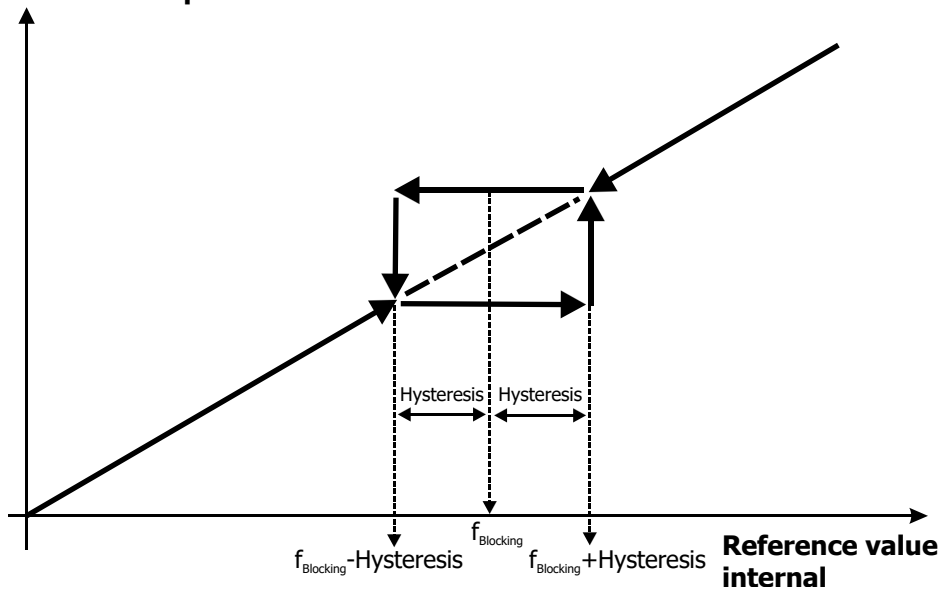

7.5.1.6 JOG frequency

81 JOG Start

489 JOG Frequency

The drive rotates at a preset frequency when the JOG function is started. The rotary frequency can be set via the parameter *JOG Frequency* **489**.

The JOG function can be started:

- Via the button "RUN" on the operator panel. The "JOG" menu must be selected.
- Via parameter *JOG Start* **81**. The parameter must be assigned a logic signal or a digital input.

Preconditions for start of JOG function:

- Enable via digital inputs STOA and STOB must be set.
- Signals for parameters *Start Clockwise* **68** and *Start Anticlockwise* **69** must not be set.

Parameters		Setting		
No.	Description	Min.	Max.	Fact. sett.
489	JOG Frequency	-599.00 Hz	599.00 Hz	5.00 Hz

Positive values of *JOG Frequency* **489** effect clockwise rotation, negative values effect anticlockwise rotation.

<i>JOG Start</i> 81	Function
Selection of signal source	The selected signal source starts the JOG function. The drive is accelerated to the value of <i>JOG Frequency</i> 489 .

Acceleration and deceleration

If enable is set and the JOG function is started, the drive is accelerated at the set frequency ramps to the value of *JOG Frequency* **489**.

If the signal *JOG Start* **81** is reset (or the button "RUN" is released), the drive is decelerated at the set frequency ramps until it comes to a standstill.

Limit

The output frequency is limited to the value of *Maximum Frequency* **419**. There is no limitation to the value of *Minimum Frequency* **418**. Blocking frequencies (parameters 447 to 449) are not considered.



Controls via *JOG Start* **81** and button "RUN" in "JOG" menu may be used at the same time.

If a start command is issued during JOG operation (Parameter *Start Clockwise* **68** or *Start Anticlockwise* **69**), the frequency inverter returns to normal operation mode. If the start command is reset, the frequency inverter returns to JOG operation again.

7.5.2 Reference percentage channel

476 Reference Percentage Source 1

494 Reference Percentage Source 2

The reference percentage channel combines various signal sources for definition of the reference figures. The percentage scaling facilitates integration into the application and processing of process parameters. Reference percentages may be used, for example, for setting reference values for the PID controller (technology controller) of torques.

For each of parameters *Reference Percentage Source 1* **476** and *Reference Percentage Source 2* **494**, you can select a reference value source. The selected reference values are added.

Percentage value limit settings (Parameter *Minimum Reference Percentage* **518** and *Maximum Reference Percentage* **519**) are considered.



If the same setting is selected for parameter *Reference Percentage Source 1* **476** and *Reference Percentage Source 2* **494**, the reference value is not doubled. In this case the reference value is the single value of the selected reference value source.

SELECTION OF SOURCE FOR REFERENCE VALUE:

<i>Reference Percentage Source 1</i> 476 <i>Reference Percentage Source 2</i> 494	Function
0 - Zero	Reference value is zero.
1 - Analog Value MFI1A	Multifunction input 1 is the reference value source (terminal X12.3). Via <i>Operation mode MFI1</i> 452 , the input must be set up as an analog input (voltage or current). Factory setting for <i>Reference percentage source 1</i> 476 . See chapter 7.6.1 "Multifunction input MFI1".
2 - Analog Value MFI2A	Multifunction input 2 is the reference value source (terminal X12.4). Via <i>Operation mode MFI2</i> 562 , the input must be set up as an analog input (voltage or current). See chapter 7.6.2 "Multifunction input MFI2".
3 - Fixed Percentage	The selected fixed percentage is the reference value source. The fixed percentage of the current data set is selected via <i>Fixed percentage value changeover 1</i> 75 and <i>Fixed percentage value changeover 2</i> 76 . See chapter 7.5.2 "Fixed percentages".
4 - Motorpot. via Digital Inputs	Reference value source is the function <i>Percentage motorpoti up</i> 72 and <i>Percentage motorpoti down</i> 73 . See chapter 7.5.3 "Motor potentiometer".
5 - Keypad-Motorpot.	The operator panel is the reference value source, with keys ▲ for increasing the percentage and ▼ for reducing the percentage. Factory setting for <i>Reference percentage source 2</i> 494 . See chapter 7.5.3.4.2 "Control via reference percentage channel".
10 - Repetition Percentage Value	Digital input IN2D (terminal X11.5) which is set as PWM input or the pulse train input are used as the reference value source. PWM input: For parameter <i>Operation mode IN2D</i> 496 , select setting "10 - PWM input 0% – 100%" or "11 - PWM input -100% – 100%". Pulse train input: For parameter <i>Operation mode IN2D</i> 496 , select setting "30 - pulse train". See chapter 7.6.7 "Input PWM/repetition frequency/pulse train".

Reference Percentage Source 1 476 Reference Percentage Source 2 494	Function
20 - Fieldbus Percentage Value	The reference value is transmitted via a bus system. The field bus must write the value in format xxx.xx % into parameter 524 , from which the value is then used.
95 - Obj 0x6071 Target Torque	The torque reference value for torque control is transmitted via CANopen bus system. The signal source contains the value of CANopen object 0x6071. Refer to the communication manual CANopen.
2521 - PLC Output Percentage 1	Percentage output 1 of a PLC-function is the reference value source. See application manual "PLC".
2522 - PLC Output Percentage 2	Percentage output 2 of a PLC-function is the reference value source. See application manual "PLC".

The reference percentage channel can be used in all configurations (parameter *Configuration 30*).

Block diagram

The block diagram shows the reference percentage setting options.

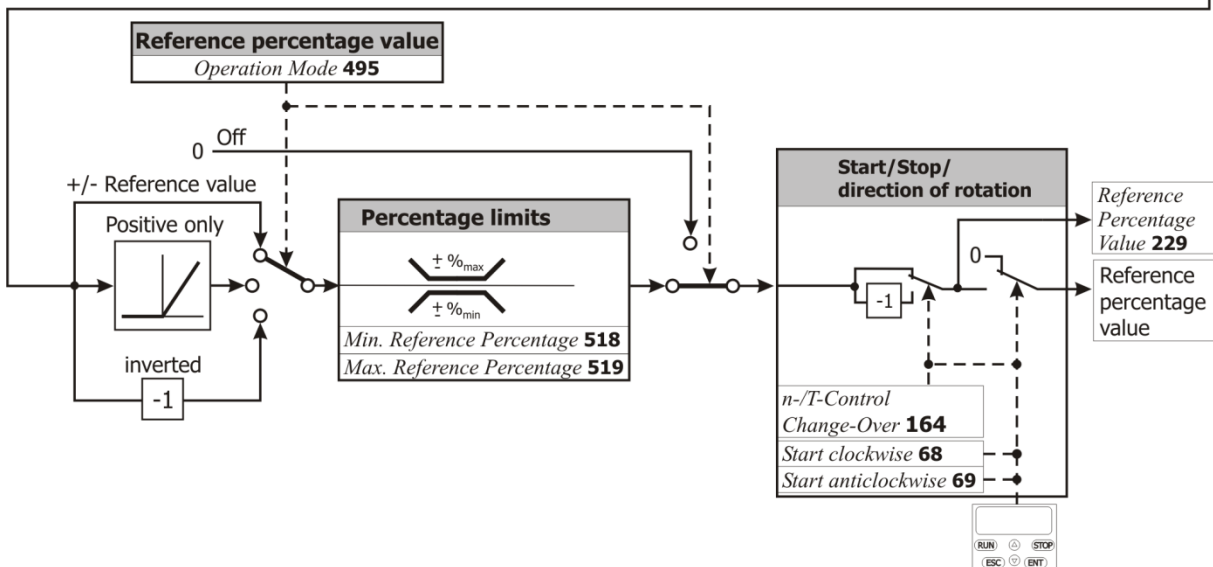
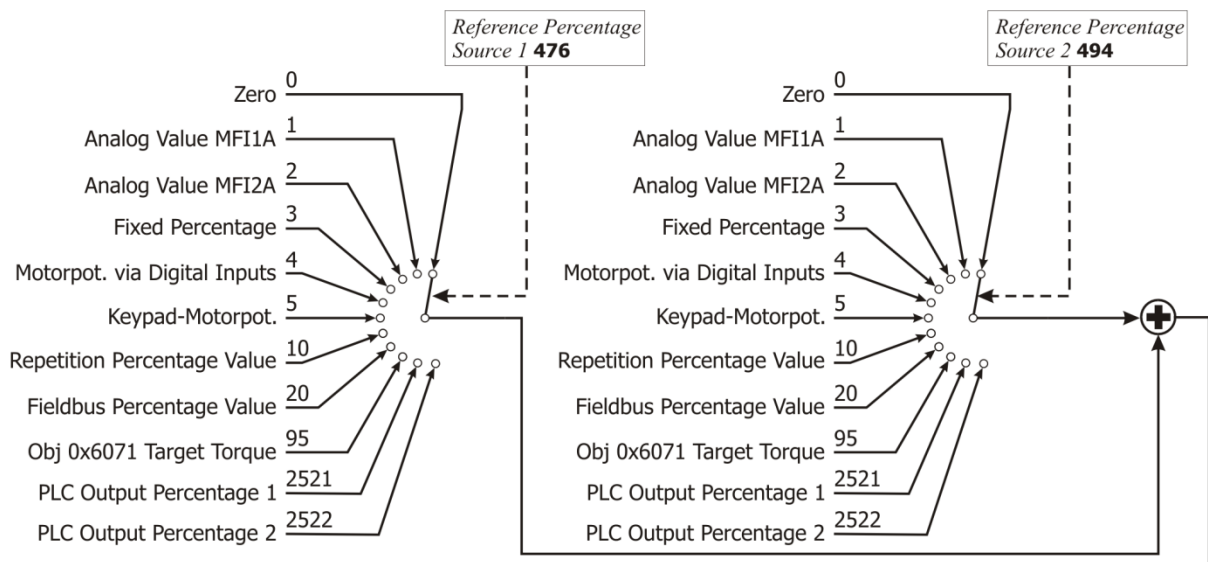

Lock the control possibilities of the control panel

If the setting possibility of the reference percentage at the operator panel must be locked:

- For parameter *Reference Percentage Source 1* **476** the setting "5 - Keypad-Motorpot." must not be selected and
- for parameter *Reference Percentage Source 2* **494** the setting "5 - Keypad-Motorpot." must not be selected.
 - Set parameter *Set Password* **27** to prevent the resetting of parameters. Refer to chapter 7.1.3 "Set password".

NOTE

The setting of Parameter *Set Password* **27** only does not lock the control facilities of the keypad. Start, Stop, Change direction of rotation, Poti F and Poti P are still available.

7.5.2.1 Limits

518 Minimum Reference Percentage

519 Maximum Reference Percentage

The setting range of the percentages is defined by the parameters *Minimum Reference Percentage* **518** and *Maximum Reference Percentage* **519**. The relevant control methods use the two limit values for scaling and calculating the frequency.

Parameters		Setting		
No.	Description	Min.	Max.	Fact. sett.
518	Minimum Reference Percentage	0.00%	300.00%	0.00%
519	Maximum Reference Percentage	0.00%	300.00%	100.00%

7.5.2.2 Positive and negative reference percentages

495 Operation Mode (reference percentage source)

Via parameter *Operation Mode* **495**, you can define if the reference value set via parameters *Reference Percentage Source 1* **476** and *Reference Percentage Source 2* **494** is to be either positive or negative only or if it can be both positive and negative. You can also output the reference percentage as an inverted value (compared to the selected reference value source).

<i>Operation mode 495</i>	Function
0 - Off	Reference percentage channel is switched off. Reference percentage is 0%.
1 - +/- reference value	The reference percentage can be both positive and negative. The values of <i>Reference Percentage Source 1</i> 476 and <i>Reference Percentage Source 2</i> 494 are added up. Factory setting.
2 - Positive only	The reference percentage can only be positive. The reference percentage is limited to the range from 0% to the <i>Maximum Reference Percentage</i> 519 . The values of <i>Reference Percentage Source 1</i> 476 and <i>Reference Percentage Source 2</i> 494 are added up, then the result is limited to positive values.
3 - Inverted	The reference percentage is inverted (compared to the sign of the selected reference value source). The values of <i>Reference Percentage Source 1</i> 476 and <i>Reference Percentage Source 2</i> 494 are added up, then the result is inverted.

The inversion of the reference percentage by means of signal start-anticlockwise or operator panel is only possible if the reference percentage is used as torque reference. Use parameter *n-/T-Control Change-Over* **164** for switching-on the torque control.

7.5.2.3 Fixed percentages

520 Fixed Percentage 1

521 Fixed Percentage 2

522 Fixed Percentage 3

523 Fixed Percentage 4

Via digital logic signals or digital inputs fixed preset reference values can be selected.

The fixed percentages define reference values. Four fixed percentages can be set. The fixed percentages can be selected via *Fixed Percent Change-Over 1* **75** and *Fixed Percent Change-Over 2* **76**. Logic signals or digital inputs must be assigned to the parameters *Fixed Percent Change-Over 1* **75** and *Fixed Percent Change-Over 2* **76**.

Via the reference percentage channel (see chapter 7.5.2 "Reference percentage channel"), the fixed percentages can be selected and linked to other reference value sources. Linking is effected via parameters *Reference Percentage Source 1* **476** and *Reference Percentage Source 2* **494**.

Parameters		Setting		
No.	Description	Min.	Max.	Fact. sett.
520	Fixed Percentage 1	-300.00%	300.00%	0.00%
521	Fixed Percentage 2	-300.00%	300.00%	20.00%
522	Fixed Percentage 3	-300.00%	300.00%	50.00%
523	Fixed Percentage 4	-300.00%	300.00%	100.00%

- Set the required number of fixed percentages (parameters 520 ... 523).
- For fixed percentage changeover (parameters 75, 76, 131), select digital inputs.
- Select fixed percentages with signals at digital inputs.

75 Fixed Percent Change-Over 1

76 Fixed Percent Change-Over 2

By combining the logic states of the fixed percentage changeover modes 1 and 2, fixed percentages 1 through 4 can be selected:

Fixed percentage control		
<i>Fixed Percent Change-Over 1</i> 75	<i>Fixed Percent Change-Over 2</i> 76	Active fixed value
0	0	<i>Fixed Percentage 1</i> 520
1	0	<i>Fixed Percentage 2</i> 521
1	1	<i>Fixed Percentage 3</i> 522
0	1	<i>Fixed Percentage 4</i> 523

0 = contact open 1 = contact closed

Number of digital inputs	Number of fixed percentage values per data set
1	2
2	4

If the data set changeover function is used additionally via parameters *Data Set Change-Over 1* **70** and *Data Set Change-Over 2* **71**, you can preset up to 16 fixed percentages as reference values.

The fixed percentage changeover can also be controlled via digital signals, instead of digital inputs, by functions of the frequency inverter.

Via parameter *Operation Mode* **495**, you can change the direction of rotation of the motor. See chapter 7.5.2.2 "Positive and negative reference percentages". The direction of rotation can also be preset with the digital signal sources assigned to the parameters *Start clockwise* **68** and *Start anti-clockwise* **69**.

Via the reference percentage channel (see chapter 7.5.2 "Reference percentage channel"), the fixed reference values can be selected and linked to other reference value sources.

7.5.2.4 Ramps

477 Gradient Percentage Ramp

The percentage value ramps scale the change of the reference value (in percent) for the corresponding input function. The acceleration and deceleration of the drive are parameterized via the frequency ramps.

The behaviour *Gradient Percentage Ramp 477* corresponds to a function which takes the time behaviour of the drive system into account. If the parameter is set to 0 %/s, this function is deactivated and a direct reference value modification for the following function is obtained.

Parameters		Setting		
No.	Description	Min.	Max.	Fact. sett.
477	Gradient Percentage Ramp	0 %/s	60000 %/s	10 %/s

7.5.3 Motor potentiometer

The reference speed (or the percentage reference value) of the drive can be set via digital control signals or with the operator panel:

- Digital control signals: Function "Motorpoti via digital inputs"
- Operator panel: Function "Keypad motorpoti"

The functions "Motorpoti via digital inputs" and "Keypad motorpoti" can be selected via the following parameters.

Via the reference frequency channel:

- *Reference Frequency Source 1 475*
- *Reference Frequency Source 2 492*

Via the reference percentage channel:

- *Reference Percentage Source 1 476*
- *Reference Percentage Source 2 494*



The functions "Motorpoti via digital inputs" and "Keypad motorpoti" (control via operator panel) can be selected at the same time. To that end, one of the functions must be selected for *Reference Frequency Source 1 475* and the other function for *Reference Frequency Source 2 492*. Then the reference value can be changed by both keypad and digital inputs.

7.5.3.1 Operation modes of motor potentiometer

474 Operation Mode (motorpoti)

Operation Mode 474 of the functions "Motorpoti via digital inputs" and "Keypad motorpoti" defines the behaviour of the function at different operating points of the frequency inverter. When the drive starts, it can accelerate to the last reference value set. Upon dataset changeover, the set reference value can be taken over.

Operation Mode 474	Function
0 - Not Latching	The drive accelerates to the set minimum reference value upon each start. Factory setting.
1 - Latching	When started, the motor accelerates to the reference value selected before the switch-off. The reference value is also stored when the device is switched off.
2 - Taking Over	Use this operation mode for dataset changeover of the reference value channel. The current reference value is used when the motorpoti function is activated.
3 - Taking Over and Latching	This operation mode combines the operation modes 1 and 2.

7.5.3.2 Ramp of motor potentiometer

473 Ramp Frequency-Motorpoti

The speed of the modification of the reference value (ramp) can be set via parameter *Ramp Frequency-Motorpoti* **473**. The ramp is used in the following controls with the reference frequency channel:

- Motorpoti via digital inputs
- Keypad motorpoti (control via operator panel)

Parameters		Setting		
No.	Description	Min.	Max.	Fact. sett.
473	Ramp Frequency-Motorpoti	0.00 Hz/s	999.99 Hz/s	2.00 Hz/s

As a maximum, the acceleration and deceleration of the motorpoti function can only reach the values of the frequency ramps (Parameters 420 to 423), even if *Ramp Frequency-Motorpoti* **473** is set to a higher value.

509 Ramp Percentage-Motorpoti

The speed of the modification of the reference value (ramp) can be set via parameter *Ramp Percentage-Motorpoti* **509**. The ramp is used in the following controls with the reference percentage channel:

- Motorpoti via digital inputs
- Keypad motorpoti (control via operator panel)

Parameters		Setting		
No.	Description	Min.	Max.	Fact. sett.
509	Ramp Percentage-Motorpoti	0.00 %/s	600.00 %/s	10.00 %/s

As a maximum, the speed of the reference value change reaches the value of *Gradient Percentage Ramp* **477**, even if *Ramp Percentage-Motorpoti* **509** is set to a higher value.

7.5.3.3 Motor potentiometer via digital inputs

For the parameterization of the control of the motor potentiometer via digital inputs, it has to be checked if the motor potentiometer is used as frequency reference value or percentage reference value.

7.5.3.3.1 Control via reference frequency channel

62 Frequency Motorpoti Up

63 Frequency Motorpoti Down

The reference frequency of the drive can be set via digital control signals.

Via digital control inputs, the function "Motorpoti up" or "Motorpoti down" is triggered. Logic signals or digital inputs must be assigned to the parameters *Frequency Motorpoti Up* **62** or *Frequency Motorpoti Down* **63**.

- Command "Frequency motorpoti up": The reference frequency increases at the set value of *Ramp Frequency-Motorpoti* **473**.
- Command "Frequency motorpoti down": The reference frequency decreases at the set value of *Ramp Frequency-Motorpoti* **473**.

Motor potentiometer via digital inputs		Function
<i>Frequency Motorpoti Up</i> 62	<i>Frequency Motorpoti Down</i> 63	
0	0	The reference frequency does not change.
1	0	The reference frequency increases at the set ramp.
0	1	The reference frequency decreases at the set ramp.
1	1	The reference frequency is reset to the value of <i>Minimum Frequency</i> 418 . If another reference frequency source is selected via parameter <i>Reference Frequency Source 1</i> 475 or <i>Reference Frequency Source 2</i> 492 , the reference frequency is reset to the value of this source.

0 = contact open 1 = contact closed



WARNING

If a negative reference value is set, the drive is decelerated with command "Frequency motorpoti up". The reference value is changed in positive direction.

Limit

The reference values are limited via the parameters *Minimum Frequency* **418** and *Maximum Frequency* **419**.

Direction of rotation reversal

If parameter *Minimum Frequency* **418** is set to zero, the direction of rotation of the drive can be reversed via the motorpoti function.

"Motorpotentiometer via digital inputs" as reference value

The function "Motorpotentiometer via digital inputs" can be selected via the following parameters:

- *Reference Frequency Source 1* **475**
- *Reference Frequency Source 2* **492**

See chapter 7.5.1 "Reference frequency channel".

Frequency setting using the motorpoti function can be used for adjustable varying speed or for speed control. In the case of a torque control (Parameter *n-/T-Control Change-Over* **164**), this function is switched off and a percentage setting option via the motorpoti function is available.

Chapter 7.6.6.1 "List of control signals" contains a table summarizing the available signal sources for parameters *Frequency Motorpoti Up* **62** and *Frequency Motorpoti Down* **63**.

Addition of reference values

If the reference value of the motorpoti function is added to another reference value, (via *Reference Frequency Source 1* **475** plus *Reference Frequency Source 2* **492**):

- If the value of *Maximum Frequency* **419** is reached and the other reference value is increased, the output value of the motorpoti function is reduced. It is reduced, so that the sum of both reference values is equal to the maximum frequency.
- If the value of *Minimum Frequency* **418** is reached and the other reference value is reduced, the output value of the motorpoti function is increased. It is increased, so that the sum of both reference values is equal to the minimum frequency.
- In the settings for *Operation Mode* **493** = "1 - (+/-reference value)" or "3 - inverted", the point of reversal of direction of rotation can be shifted by the output value of the motorpoti function. The drive changes its direction of rotation if the total of the two reference values changes the sign.

7.5.3.3.2 Control via reference percentage channel

72 Percent Motorpoti Up

73 Percent Motorpoti Down

The reference percentage can be set via digital control signals.

Via digital control inputs, the function "Motorpoti up" or "Motorpoti down" is triggered. Parameters *Percent Motorpoti Up* **72** or *Percent Motorpoti Down* **73** must be assigned logic signals or digital inputs.

- Command "Up": The reference percentage increases at the set value of *Ramp Percentage-Motorpoti* **509**.
- Command "Down": The reference percentage decreases at the set value of *Ramp Percentage-Motorpoti* **509**.

Motor potentiometer via digital inputs		Function
<i>Percent Motorpoti Up</i> 72	<i>Percent Motorpoti Down</i> 73	
0	0	The reference percentage does not change.
1	0	The reference percentage increases at the set ramp.
0	1	The reference percentage decreases at the set ramp.
1	1	The reference percentage is reset to the value of <i>Minimum Reference Percentage</i> 518 . If another reference percentage source is selected via parameter <i>Reference Percentage Source 1</i> 476 or <i>Reference Percentage Source 2</i> 494 , the reference frequency is reset to the value of this source.

0 = contact open 1 = contact closed



WARNING

If a negative reference value is set, the drive is decelerated with command "Percentage motorpoti up". The reference value is changed in positive direction.

Limit

The reference values are limited via parameters *Minimum Reference Percentage* **518** and *Maximum Reference Percentage* **519**.

Direction of rotation reversal

If parameter *Minimum Reference Percentage* **518** is set to zero, the direction of rotation of the drive can be reversed via the motorpoti function.

"Motorpotentiometer via digital inputs" as reference value

The function "Motorpotentiometer via digital inputs" can be selected via the following parameters:

- *Reference Percentage Source 1* **476**
- *Reference Percentage Source 2* **494**

See chapter 7.5.2 "Reference percentage channel".

Chapter 7.6.6.1 "List of control signals" contains a table summarizing the available signal sources for parameters *Percent Motorpoti Up* **72** and *Percent Motorpoti Down* **73**.

Addition of reference values

If the reference value of the motorpoti function is added to another reference value, (via *Reference Percentage Source 1 476* plus *Reference Percentage Source 2 494*):

- If the value of *Maximum Reference Percentage 519* is reached and the other reference value is increased, the output value of the motorpoti function is reduced. It is reduced, so that the sum of both reference values is equal to the maximum reference percentage value.
- If the value of *Minimum Reference Percentage 518* is reached and the other reference value is reduced, the output value of the motorpoti function is increased. It is increased, so that the sum of both reference values is equal to the minimum reference percentage value.
- In the settings for *Operation Mode 495* = "1 - (+/-reference value)" or "3 - inverted", the point of reversal of direction of rotation can be shifted by the output value of the motorpoti function. The drive changes its direction of rotation if the total of the two reference values changes the sign.

7.5.3.4 Keypad motorpoti: Control via operator panel

For the parameterization of the control of the motor potentiometer via operator panel, it has to be checked if the motor potentiometer is used as frequency reference value or percentage reference value.



Depending on the parameter settings and how the function is used, it can happen that the first actuation of the key doesn't cause a visible reaction. In this case the first actuation activates the function.

7.5.3.4.1 Control via reference frequency channel

The reference frequency of the drive can be set via the operator panel in menu "Local"/"Poti F".

The reference frequency is increased or decreased via the arrow buttons.

- Button ▲: The reference frequency increases at the set value of *Ramp Frequency-Motorpoti 473*.
- Button ▼: The reference frequency decreases at the set value of *Ramp Frequency-Motorpoti 473*.
- Button ▲ pressed briefly: The reference frequency is increased by 0.1 Hz each time the button is pressed.
- Button ▼ pressed briefly: The reference frequency is reduced by 0.1 Hz each time the button is pressed.

Press the buttons briefly to fine-tune the reference frequency.

Addressing		
Keypad motor potentiometer	Function	
-	-	The reference frequency does not change.
▲	-	The reference frequency increases at the set ramp. Pressed briefly: Reference frequency increases by 0.1 Hz.
-	▼	The reference frequency decreases at the set ramp. Pressed briefly: Reference frequency decreases by 0.1 Hz.
▲ + ▼		The reference frequency is reset to its initial value.



WARNING
If a negative reference value is set, the drive is accelerated by pressing the button ▼. The reference value is increased in negative direction.

Limit

The reference values are limited via parameters *Minimum Frequency 418* and *Maximum Frequency 419*.

Direction of rotation reversal

If parameter *Minimum Frequency 418* is set to zero, the direction of rotation of the drive can be reversed via the motorpoti function.

NOTICE

In order to be able to select menu "Poti F" on the operator panel, *Reference Frequency Source 1 475* or *Reference Frequency Source 2 492* must be set to "5 - Keypad-Motorpot.". By default, *Reference Frequency Source 2 492* is set to "5 - Keypad-Motorpot.".

Keypad motorpoti as reference value

The function "Keypad motorpoti" can be selected via the following parameters:

- *Reference Frequency Source 1 475*
- *Reference Frequency Source 2 492*

See chapter 7.5.1 "Reference frequency channel".

If you leave menu "Poti F", the drive cannot be controlled via the operator panel and remains in the previous status.

For starting, stopping and reversing the direction of rotation of the drive via the operator panel, parameter *Local/Remote* **412** must be set appropriately (Selection "3 - Control via Keypad" or "4 - Control via Keypad+Cont.>"). The factory settings enable control via the operator panel and via digital inputs. See chapter "7.3 Operational Behaviour".

Frequency setting using the motorpoti function can be used in speed actuated or speed controlled control methods. In the case of a torque control, this function is switched off and a percentage setting option via the motorpoti function is available.

Addition of reference values

If the reference value of the motorpoti function is added to another reference value, (via *Reference Frequency Source 1* **475** plus *Reference Frequency Source 2* **492**):

- If the value of *Maximum Frequency* **419** is reached and the other reference value is increased, the output value of the motorpoti function is reduced. It is reduced, so that the sum of both reference values is equal to the maximum frequency.
- If the value of *Minimum Frequency* **418** is reached and the other reference value is reduced, the output value of the motorpoti function is increased. It is increased, so that the sum of both reference values is equal to the minimum frequency.
- In the settings for *Operation Mode* **493** = "1 - (+/-reference)" or "3 - inverted", the point of reversal of direction of rotation can be shifted by the output value of the motorpoti function. The drive changes its direction of rotation if the total of the two reference values changes the sign.

Lock the control possibilities of the control panel

If drive start and stop and the change of direction of rotation at the operator panel must be locked:

- For parameter *Local/Remote* **412** select a value that is different from 3 or 4.
 - Set parameter *Set Password* **27** to prevent the resetting of the parameter. Refer to chapter 7.1.3 "Set password".

7.5.3.4.2 Control via reference percentage channel

The reference percentage of the drive can be set via the operator panel in menu "Local"/"Poti P".

The reference percentage is increased or decreased via the arrow buttons.

- Button ▲: The reference percentage increases at the set value of *Ramp Percentage-Motorpoti* **509**.
- Button ▼: The reference percentage decreases at the set value of *Ramp Percentage-Motorpoti* **509**.
- Button ▲ pressed briefly: The reference percentage is increased by 0.1% each time the button is pressed.
- Button ▼ pressed briefly: The reference percentage is reduced by 0.1% each time the button is pressed.

Press the buttons briefly to fine-tune the reference percentage.

Addressing		
Keypad motor potentiometer		Function
-	-	The reference percentage does not change.
▲	-	The reference percentage increases at the set ramp. Pressed briefly: Reference percentage increases by 0.1%.
-	▼	The reference percentage decreases at the set ramp. Pressed briefly: Reference percentage decreases by 0.1%.
▲ + ▼		The reference percentage is reset to its initial value.



WARNING

If a negative reference value is set, the drive is accelerated by pressing the button ▼.

Limit

The reference values are limited via parameters *Minimum Reference Percentage* **518** and *Maximum Reference Percentage* **519**.

Direction of rotation reversal

If parameter *Minimum Reference Percentage* **518** is set to zero, the direction of rotation of the drive can be reversed via the motorpoti function.

NOTE

In order to be able to select menu "Poti P" on the operator panel, *Reference Percentage Source 1* **476** or *Reference Percentage Source 2* **494** must be set to "5 - Keypad-Motorpot.". By default, *Reference Percentage Source 2* **494** is set to "5 - Keypad-Motorpot".

Keypad motorpoti as reference value

The function "Keypad motorpoti" can be selected via the following parameters:

- *Reference Percentage Source 1* **476**
- *Reference Percentage Source 2* **494**

See chapter 7.5.2 "Reference percentage channel".

If you leave menu "Poti P", the drive cannot be controlled via the operator panel and remains in the previous status.

For starting, stopping and reversing the direction of rotation of the drive via the operator panel, parameter *Local/Remote* **412** must be set appropriately (Selection "3 - Control via Keypad" or "4 - Control via Keypad+Cont."). The factory settings enable control via the operator panel and via digital inputs. See chapter 7.3.1 "Control".

”.

Addition of reference values

If the reference value of the motorpoti function is added to another reference value, (via *Reference Percentage Source 1* **476** plus *Reference Percentage Source 2* **494**):

- If the value of *Maximum Reference Percentage* **519** is reached and the other reference value is increased, the output value of the motorpoti function is reduced. It is reduced, so that the sum of both reference values is equal to the maximum reference percentage value.
- If the value of *Minimum Reference Percentage* **518** is reached and the other reference value is reduced, the output value of the motorpoti function is increased. It is increased, so that the sum of both reference values is equal to the minimum reference percentage value.
- In the settings for *Operation Mode* **495** = "1 - (+/-reference)" or "3 - inverted", the point of reversal of direction of rotation can be shifted by the output value of the motorpoti function. The drive changes its direction of rotation if the total of the two reference values changes the sign.

Lock the control possibilities of the control panel

If drive start and stop and the change of direction of rotation at the operator panel must be locked:

- For parameter *Local/Remote* **412** select a value that is different from 3 or 4.
 - Set parameter *Set Password* **27** to prevent the resetting of the parameter. Refer to chapter 7.1.3 "Set password".

7.5.4 Electronic gear

Starting the electronic gear: Set one of the following parameters.

Parameters	Factory setting	Set
<i>Reference Frequency Source 1</i> 475	1 - Analog Value MFI1A	40 - el. Gear
or		
<i>Reference Frequency Source 2</i> 492	5 - Keypad-Motorpot.	40 - el. Gear

The electronic gear enables the synchronization of drives without mechanical transmission elements such as shafts or clutches. The reference value for the slave drive is the repetition frequency determined by the master drive. This value can be multiplied by a gear factor. The transmission from the master drive to the slave drive is done via a repetition frequency signal or via system bus.

The gear factor can be set permanently or varied during operation via freely configurable digital and analog signal sources through the percentage reference channel.

125 Source Master Reference

On the slave drive, the reference value for the electronic gear must be selected via parameter *Source Master Reference* **125**. For example, "288 - Repetition Frequency Input" must be selected as the reference value source if the reference value is defined as a repetition frequency via digital input IN2D. In this case, *Operation Mode IN2D* **496** must be set to "20 - RF Single Evaluation" or "21 - RF Double Evaluation" (RF: Repetition Frequency).

If a system bus interface is used, the reference value can be defined via the system bus. Set parameter *Source Master Reference* **125** according to system bus PDO which receives the reference value.

7.5.4.1 Scope of function

- Electronic gear
- Reference value defined via repetition frequency input or system bus
- Gear factor, numerator and denominator can be set separately
- Gear factor can be scaled during the operation
- Offset frequencies can be added depending on digital signals



The system bus transmission of the repetition frequency value from the master drive to the slave drive is effected via the system bus interface at terminals X12.5 and X12.6 or via an optional communication module CM-CAN.

7.5.4.2 Operation modes of electronic gear

689 Operation Mode (electronic gear)

Via parameter *Operation Mode* **689** for the electronic gear, you can determine if the gear factor is to be set permanently or to be scaled via a signal source, e.g. an analog input signal at the slave drive. The repetition frequency of the master drive is multiplied by the gear factor.

Via parameter *Reference Frequency Source 1* **475** or *Reference Frequency Source 2* **492**, the output value of the electronic gear must be selected as the source in the reference frequency channel.

Operation Mode 689	Function
0 - Off	The electronic gear is deactivated. Factory setting.
P. 685 Numerator/P. 686 Denominator	The repetition frequency value specified via the repetition frequency input is multiplied by the gear factor. This is the reference frequency for the slave drive. The gear factor is calculated from the values of parameters <i>Gear Factor Numerator</i> 685 and <i>Gear Factor Denominator</i> 686 .
Analog Numerator/P. 686 Denominator	The repetition frequency value specified via the repetition frequency input is multiplied by the gear factor. This is the reference frequency for the slave drive. The numerator of the gear factor is scaled using the <i>Reference Percentage Source 1</i> 476 . The denominator of the gear factor is the value set in parameter <i>Gear Factor Denominator</i> 686 .
P. 685 Numerator/Analog Denominator	The repetition frequency value specified via the repetition frequency input is multiplied by the gear factor. This is the reference frequency for the slave drive. The numerator of the gear factor is the value set in parameter <i>Gear Factor Numerator</i> 685 . The denominator of the gear factor is scaled using the <i>Reference Percentage Source 1</i> 476 .

Block diagram of electronic gear:

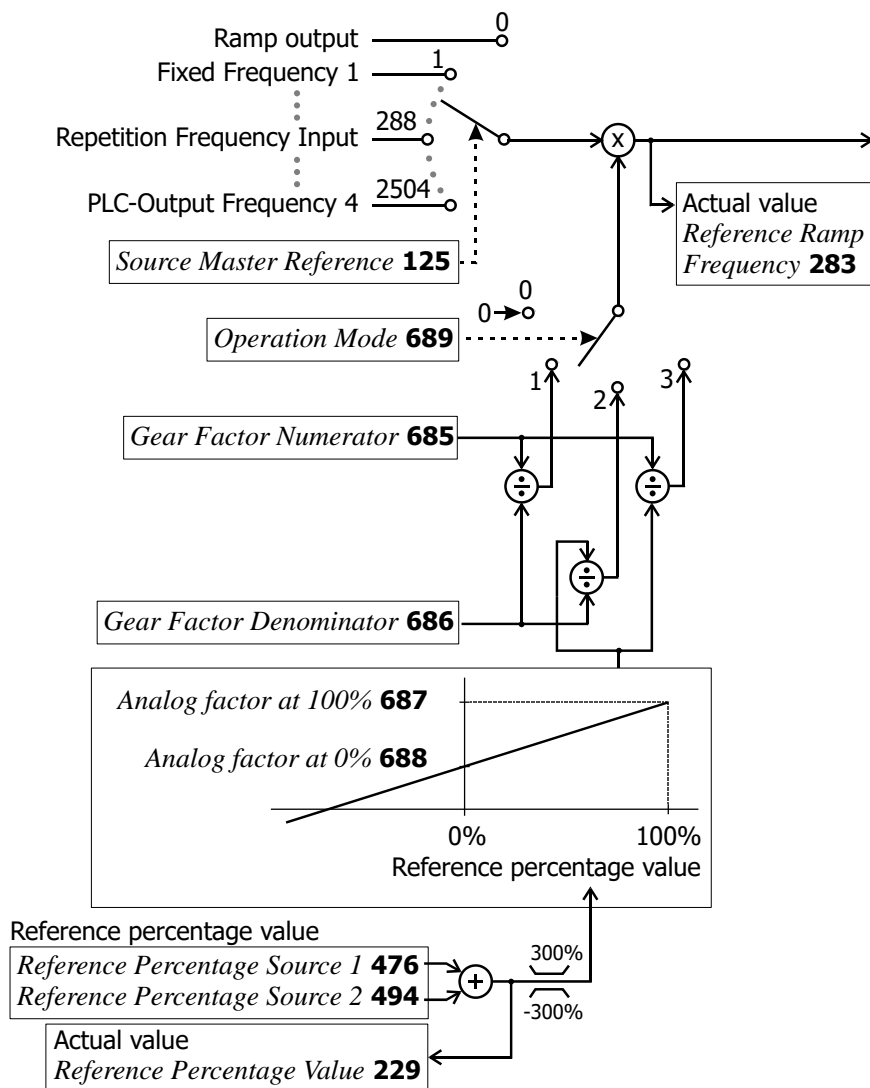

Setting of the reference percentage via parameters *Reference Percentage Source 1* **476** and *Reference Percentage Source 2* **494** is described in chapter 7.5.2 "Reference percentage channel".

7.5.4.3 Gear factor

The gear factor can be set permanently or scaled via the *Reference Percentage Source 476* during operation. Scaling during operation can be effected via an analog voltage signal at a multifunction input. The multifunction input must be set up as an analog input (multifunction input at terminal X12.3: parameter *Operation Mode MF11 452*, multifunction input at terminal X12.4: parameter *Operation Mode MF12 562*).

Setting of the gear factor enables the realization of applications which require an adjustment of the transmission ratio during operations, e.g. winding machines.

7.5.4.3.1 Setting a fixed gear factor

685 Gear Factor Numerator

686 Gear Factor Denominator

Via parameters *Gear Factor Numerator 685* and *Gear Factor Denominator 686*, the gear factor is set permanently at the frequency inverter of the slave drive.

$$\text{Gear factor} = \frac{\text{Gear Factor Numerator } 685}{\text{Gear Factor Denominator } 686}$$

Parameters		Setting		
No.	Description	Min.	Max.	Fact. sett.
685	Gear Factor Numerator	-300.00	300.00	1.00
686	Gear Factor Denominator	0.01	300.00	1.00

7.5.4.3.2 Setting a variable gear factor

687 Analog factor at 100%

688 Analog factor at 0%

With parameters *Analog factor at 100% 687* and *Analog factor at 0% 688*, the range of the gear factor is scaled. For parameter *Operation Mode 689*, setting "2 - (Analog Numerator/P. 686 Denominator)" or "3 - (P. 685 Numerator/Analog Denominator)" must be selected. The scaling is done via the *Reference Percentage Source 1 476* and *Reference Percentage Source 2 494* via which the signal sources for determining the reference value are selected. With the signal source selected, e.g. an analog signal at a multifunction input, the gear factor can be changed during operation.

Parameters		Setting		
No.	Description	Min.	Max.	Fact. sett.
687	Analog factor at 100%	0.00	100.00	1.20
688	Analog factor at 0%	0.00	100.00	0.80

For a block diagram of the electronic gear, refer to chapter 7.5.4.2 "Operation modes of electronic gear".

EXAMPLE:

In an application, a slave drive is to follow a master drive, with the speed of the slave having to be increased continuously without changing the speed specified by the master. The gear factor control is to be done using an analog voltage signal (0...10 V).

Configuration example:

- Via parameter *Operation Mode 689*, set operation mode "2 – (Analog Numerator/P. 686 Denominator)" for the electronic gear for a change of the gear factor by the numerator.
- Set the minimum and maximum limit for the numerator value via parameters *Analog factor at 100% 687* and *Analog factor at 0% 688*.
- Set the *Gear Factor Denominator 686* to the required value.
- Set multifunction input MF11 as an analog voltage input by adjusting *Operation Mode MF11 452* to "1 – Voltage 0...10 V".
- For the *Reference Percentage Source 1 476*, select operation mode "1 - Analog Value MF11A".

In this example, the default settings for *Analog factor at 100%* **687** and *Analog factor at 0%* **688**, an adjusted gear factor denominator of 2 and a reference percentage of 75% will result in a gear factor numerator of 1.1 and a reference frequency for the Slave of $10 \text{ Hz} * 1.1 / 2 = 5.5 \text{ Hz}$.

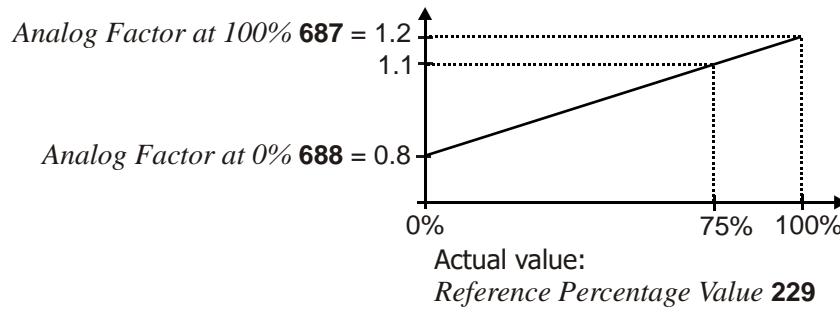

7.5.4.4 Offset

Via the parameters *Reference Frequency Source 2* **492**, you can select frequencies as an offset which are added to the reference frequency.

Adding a fixed frequency to the reference frequency:

- Set parameter *Reference Frequency Source 2* **492** to "3 - Fixed Frequency".
- In one of parameters 480 ... 488 (fixed frequencies) set a frequency value.
- Select the fixed frequency of the set parameter via parameters 66, 67 and 131 (fixed frequency changeover).

See chapter 7.5.1.3 "Fixed frequencies".

".

The frequency for the offset can be set via the operator panel if *Reference Frequency Source 2* **492** is set to "5 - Keypad-Motorpot."

Parameter *Reference Frequency Source 2* **492** offers further options to define the frequency for the offset. See chapter 7.5.1 "Reference frequency channel".

7.5.4.5 Actual values

Via parameter *Repetition Frequency Input* **252**, the reference frequency can be displayed at the repetition frequency input.

Via parameter *Reference Ramp Frequency* **283**, the actual value of the frequency after multiplication by the gear factor and addition of the optionally selectable repetition frequencies can be displayed.

7.5.4.6 Adjustment Options

The following instructions describe options for setting the electronic gear. The settings must be adjusted to the application.



WARNING

The control functions listed in the following table may affect the synchronous operation of the drives. It should be checked if these additional control functions are switched on and if they are required.

Parameters		Function
573	Operation mode	Intelligent current limits
610	Operation mode	Current limit value controller
660	Operation mode	Slip compensation
670	Operation mode	Voltage controller
164	n/T Control change over	Switch over Torque control
475	Reference Frequency Source 1	Added reference frequency value
492	Reference Frequency Source 2	

Via parameter *Controller Status* **275**, you can display if a controller is active.

The function of the electronic gear is realized by configuring digital inputs of the slave frequency inverter as a reference frequency input. If the master drive is a frequency inverter, the repetition frequency output of the master frequency inverter is used.

7.5.4.6.1 Frequency inverter as master drive

If the master drive of the electronic gear is a frequency inverter, the following parameters (for example) can be set for the transmission of the repetition frequency.

- Select operation mode "20 – Repetition Frequency MFO1F" for parameter *Operation Mode MFO1 (X13.6)* **550**. As a result, the multifunction output is used as a repetition frequency output.
- Via parameter *RF/PT: Output Value MFO1F* **555**, select an operation mode for multifunction output 1.
- Set the value entered for parameter *RF: Division Marks* **556** according to the frequency required at the repetition frequency output. This is the number of pulses per motor revolution for the repetition frequency. The pulse duration depends on the motor speed. By default, this parameter is set to 1024. When making the settings, take the frequency limit of the frequency output of 150 kHz into account. The maximum value S_{\max} which can be set for parameter *RF: Division Marks* **556** is:

$$S_{\max} = \frac{150\,000 \text{ Hz}}{\text{Frequency value}}$$

7.5.4.6.2 Frequency inverter as slave drive

For the function of the electronic gear via the repetition frequency, the following parameters (for example) can be set at the frequency inverter of the Slave drive.

- For parameter *Operation Mode IN2D* **496** select: "20 - RF Single Evaluation" or "21 - RF Double Evaluation" (RF: Repetition Frequency). Digital input IN2D is the repetition frequency input. See chapter 7.6.7.2 "Repetition frequency input".
- Since the rated speed decreases when the number of pole pairs is higher ($n \sim 1/p$), different speeds may result if the master drive and slave drive have the same reference frequencies. Adjust the values for parameters *Divider* **497** of the repetition frequency input of the slave drive and *RF: Division marks* **556** of the repetition frequency output of the master according to the number of pole pairs of the motors in order to obtain the same speeds for the master drive and the slave drive. Different speeds can be realized by setting the gear factor.

Different values for parameters *Rep. Freq: Divider* **497** of the repetition frequency input of the slave drive and *RF: Division Marks* **556** of the repetition frequency output of the master result in different speeds of the master drive and the slave drive if the number of pole pairs of the motors is the same.

- Set parameters *Acceleration (Clockwise)* **420** and *Deceleration (Clockwise)* **421** or *Acceleration Anticlockwise* **422** and *Deceleration Anticlockwise* **423** to the required values. For synchronous acceleration and deceleration of the drives, set the values of the slave drive slightly higher (in example 10 %) than the values of the master drive. These increased values are to ensure that the slave drive can follow the master drive in dynamic operation cases.
- For a synchronous start of the master drive and the slave drive, set the *Minimum Frequency* **418** of the slave drive to 0 in order to prevent an early start of the slave drive if the controller enable signal is present.
- Select an *Operation Mode* **689**. Via parameters *Gear Factor Numerator* **685** and *Gear Factor Denominator* **686**, set the required transmission ratio.



WARNING

In order to avoid time delays during the processing of the repetition frequency, the slave frequency inverter should be enabled before the master frequency inverter.

WARNING



The reference frequency is transmitted, but not the direction of rotation. In this case, the direction of rotation must be defined via the digital inputs IN1D and IN2D at the slave drive.

7.6 Control inputs and outputs

The control inputs and outputs can be parameterized freely. All hardware inputs and outputs are preset to frequently used functions by default for simple commissioning.

7.6.1 Multifunction input MFI1

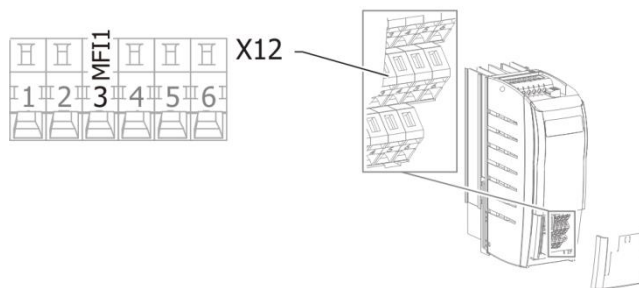

452 Operation Mode MFI1 (Multifunction input 1)

Multifunction input MFI1 can be configured as a voltage, current or a digital input. In the configuration as a digital input, the evaluation can be selected as PNP (high-switching) or NPN (low-switching).

Depending on the selected *Operation Mode MFI1 452*, various functions of the frequency inverter can be controlled.

<i>Operation Mode MFI1 452</i>	Function
1 - Voltage 0...10V	Voltage signal (MFI1A), 0 V ... 10 V. Fixed characteristic. Factory setting.
2 - Current 0...20 mA	Current signal (MFI1A), 0 mA ...20 mA. Fixed characteristic.
3 - Digital NPN (active: 0 V)	Digital signal (MFI1D) 0 V ... 24 V. Low-switching (with negative signal).
4 - Digital PNP (active: 24 V)	Digital signal (MFI1D) 0 V ... 24 V. High-switching (with positive signal).
5 - Current 4...20 mA	Current signal (MFI1A), 4 mA ...20 mA. Fixed characteristic.
6 - Voltage, characteristic	Voltage signal (MFI1A), 0 V ... 10 V. The output signal is influenced by the set characteristic. The characteristic can be set via parameters 454 ... 457.
7 - Current, characteristic	Current signal (MFI1A) 0 mA ... 20 mA. The output signal is influenced by the set characteristic. The characteristic can be set via parameters 454 ... 457.

Multifunction input MFI1 is configured by default for an analog reference value source with a voltage signal of 0 V to 10 V.

Alternatively, you can select the operation mode for an analog current signal of 0 ... 20 mA or 4 ... 20 mA. The current signal is continuously monitored and the fault message "F1407" displayed if the maximum figure is exceeded.

7.6.1.1 Multifunction input set as analog input MFI1A

The Multifunction input can be evaluated either as analogue or digital signal. In the following the evaluation for analogue signals is described.

7.6.1.1.1 Voltage input and current input

For parameter *Operation Mode MFII 452*, "1 - Voltage 0...10V", "2 - Current 0...20 mA" or "5 - Current 4...20 mA" must be selected.

<i>Operation Mode MFII 452</i>	Function
1 - Voltage 0...10 V	Voltage signal (MFI1A), 0 V ... 10 V. Fixed characteristic. Factory setting.
2 - Current 0...20 mA	Current signal (MFI1A), 0 mA ...20 mA. Fixed characteristic.
4 - Current 4...20 mA	Current signal (MFI1A), 4 mA ...20 mA. Fixed characteristic.

The analog input signal is mapped to a reference frequency or percentage.

VOLTAGE 0...10 V

Parameter *Operation Mode MFII 452* is set to "1 - Voltage 0...10 V". The coordinates of the points relate, as a percentage, to the analog signal with 9.8 V and parameter *Maximum Frequency 419* or parameter *Maximum Reference Percentage 519*. The zero-crossing of the frequency or the percentage value lies at 0.2 V. The deviations from 10 V and 0 V allow the operation even with voltage supplies that have small deviations from the nominal values.

Inclination:

$$\frac{9.8 \text{ V} - 0.2 \text{ V}}{\text{Maximum reference value}} \hat{=} \frac{9.6 \text{ V}}{\text{Maximum Frequency 419}} \hat{=} \frac{9.6 \text{ V}}{\text{Maximum Perc. 519}}$$

CURRENT 0...20 MA

Parameter *Operation Mode MFII 452* must be set to "2 - Current 0...20 mA". The coordinates of the points relate, as a percentage, to the analog signal with 19.6 mA and parameter *Maximum Frequency 419* or parameter *Maximum Reference Percentage 519*. The zero-crossing of the frequency or the percentage value lies at 0.4 mA. The deviations from 20 mA and 0 mA allow the operation even with voltage supplies that have small deviations from the nominal values.

Inclination:

$$\frac{19.6 \text{ mA} - 0.4 \text{ mA}}{\text{Maximum reference value}} \hat{=} \frac{19.2 \text{ mA}}{\text{Maximum Frequency 419}} \hat{=} \frac{19.2 \text{ mA}}{\text{Maximum Perc. 519}}$$

CURRENT 4...20 MA

Parameter *Operation Mode MFII 452* must be set to "5 - Current 4...20 mA". The coordinates of the points relate, as a percentage, to the analog signal with 19.6 mA and parameter *Maximum Frequency 419* or parameter *Maximum Reference Percentage 519*. The zero-crossing of the frequency or the percentage value lies at 4.4 mA. The deviations from 20 mA and 4 mA allow the operation even with voltage supplies that have small deviations from the nominal values.

Inclination:

$$\frac{19.6 \text{ mA} - 4.4 \text{ mA}}{\text{Maximum reference value}} \hat{=} \frac{15.2 \text{ mA}}{\text{Maximum Frequency 419}} \hat{=} \frac{15.2 \text{ mA}}{\text{Maximum Perc. 519}}$$

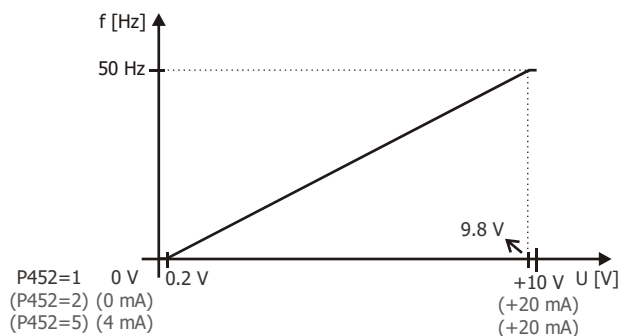

7.6.1.1.2 Voltage input characteristic and current input characteristic

For parameter *Operation Mode MFII 452*, "6 - Voltage, characteristic" or "7 - Current, characteristic" must be selected.

<i>Operation Mode MFII 452</i>	Function
6 - Voltage, characteristic	Voltage signal (MFI1A), 0 V ... 10 V. The output signal is influenced by the set characteristic. The characteristic can be set via parameters 454 ... 457.
7 - Current, characteristic	Current signal (MFI1A) 0 mA ... 20 mA. The output signal is influenced by the set characteristic. The characteristic can be set via parameters 454 ... 457.

454 Characteristic Curve Point X1

455 Characteristic Curve Point Y1

456 Characteristic Curve Point X2

457 Characteristic Curve Point Y2

The analog input signal is mapped to a reference frequency or percentage. Parameterization can be done via two points of the linear characteristic of the reference value channel.

Point 1 with coordinates X1 and Y1 and point 2 with coordinates X2 and Y2 can be set in four data sets.

Parameters		Setting		
No.	Description	Min.	Max.	Fact. sett.
454	Characteristic Curve Point X1	0.00%	100.00%	2.00%
455	Characteristic Curve Point Y1	-100.00%	100.00%	0.00%
456	Characteristic Curve Point X2	0.00%	100.00%	98.00%
457	Characteristic Curve Point Y2	-100.00%	100.00%	100.00%

The coordinates of the points relate, as a percentage, to the analog signal with 10 V or 20 mA and parameter *Maximum Frequency 419* or parameter *Maximum Reference Percentage 519*. The direction of rotation can be changed via the digital inputs and/or by selection of the points.

WARNING



ATTENTION!

The monitoring of the analog input signal via the parameter *Error/Warning Behaviour 453* demands the check of parameter *Characteristic Curve Point X1 454*.

In the settings

- "6 - Voltage, characteristic" or
- "7 - Current, characteristic"

of parameter *Operation Mode MF11 452*, the following characteristic is effective:

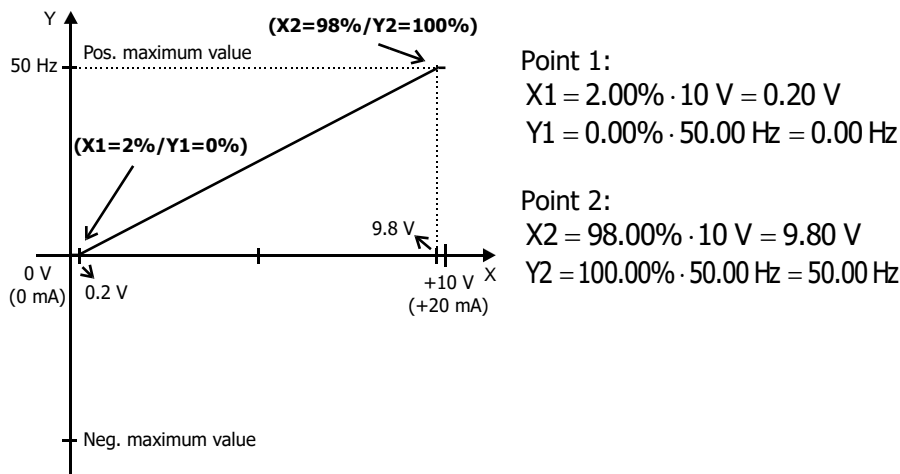

The characteristic can be adjusted via parameters 454 ... 457 of the application.

The freely configurable characteristic enables setting a tolerance at the ends as well as a reversal of the direction of rotation.

The following example shows the inverse reference value specification with additional reversal of the direction of rotation. This is often used in pressure control systems.

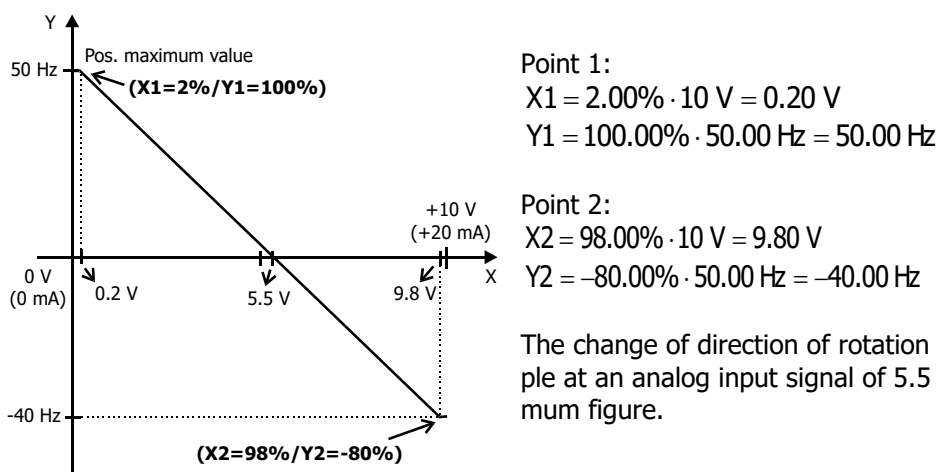

The change of direction of rotation is done in this example at an analog input signal of 5.5 V. pos./neg. maximum figure.

The definition of the analog input characteristic can be calculated via the two-point form of the line equation. The speed Y of the drive is controlled according to the analog control signal X.

$$Y = \frac{Y2 - Y1}{X2 - X1} \cdot (X - X1) + Y1$$

Scaling

The analog input signal is mapped to the freely configurable characteristic. The maximum admissible setting range of the drive can be set via the frequency limits or percentage limits. In the case of the parameterization of a bipolar characteristic, the set minimum and maximum limits for both directions of rotation are effective. The percentage values of the characteristic points are relative to the limits selected.

Parameters		Setting		
No.	Description	Min.	Max.	Fact. sett.
418	Minimum Frequency	0.00 Hz	599.00 Hz	3.50 Hz
419	Maximum Frequency	0.00 Hz	599.00 Hz	50.00 Hz

The control system uses the maximum value of the output frequency, which is calculated from the *Maximum Frequency 419* and the compensated slip of the drive mechanism. The frequency limits define the speed range of the drive, and the percentage values supplement the scaling of the analog input characteristic in accordance with the functions configured.

Parameters		Setting		
No.	Description	Min.	Max.	Fact. sett.
518	Minimum Reference Percentage	0.00%	300.00%	0.00%
519	Maximum Reference Percentage	0.00%	300.00%	100.00%

450 Tolerance Band

The analog input characteristic with change of sign of the reference value can be adapted by the parameter *Tolerance Band 450* of the application. The adjustable tolerance band extends the zero passage of the speed relative to the analog control signal. The parameter value (percent) is relative to the maximum current or voltage signal.

Parameters		Setting		
No.	Description	Min.	Max.	Fact. sett.
450	Tolerance Band	0.00%	25.00%	2.00%

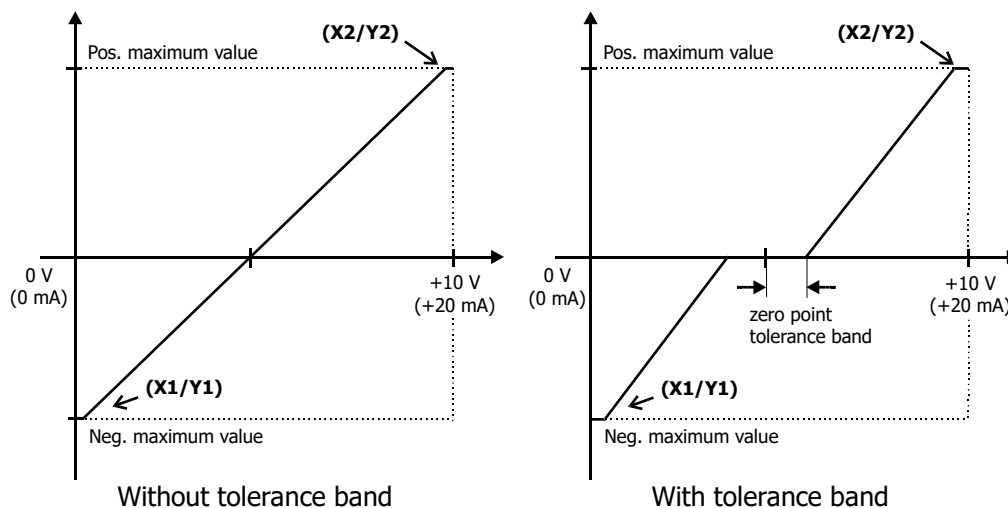

Hysteresis

The default *Minimum Frequency 418* or *Minimum Reference Percentage 518* extends the parameterized tolerance band to the hysteresis.

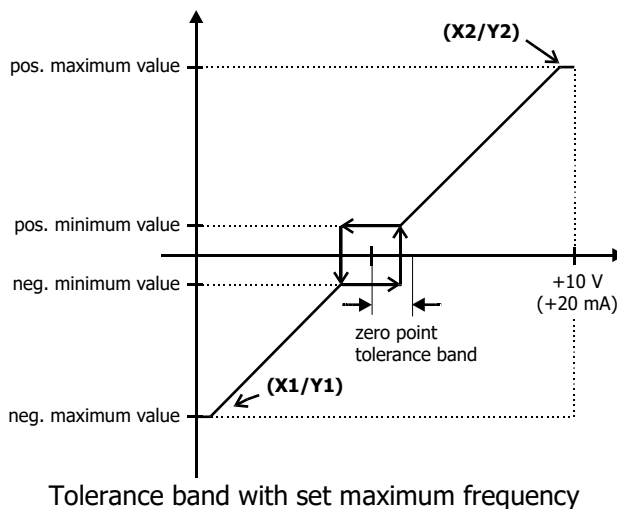

For example, the output variable coming from positive input signals is kept on the positive minimum value until the input signal becomes lower than the value for the tolerance band in the negative direction. Then, the output variable follows the set characteristic.

7.6.1.1.3 Monitoring of analog input signal

451 Filter time constant

The time constant of the filter for the analog reference value can be set via the parameter *Filter time constant* **451**. The time constant indicates the time during which the input signal is averaged by means of a low pass filter, in example in order to eliminate fault effects.

The setting range is between 0 ms and 5000 ms in 15 steps.

<i>Filter time constant 451</i>	Function
0 - Time constant 0 ms	Filter deactivated – The analog reference value is forwarded unfiltered.
2 - Time constant 2 ms	
4 - Time constant 4 ms	
8 - Time constant 8 ms	
16 - Time constant 16 ms	
32 - Time constant 32 ms	
64 - Time constant 64 ms	
128 - Time constant 128 ms	
256 - Time constant 256 ms	
512 - Time constant 512 ms	
1000 - Time constant 1000 ms	
2000 - Time constant 2000 ms	
3000 - Time constant 3000 ms	
4000 - Time constant 4000 ms	
5000 - Time constant 5000 ms	

453 Error/Warning Behaviour

For monitoring the analog input signal, an operation mode can be selected via parameter *Error/Warning Behaviour* **453**.

<i>Error/Warning Behaviour 453</i>	Function
0 - Off	The input signal is not monitored. Factory setting.
1 - Warning < 1V/2 mA	If the input signal is lower than 1 V or 2 mA, a warning message is issued.
2 - Shutdown < 1V/2 mA	If the input signal is lower than 1 V or 2 mA, a warning and fault message is issued. The drive is decelerated according to stopping behaviour 2.
3 - Error-Switch-Off < 1V/2 mA	If the input signal is lower than 1 V or 2 mA, a warning and fault message is issued and the drive coasts to a standstill (stopping behaviour 0).

Monitoring of the analog input signal is active regardless of the enable of the frequency inverter.

Operation mode 2 defines the shut-down and stopping of the drive, regardless of the setting of parameter *Operation Mode* **630** for the stopping behaviour. The drive is stopped according to stopping behaviour 2. If the set holding time has expired, an error message is issued. The drive can be started again by switching the start signal on and off.

Operation mode 3 defines the free coasting of the drive (as described in stopping behaviour 0), regardless of the setting of parameter *Operation Mode* **630** for the stopping behaviour.

WARNING



ATTENTION!

The monitoring of the analog input signal via the parameter *Error/Warning Behaviour 453* demands the check of parameter *Characteristic Curve Point X1 454*.

Example: *Error/Warning Behaviour 453* = "2 - Shutdown < 1V/2mA" or "3 - Error Switch-Off < 1V/2mA". In the factory settings of the parameter *Characteristic Curve Point X1 454* shutting down or error switch-off are affected at an output frequency \neq 0 Hz. If shutting down or error switch-off are to be effected at an output frequency of 0 Hz, the Point X1 must be adjusted (e.g. X1=10% /1 V).

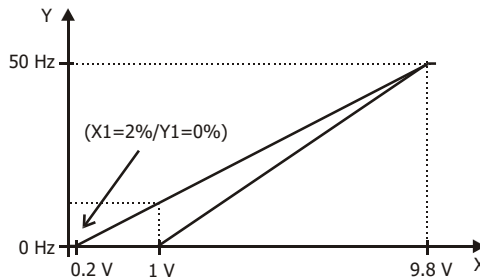

7.6.1.2 Multifunction input set as digital input MFI1D

Multifunction input MFI1 (terminal X12.3) can be configured as a digital input. Via parameter *Operation Mode MFII 452*, the evaluation can be selected as PNP (high-switching) or NPN (low-switching).

The multifunction input set as digital input can be linked to the functions of the frequency inverter. Signal "76 - MFI1D" must be assigned a function.

<i>Operation Mode MFII 452</i>	Function
3 - Digital NPN (active: 0 V)	Digital signal (MFI1D) 0 V ... 24 V. Low-switching (with negative signal).
4 - Digital PNP (active: 24 V)	Digital signal (MFI1D) 0 V ... 24 V. High-switching (with positive signal).

Signal source	Function
76 - MFI1D	Assign to a function, e.g. select signal source for parameter.

7.6.2 Multifunction input MFI2

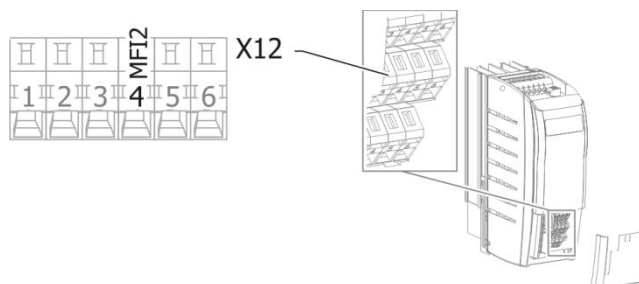

562 Operation Mode MFI2 (Multifunction input 2)

Multifunction input MFI2 can be configured as a voltage, current or a digital input. In the configuration as a digital input, the evaluation can be selected as PNP (high-switching) or NPN (low-switching).

Depending on the selected *Operation Mode MFI2 562*, various functions of the frequency inverter can be controlled.

<i>Operation Mode MFI2 562</i>	Function
1 - Voltage 0...10 V	Voltage signal (MFI2A), 0 V ... 10 V. Fixed characteristic.
2 - Current 0...20 mA	Current signal (MFI2A), 0 mA ... 20 mA. Fixed characteristic.
3 - Digital NPN (active: 0 V)	Digital signal (MFI2D) 0 V ... 24 V. Low-switching (with negative signal). Factory setting.
4 - Digital PNP (active: 24 V)	Digital signal (MFI2D) 0 V ... 24 V. High-switching (with positive signal).
5 - Current 4...20 mA	Current signal (MFI2A), 4 mA ... 20 mA. Fixed characteristic
6 - Voltage, characteristic	Voltage signal (MFI2A), 0 V ... 10 V. The output signal is influenced by the set characteristic. The characteristic can be set via parameters 564 ... 567.
7 - Current, characteristic	Current signal (MFI2A) 0 mA ... 20 mA. The output signal is influenced by the set characteristic. The characteristic can be set via parameters 564 ... 567.

By default, multifunction input MFI2 is set as a digital input for connection of a motor thermal contact. Alternatively, you can select the operation mode for an analog voltage or current signal. The current signal is continuously monitored and the fault message "F1407" displayed if the maximum figure is exceeded.

7.6.2.1 Multifunction input set as analog input MFI2A

The Multifunction input can be evaluated either as analogue or digital signal. In the following the evaluation for analogue signals is described.

7.6.2.1.1 Voltage input and current input

For parameter *Operation Mode MFI2 562*, "1 - Voltage 0...10 V", "2 - Current 0...20 mA" or "5 - Current 4...20 mA" must be selected.

<i>Operation Mode MFI2 562</i>	Function
1 - Voltage 0...10 V	Voltage signal (MFI2A), 0 V ... 10 V. Fixed characteristic.
2 - Current 0...20 mA	Current signal (MFI2A), 0 mA ... 20 mA. Fixed characteristic.
5 - Current 4...20 mA	Current signal (MFI2A), 4 mA ... 20 mA. Fixed characteristic

The analog input signal is mapped to a reference frequency or percentage.

The analog input signal is mapped to a reference frequency or percentage.

VOLTAGE 0...10 V

Parameter *Operation Mode MFI2 562* is set to "1 - Voltage 0...10 V". The coordinates of the points relate, as a percentage, to the analog signal with 9.8 V and parameter *Maximum Frequency 419* or parameter *Maximum Reference Percentage 519*. The zero-crossing of the frequency or the percentage value lies at 0.2 V. The deviations from 10 V and 0 V allow the operation even with voltage supplies that have small deviations from the nominal values.

Inclination:

$$\frac{9.8\text{ V} - 0.2\text{ V}}{\text{Maximum reference value}} \hat{=} \frac{9.6\text{ V}}{\text{Maximum Frequency 419}} \hat{=} \frac{9.6\text{ V}}{\text{Maximum Perc. 519}}$$

CURRENT 0...20 MA

Parameter *Operation Mode MFI2 562* must be set to "2 - Current 0...20 mA". The coordinates of the points relate, as a percentage, to the analog signal with 19.6 mA and parameter *Maximum Frequency 419* or parameter *Maximum Reference Percentage 519*. The zero-crossing of the frequency or the percentage value lies at 0.4 mA. The deviations from 20 mA and 0 mA allow the operation even with voltage supplies that have small deviations from the nominal values.

Inclination:

$$\frac{19.6\text{ mA} - 0.4\text{ mA}}{\text{Maximum reference value}} \hat{=} \frac{19.2\text{ mA}}{\text{Maximum Frequency 419}} \hat{=} \frac{19.2\text{ mA}}{\text{Maximum Perc. 519}}$$

CURRENT 4...20 MA

Parameter *Operation Mode MF11 452* must be set to "5 - Current 4...20 mA". The coordinates of the points relate, as a percentage, to the analog signal with 19.6 mA and parameter *Maximum Frequency 419* or parameter *Maximum Reference Percentage 519*. The zero-crossing of the frequency or the percentage value lies at 4.4 mA. The deviations from 20 mA and 4 mA allow the operation even with voltage supplies that have small deviations from the nominal values.

Inclination:

$$\frac{19.6 \text{ mA} - 4.4 \text{ mA}}{\text{Maximum reference value}} \cong \frac{15.2 \text{ mA}}{\text{Maximum Frequency 419}} \cong \frac{15.2 \text{ mA}}{\text{Maximum Perc. 519}}$$

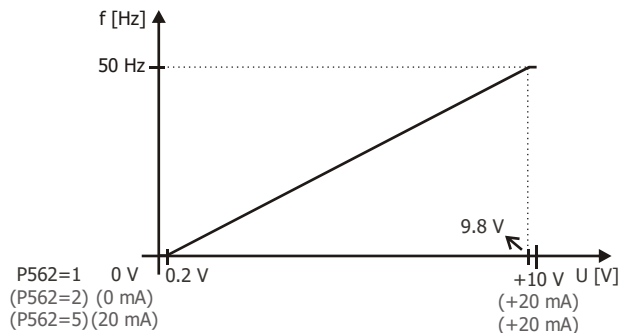

7.6.2.1.2 Voltage input characteristic and current input characteristic

For parameter *Operation Mode MF12 562*, "6 - Voltage, characteristic" or "7 - Current, characteristic" must be selected.

<i>Operation Mode MF12 562</i>	Function
6 - Voltage, characteristic	Voltage signal (MF12A), 0 V ... 10 V. The output signal is influenced by the set characteristic. The characteristic can be set via parameters 564 ... 567.
7 - Current, characteristic	Current signal (MF12A) 0 mA ... 20 mA. The output signal is influenced by the set characteristic. The characteristic can be set via parameters 564 ... 567.

564 Characteristic Curve Point X1

565 Characteristic Curve Point Y1

566 Characteristic Curve Point X2

567 Characteristic Curve Point Y2

The analog input signal is mapped to a reference frequency or percentage. Parameterization can be done via two points of the linear characteristic of the reference value channel.

Point 1 with coordinates X1 and Y1 and point 2 with coordinates X2 and Y2 can be set in four data sets.

Parameters		Setting		
No.	Description	Min.	Max.	Fact. sett.
564	Characteristic Curve Point X1	0.00%	100.00%	2.00%
565	Characteristic Curve Point Y1	-100.00%	100.00%	0.00%
566	Characteristic Curve Point X2	0.00%	100.00%	98.00%
567	Characteristic Curve Point Y2	-100.00%	100.00%	100.00%

The coordinates of the points relate, as a percentage, to the analog signal with 10 V or 20 mA and parameter *Maximum Frequency 419* or parameter *Maximum Reference Percentage 519*. The direction of rotation can be changed via the digital inputs and/or by selection of the points.

WARNING



The monitoring of the analog input signal via the parameter *Error/Warning Behaviour* **563** demands the check of parameter *Characteristic Curve Point X1* **564**.

In the settings

- "6 - Voltage, characteristic" or
- "7 - Current, characteristic"

of parameter *Operation Mode MFII* **452**, the following characteristic is effective:

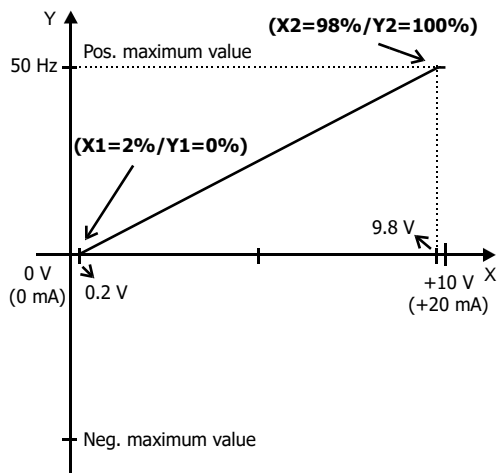

Point 1:

$$X1 = 2.00\% \cdot 10 \text{ V} = 0.20 \text{ V}$$

$$Y1 = 0.00\% \cdot 50.00 \text{ Hz} = 0.00 \text{ Hz}$$

Point 2:

$$X2 = 98.00\% \cdot 10 \text{ V} = 9.80 \text{ V}$$

$$Y2 = 100.00\% \cdot 50.00 \text{ Hz} = 50.00 \text{ Hz}$$

The characteristic can be adjusted via parameters 564 ... 567 of the application.

The freely configurable characteristic enables setting a tolerance at the ends as well as a reversal of the direction of rotation.

The following example shows the inverse reference value specification with additional reversal of the direction of rotation. This is often used in pressure control systems.

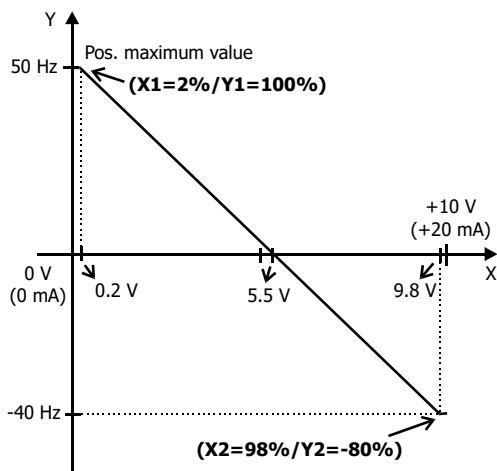

Point 1:

$$X1 = 2.00\% \cdot 10 \text{ V} = 0.20 \text{ V}$$

$$Y1 = 100.00\% \cdot 50.00 \text{ Hz} = 50.00 \text{ Hz}$$

Point 2:

$$X2 = 98.00\% \cdot 10 \text{ V} = 9.80 \text{ V}$$

$$Y2 = -80.00\% \cdot 50.00 \text{ Hz} = -40.00 \text{ Hz}$$

The change of direction of rotation is done in this example at an analog input signal of 5.5 V. pos./neg. maximum figure

The definition of the analog input characteristic can be calculated via the two-point form of the line equation. The speed Y of the drive is controlled according to the analog control signal X.

$$Y = \frac{Y2 - Y1}{X2 - X1} \cdot (X - X1) + Y1$$

Scaling

The analog input signal is mapped to the freely configurable characteristic. The maximum admissible setting range of the drive can be set via the frequency limits or percentage limits. In the case of the parameterization of a bipolar characteristic, the set minimum and maximum limits for both directions of rotation are effective. The percentage values of the characteristic points are relative to the limits selected.

Parameters		Setting		
No.	Description	Min.	Max.	Fact. sett.
418	Minimum Frequency	0.00 Hz	599.00 Hz	3.50 Hz
419	Maximum Frequency	0.00 Hz	599.00 Hz	50.00 Hz

The control system uses the maximum value of the output frequency, which is calculated from the *Maximum Frequency 419* and the compensated slip of the drive mechanism. The frequency limits define the speed range of the drive. The percentage limits complement the scaling of the analog input characteristic according to the configured functions.

Parameters		Setting		
No.	Description	Min.	Max.	Fact. sett.
518	Minimum Reference Percentage	0.00%	300.00%	0.00%
519	Maximum Reference Percentage	0.00%	300.00%	100.00%

560 Tolerance Band

The analog input characteristic with change of sign of the reference value can be adapted by the parameter *Tolerance Band 560* of the application. The adjustable tolerance band extends the zero passage of the speed relative to the analog control signal. The parameter value (percent) is relative to the maximum current or voltage signal.

Parameters		Setting		
No.	Description	Min.	Max.	Fact. sett.
560	Tolerance Band	0.00%	25.00%	2.00%

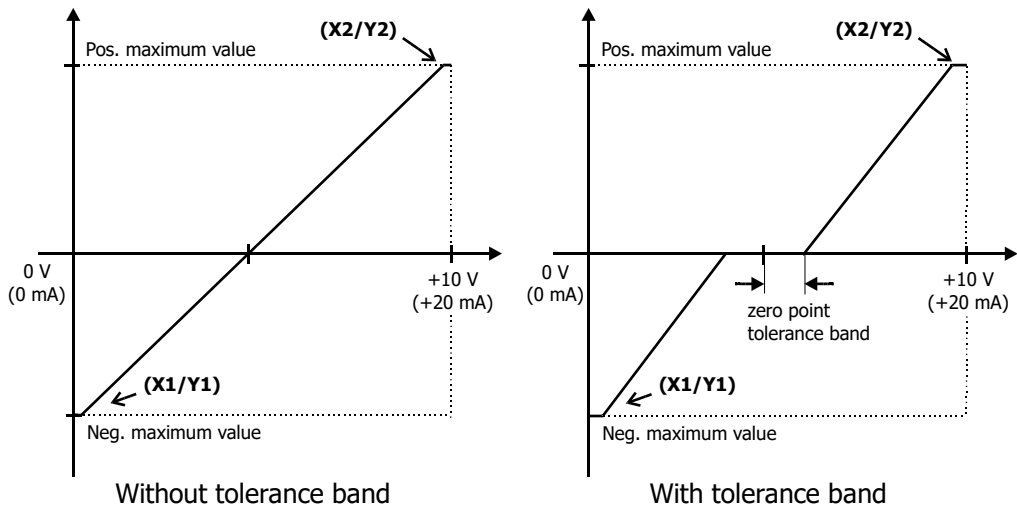

The default *Minimum Frequency 418* or *Minimum Reference Percentage 518* extends the parameterized tolerance band to the hysteresis.

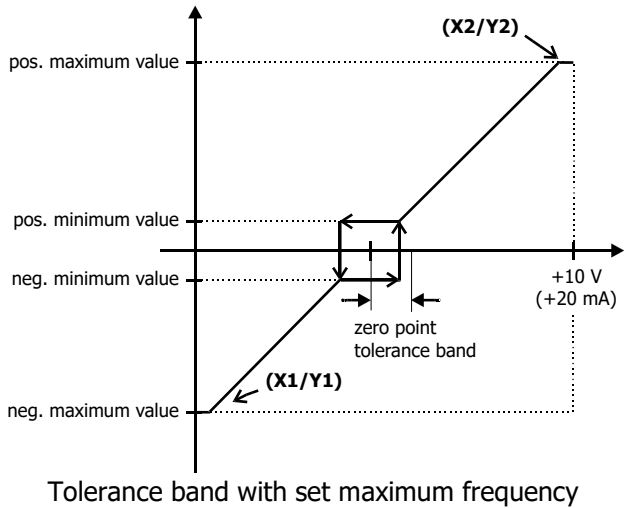

For example, the output variable coming from positive input signals is kept on the positive minimum value until the input signal becomes lower than the value for the tolerance band in the negative direction. Then, the output variable follows the set characteristic.

7.6.2.1.3 Monitoring of analog input signal

561 Filter time constant

The time constant of the filter for the analog reference value can be set via the parameter *Filter time constant* **561**. The time constant indicates the time during which the input signal is averaged by means of a low pass filter, e.g. in order to eliminate fault effects.

The setting range is between 0 ms and 5000 ms in 15 steps.

<i>Filter time constant 561</i>	Function
0 - Time constant 0 ms	Filter deactivated – The analog reference value is forwarded unfiltered.
2 - Time constant 2 ms	
4 - Time constant 4 ms	
8 - Time constant 8 ms	
16 - Time constant 16 ms	
32 - Time constant 32 ms	
64 - Time constant 64 ms	
128 - Time constant 128 ms	
256 - Time constant 256 ms	
512 - Time constant 512 ms	
1000 - Time constant 1000 ms	
2000 - Time constant 2000 ms	
3000 - Time constant 3000 ms	
4000 - Time constant 4000 ms	
5000 - Time constant 5000 ms	

563 Error/Warning Behaviour

For monitoring the analog input signal, an operation mode can be selected via parameter *Error/Warning Behaviour* **563**.

<i>Error/Warning Behaviour 563</i>	Function
0 - Off	The input signal is not monitored. Factory setting.
1 - Warning < 1V/2 mA	If the input signal is lower than 1 V or 2 mA, a warning message is issued.
2 - Shutdown < 1V/2 mA	If the input signal is lower than 1 V or 2 mA, a warning and fault message is issued. The drive is decelerated according to stopping behaviour 2.
3 - Error-Switch-Off < 1V/2 mA	If the input signal is lower than 1 V or 2 mA, a warning and fault message is issued and the drive coasts to a standstill (stopping behaviour 0).

Monitoring of the analog input signal is active regardless of the enable of the frequency inverter.

Operation mode 2 defines the shut-down and stopping of the drive, regardless of the setting of parameter *Operation Mode* **630** for the stopping behaviour. The drive is stopped according to stopping behaviour 2. If the set holding time has expired, an error message is issued. The drive can be started again by switching the start signal on and off.

Operation mode 3 defines the free coasting of the drive (as described in stopping behaviour 0), regardless of the setting of parameter *Operation Mode* **630** for the stopping behaviour.

! WARNING



The monitoring of the analog input signal via the parameter *Error/Warning Behaviour 563* demands the check of parameter *Characteristic Curve Point X1 564*.

Example: *Error/warning behaviour 563* = "2 - Shutdown < 1V/2mA" or "3 - Error-Switch-Off < 1V/2mA". In the factory settings of the parameter *Characteristic Curve Point X1 564* shutting down or error switch-off are affected at an output frequency \neq 0 Hz. If shutting down or error switch-off are to be effected at an output frequency of 0 Hz, the Point X1 must be adjusted (e.g. X1=10% /1 V).

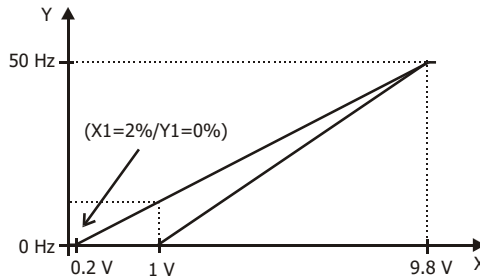

7.6.2.2 Multifunction input set as digital input MFI2D

Multifunction input MFI2 (terminal X12.4) can be configured as a digital input. Via parameter *Operation Mode MFI2 562*, the evaluation can be selected as PNP (high-switching) or NPN (low-switching).

The multifunction input set as digital input can be linked to the functions of the frequency inverter. Signal "77 - MFI2D" must be assigned a function.

In the factory settings, signal "532 - MFI2D (Hardware)" is assigned to parameter *Thermal contact for P570 204*.

<i>Operation Mode MFI2 562</i>	Function
3 - Digital NPN (active: 0 V)	Digital signal (MFI2D) 0 V ... 24 V. Low-switching (with negative signal). Factory setting.
4 - Digital PNP (active: 24 V)	Digital signal (MFI2D) 0 V ... 24 V. High-switching (with positive signal).

Signal source	Function
532 - MFI2D (Hardware)	Assign to a function, e.g. select signal source for parameter. Factory setting: <i>Thermal contact for P570 204</i> = "532 - MFI2D (Hardware)".
77 - MFI2D	Assign to a function, e.g. select signal source for parameter.

7.6.3 Multifunction output MFO1

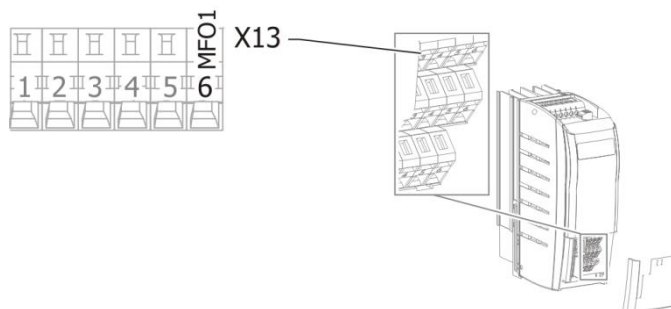

550 Operation Mode MFO1 (X13.6) (multifunction output)

Multifunction output MFO1 (terminal X13.6) can either be configured as a digital, analog, repetition frequency or pulse train output. Depending on the selected *Operation Mode MFO1 (X13.6) 550*, a connection with various functions of the software is possible. The operation modes not used are deactivated internally.

<i>Operation mode MFO1 (X13.6) 550</i>	Function
0 - Off	Multifunction output has logic signal LOW.
1 - Digital MFO1D	Multifunction output is configured as digital output (0 ... 24 V ¹⁾).
10 - Analog (PWM) MFO1A	Multifunction output is configured as analog output (0 ... 24 V). PWM frequency = 126 Hz. Function available in devices without integrated Functional Safety.
11 - Analog (PWM) MFO1A	Multifunction output is configured as analog output (0 ... 24 V). Factory setting. PWM frequency = 32 kHz.
20 - Repetition frequency (RF) MFO1F	Multifunction output is configured as repetition frequency output (0 ... 24 V, $f_{max} = 150$ kHz).
30 - Pulse train (PT) MFO1F	Multifunction output is configured as pulse train output.

¹⁾ Dependent on the voltage supply of the control unit. The maximum guaranteed value is 15 V.

Output characteristic (analog mode)

If the multifunction output is set as an analog output, an output characteristic can be set. Parameter *Operation Mode MFO1 (X13.6) 550* must be set to "11 - Analog (PWM) MFO1A" (factory setting).

551 Analog: Voltage 100%

552 Analog: Voltage 0%

The voltage range of the output signal at the multifunction output can be adjusted. The value range of the actual value selected via parameter *Analog: Source MFO1A 553* is assigned to the value range of the output signal which is adjusted via the parameters *Analog: Voltage 100% 551* and *Analog: Voltage 0% 552*.

Parameters		Setting		
No.	Description	Min.	Max.	Fact. sett.
551	Analog: Voltage 100%	0.0 V	22.0 V	10.0 V
552	Analog: Voltage 0%	0.0 V	22.0 V	0.0 V

Analog: Source MFO1A **553** with actual absolute value:

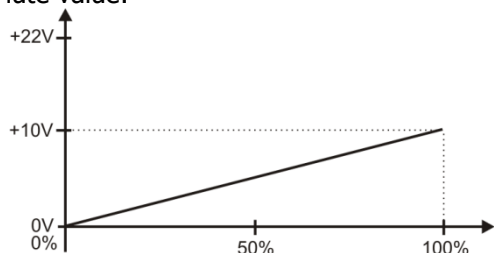

Analog: Source MFO1A **553** with sign:

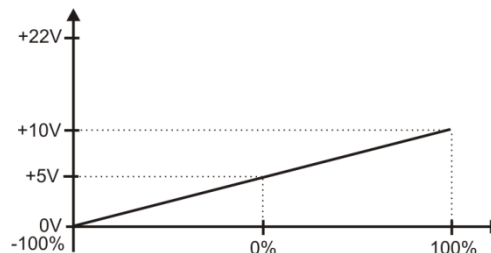

With the parameters *Analog: Voltage 100%* **551** and *Analog: Voltage 0%* **552**, the voltage range at 100% and 0% of the output parameter is set. If the output value exceeds the reference value, the output voltage also exceeds the value of the parameter *Analog: Voltage 100%* **551** up to the maximum value of 22 V (or the maximum value of an external voltage supply).

NOTICE

IF OPERATION MODE MFO1 (X13.6) **550** = 11- ANALOG (PWM) MFO1A AND PARAMETER S ANALOG: VOLTAGE 100% **551** < ANALOG: VOLTAGE 0% **552**, THEN THE SMALLER VOLTAGE VALUE OF ANALOG: VOLTAGE 100% **551** IS PUT OUT.

553 Analog: Source MFO1A

If the multifunction output is to be used as analog output, parameter *Operation Mode MFO1 (X13.6)* **550** must be set to "11 - Analog (PWM) MFO1A".

For parameter *Analog: Source MFO1A* **553**, the analog actual value to be output at the multifunction output can be selected.

Parameters	Factory setting	Set
<i>Operation mode MFO1 (X13.6)</i> 550	11 - Analog (PWM) MFO1A	11 - Analog (PWM) MFO1A
<i>Analog: Source MFO1A</i> 553	7 - Abs. Actual Frequency	Select an analog signal source.

<i>Analog: Source MFO1A</i> 553	Function
0 - Off	Analog mode at the multifunction output is switched off.
1 - Abs. Fs	Abs. value of the stator frequency. 0.00 Hz ... <i>Maximum Frequency</i> 419 .
2 - Abs. Fs betw. fmin/fmax	Abs. value of the stator frequency. <i>Minimum Frequency</i> 418 ... <i>Maximum Frequency</i> 419 .
7 - Abs. Actual Frequency	Abs. value of act. frequency. 0.00 Hz ... <i>Maximum Frequency</i> 419 . Factory setting .
10 - Abs. Reference Percentage	Absolute value of reference value from reference percentage channel. Total of <i>Reference Percentage Source 1</i> 476 and <i>Reference Percentage Source 2</i> 494 .
11 - Abs. Ref. Percentage betw. %min/%max	Absolute value of reference value from reference percentage channel. <i>Minimum Reference Percentage</i> 518 ... <i>Maximum Reference Percentage</i> 519 . Total of <i>Reference Percentage Source 1</i> 476 and <i>Reference Percentage Source 2</i> 494 .
20 - Abs. Iactive	Abs. value of current effective current I_{Active} . 0.0 A ... Nominal frequency inverter current.
21 - Abs. Isd	Abs. value of flux-forming current component. 0.0 A ... Nominal frequency inverter current.
22 - Abs. Isq	Abs. value of torque-forming current component. 0.0 A ... Nominal frequency inverter current.
30 - Abs. Pactive	Abs. value of current effective power P_{Active} . 0.0 kW ... <i>Rated Mech. Power</i> 376 .
31 - Abs. T	Abs. value of calculated torque M, 0.0 Nm ... rated torque.

<i>Analog: Source MFO1A 553</i>	Function
32 - Abs. Inside Temperature	Abs. value of measured inside temperature. -20 °C ... 100 °C.
33 - Abs. Heat Sink Temperature	Abs. value of measured heat sink temperature. -20 °C ... 100 °C.
34 - Abs. Capacitor temperature	Abs. value of measured capacitor temperature. -20 °C ... 100 °C.
40 - Abs. Analog Input MFI1A	Abs. signal value at analog input MFI1A. DC 0.0 V ... 10.0 V.
41 - Abs. Analog Input MFI2A	Abs. signal value at analog input MFI2A. DC 0.0 V ... 10.0 V.
50 - Abs. I	Abs. current value of measured output currents. 0.0 A ... Nominal frequency inverter current.
51 - DC-Link Voltage	DC-link voltage U_d . DC 0.0 V ... 1000.0 V.
52 - V	Output voltage. 3xAC 0.0 V ... 1000.0 V.
61 - Abs. Val. PLC-Output Percentage 1	Output value "2521 – PLC Output Percentage 1" of a PLC-function is output via the multifunction output. Refer to application manual "PLC".
62 - Abs. Val. PLC-Output Percentage 2	Output value "2522 – PLC Output Percentage 2" of a PLC-function is output via the multifunction output. Refer to application manual "PLC".
101 to 162	Operation modes in analog operation with signs.

By default, the multifunction output is configured for the output of a pulse width modulated output signal with a reference voltage value of DC 10 V.

554 Digital: Source MFO1D

If the multifunction output is to be used as a digital output, parameter *Operation Mode MFO1 (X13.6) 550* must be set to "1 - Digital MFO1D".

For parameter *Digital: Source MFO1D 554*, the signal to be output at the multifunction output can be selected.

Parameters	Factory setting	Set
<i>Operation mode MFO1 (X13.6) 550</i>	11 - Analog (PWM) MFO1A	1 - Digital MFO1D
<i>Digital: Source MFO1D 554</i>	4 - Setting frequency (Refer to 7.6.5.2 "Setting frequency".)	Select a digital signal source. (Refer to 7.6.5 "Digital outputs", table "Operation modes for digital outputs".)

555 RF/PT: Output Value MFO1F(repetition frequency/pulse train)

Multifunction output MFO1 can be used as a frequency output. Parameter *Operation Mode MFO1 (X13.6) 550* must be set to "20 - Repetition Frequency (RF) MFO1F". The output signal can be selected via parameter *RF/PT: Output Value MFO1F 555*.

Parameters	Factory setting	Set
<i>Operation mode MFO1 (X13.6) 550</i>	11 - Analog (PWM) MFO1A	20 - Repetition Frequency (RF) MFO1F

<i>RF/PT: Output Value MFO1F 555</i>	Function
0 - Off	Repetition frequency mode switched off.
1 - Actual Frequency	Abs. value of the <i>Actual frequency 241</i> . Factory setting.
2 - Stator Frequency	Abs. value of the <i>Stator frequency 210</i> .
5 - Repetition Frequency Input	Abs. value of the <i>Repetition frequency input 252</i> .

The maximum frequency value output is:

$$f_{\text{outp. max}} = 2 \times (\text{Maximum Frequency } \mathbf{419}) \times (\text{RF : Division marks } \mathbf{556})$$

Scaling

If the multifunction output is set as a frequency output, the output frequency can be scaled. Parameter *Operation Mode MFO1 (X13.6) 550* must be set to "20 - Repetition frequency (RF) MFO1F".

556 RF: Division marks (repetition frequency mode)

The repetition frequency mode for the multifunction output corresponds to the emulation of an incremental sensor. The parameter *RF: Division marks 556* must be parameterized according to the frequency to be output.

Parameters		Setting		
No.	Description	Min.	Max.	Fact. sett.
556	RF: Division marks	30	8192	1024

The frequency limit of $f_{\text{max}} = 150$ kHz may not be exceeded in the calculation of the parameter *RF: Division marks 556*.

$$S_{\text{max}} = \frac{150000 \text{ Hz}}{\text{Reference frequency value}}$$

Pulse train output

A pulse train signal (pulse sequence) can be output as a master frequency.

If the multifunction output is to be used as a pulse train output, parameter *Operation Mode MFO1 (X13.6) 550* must be set to "30 - Pulse Train (PT) MFO1F".

Parameters	Factory setting	Set
<i>Operation mode MFO1 (X13.6) 550</i>	11 - Analog (PWM) MFO1A	30 - Pulse Train (PT) MFO1F

557 PT: Scaling Frequency (pulse train)

Parameter *PT: Scaling Frequency 557* indicates which frequency the multifunction output outputs at 100% maximum frequency. Thus, the scaling also depends on the setting of parameter *Maximum frequency 419*.

Parameters		Setting		
No.	Description	Min.	Max.	Fact. sett.
557	PT: Scaling Frequency	0	32000	25000

If parameter *PT: Scaling Frequency 557* is set to zero, the frequency value at the multifunction output will not be scaled.

The output value is limited to the value $2 \times \text{Maximum Frequency } \mathbf{419}$.

Example: Reference value 50 Hz, *Maximum Frequency 419* = 100 Hz

<i>PT: Scaling Frequency 557</i>	Output frequency [Hz]
0	50
1	0.5
10	5
100	50
1000	500

Example: Reference value 25 Hz, *Maximum Frequency 419* = 50 Hz

<i>PT: Scaling Frequency 557</i>	Output frequency [Hz]
0	25
1000	500

7.6.4 Digital input/output IN3D/OUT3D

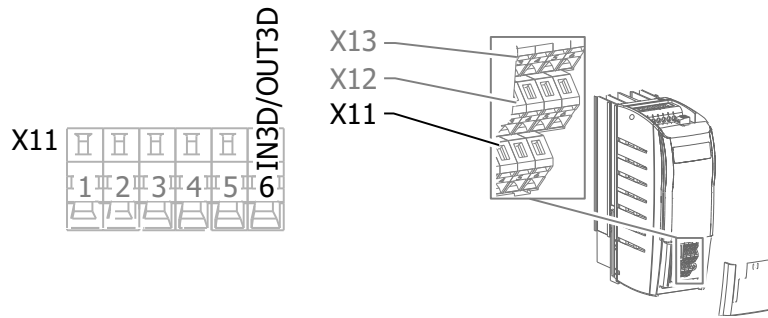

558 Operation mode terminal X11.6 (digital input/output)

Terminal X11.6 can be set as a digital input or digital output. In the factory setting, terminal X11.6 can be used as input for dataset changeover.

Operation mode terminal X11.6 558	Function
0 - Input IN3D	The digital input/output is set as digital input. Factory setting.
1 - Output OUT3D	The digital input/output is set as digital output.

559 Digital inputs PNP/NPN

If the digital input output (terminal X11.6) is set as digital input, the evaluation can be selected as PNP (high-switching) or NPN (low-switching) via parameter *Digital inputs PNP/NPN* 559. Parameter *Operation Mode Terminal X11.6* 558 must be set to "0 - Input IN3D".

Digital inputs PNP/NPN 559	Function
0 - NPN (active: 0 V)	Digital input NPN. Low-switching (with negative signal).
1 - PNP (active: 24 V)	Digital input PNP. High-switching (with positive signal). Factory setting.



The parameter also effect the NPN/PNP evaluation change-over of IN1D, IN2D, IN4D and IN5D.

The digital input IN3D can control functions of the frequency inverter via signal "73 - IN3D". In the factory setting, digital input IN3D has the function "Dataset changeover 1" if *Operation Mode Terminal X11.6* 558 is set to "0 - input IN3D".

Parameters	Factory setting
<i>Data Set Change-Over 1</i> 70	73 - IN3D (input signal at digital input IN3D)

The signal selected via parameter *Operation Mode OUT3D (X11.6)* 533, is output at the digital input/output (terminal X11.6). Parameter *Operation Mode Terminal X11.6* 558 must be set to "1 - Output OUT3D".

Parameter	Factory setting
<i>Operation Mode OUT3D (X11.6)</i> 533	103 - Inv. Error Signal

7.6.5 Digital outputs

531 Operation Mode *OUT1D* (X13.5) (Digital output)

532 Operation Mode *OUT2D* (X10/relay)

533 Operation Mode *OUT3D* (X11.6) (Digital input/output)

554 Digital: Source *MFO1D* (Multifunction output)

The digital signals listed in table "Operation modes for digital outputs" can be output via:

- Digital output
- Multifunction output (set as digital output)
- Digital input/output (set as digital output)
- Relay output

If the multifunction output or digital input/output is to output a digital value, the relevant output must be set up as a digital output:

Output	Terminal	Parameters	Factory setting	Set
Multifunction output	X13.6	Operation Mode <i>MFO1</i> (X13.6) 550	11 - Analog (PWM) <i>MFO1A</i>	1 - Digital <i>MFO1D</i>
Digital input/output	X11.6	Operation Mode Terminal X11.6 558	0 - Input <i>IN3D</i>	1 - Output <i>OUT3D</i>

Factory settings of digital outputs

Output	Terminal	Parameters	Factory setting
Digital output	X13.5	Operation Mode <i>OUT1D</i> (X13.5) 531	2 - Run signal
Multifunction output	X13.6	Digital: Source <i>MFO1D</i> 554	4 - Setting frequency
Digital input/output	X11.6	Operation Mode <i>OUT3D</i> (X11.6) 533	103 - Inv. error signal
Relay output	X10	Operation Mode <i>OUT2D</i> (X10/relay) 532	103 - Inv. error signal

NOTICE

The relay output at terminal X10 is switched off if the communication between control and power circuitry of the frequency inverter is faulty. This avoids dangerous conditions for example in the brake control of hoist applications.

Operation modes for digital outputs

Operation mode 531, 532, 533, 554	Function
0 - Off	Digital output is switched off
1 - Ready or Standby Signal	Frequency inverter is initialized and on stand-by or in operation
2 - Run Signal	Enable signals <i>STOA</i> and <i>STOB</i> and a start command are present, output frequency available.
3 - Error Signal	The message is displayed via parameter <i>Actual error</i> 259 .
4 - Setting Frequency	The <i>Stator frequency</i> 210 is higher than the parameterized <i>Setting frequency</i> 510 . See chapter 7.6.5.2 "Setting frequency".
5 - Reference Frequency reached	The <i>Actual frequency</i> 241 of the drive has reached the <i>Internal reference frequency</i> 228 . See chapter 7.6.5.3 "Reference value reached".
6 - Reference Percentage reached	The <i>Actual percentage</i> 230 has reached the <i>Reference percentage</i> 229 . See chapter 7.6.5.3 "Reference value reached".

Operation mode 531, 532, 533, 554	Function
7 - Ixt warning	The <i>Warning limit short-term Ixt</i> 405 or <i>Warning Limit Long-Term Ixt</i> 406 is reached.
8 - Warning Heat Sink Temperature	Max. heat sink temperature T_K minus the <i>Warning limit heat sink temp.</i> 407 reached.
9 - Warning Inside Temperature	Maximum inside temperature T_K minus the <i>Warning limit inside temp.</i> 408 reached.
10 - Warning Motor Temperature	Warning according to configured <i>Operation mode motor temp.</i> 570 and <i>Max. motor winding temp.</i> 617 .
11 - Warning, General	The message is displayed via parameter <i>Warnings</i> 269 .
12 - Warning Overtemperature	The selected limit values <i>Warning limit heat sink temp.</i> 407 , <i>Warning limit inside temp.</i> 408 or the maximum motor temperature have been exceeded.
13 - Mains Failure	Failure of the mains voltage and power regulation active according to <i>Operation Mode</i> 670 for the voltage controller.
14 - Warning Motor Protect. Switch	Parameterized <i>Operation Mode</i> 571 for the motor circuit breaker triggered.
15 - Warning Current Limitation	A controller or the <i>Operation Mode</i> 573 of the intelligent current limits limit the output current. See chapter 7.6.5.6 "Current limitation".
16 - Controller Current Limit. Long Term Ixt	The overload reserve for 60 s has been used up and the output current is being limited. See chapter 7.6.5.6 "Current limitation".
17 - Controller Current Limit. Short Term Ixt	The overload reserve for 1 s has been used up and the output current is being limited. See chapter 7.6.5.6 "Current limitation".
18 - Controller Current Limit. Tc	Max. heat sink temperature T_K reached, intelligent current limits of <i>Operation Mode</i> 573 active. See chapter 7.6.5.6 "Current limitation".
19 - Controller Current Limit. Motor Temp.	Maximum motor temperature reached, intelligent current limits of <i>Operation Mode</i> 573 active. See chapter 7.6.5.6 "Current limitation".
22 - Warning V-Belt	Warning of <i>Operation mode</i> 581 of V-belt monitoring
25 - Warning Mask	Message of the configurable parameter <i>Create warning mask</i> 536 . See chapter 7.6.5.8 "Warning mask".
26 - Warning, Application	A warning application is signaled. Display of the actual value is effected via parameter <i>Application Warnings</i> 273 . See chapter 7.6.5.9 "Warning mask, application".
27 - Warning Mask, Application	Message of the configurable parameter <i>Create warning mask application</i> 626 .
28 - Warning, gen + Warning, Application	A warning or warning application is signalled.
29 - Warn. Mask, gen + Warn. Mask, Appl.	Message of configurable parameters <i>Create warning mask</i> 536 and <i>Create Warning Mask Application</i> 626 .
30 - Flux-Forming finished	Magnetic field has been impressed. See chapter 7.6.5.4 "Flux forming finished".
31 - Handshake Traverse Function	Signal of the traverse function. See chapter 7.10.8 "Traverse function".
41 - Brake release	Activation of a brake unit depending on the <i>Operation Mode</i> 620 for the starting behaviour, <i>Operation Mode</i> 630 for the stopping behaviour or the configured brake control system. See chapter 7.6.5.5 "Release brake".
43 - External fan	The <i>Switch-on temperature</i> 39 has been reached. An external fan can be switched on by the signal. See chapter 7.6.5.7 "External fan".
50 - Warning service fan	The time remaining until service has expired. See chapter 10.3.2 "Fan".

Operation mode 531, 532, 533, 554	Function
51 - Warning service DC-link	The time remaining until service has expired. See chapter 10.3.1 "DC-link".
80 - PLC-Output Buffer 1	Output signal of a PLC function. Signal source "2401 - PLC output buffer 1" is the output signal. The assignment is performed via parameter <i>PLC-target output 1</i> 1350 or <i>PLC-target output 2</i> 1351 .
81 - PLC-Output Buffer 2	Output signal of a PLC function. Signal source "2402 - PLC output buffer 2" is the output signal. In a table function the assignment is performed via parameter <i>PLC-target output 1</i> 1350 or <i>PLC-target output 2</i> 1351 .
82 - PLC-Output Buffer 3	Output signal of a PLC function. Signal source "2403 - PLC output buffer 3" is the output signal. In a table function the assignment is performed via parameter <i>PLC-target output 1</i> 1350 or <i>PLC-target output 2</i> 1351 .
83 - PLC-Output Buffer 4	Output signal of a PLC function. Signal source "2404 - PLC output buffer 4" is the output signal. In a table function the assignment is performed via parameter <i>PLC-target output 1</i> 1350 or <i>PLC-target output 2</i> 1351 .
90 to 94 Obj 0x3003 DigOut 1 to Obj 0x3003 DigOut 5	Sources of CAN objects.
100 to 194	Operation modes inverted (LOW active).

7.6.5.1 Digital message

Signals output via a digital output can be linked to a function of the frequency inverter. The signals selected for the following parameters can be linked to functions:

- Operation mode *OUT1D* (X13.5) **531** (digital output)
- Operation mode *OUT2D* (X10/relay) **532**
- Operation mode *OUT3D* (X11.6) **533** (digital input/output)
- Digital: Source *MFO1D* **554** (multifunction output)

Signal at digital output *OUT1D*

175 -	Digital message <i>OUT1D</i>	Signal selected via <i>Operation Mode OUT1D</i> (X13.5) 531 .
-------	------------------------------	----------------------------------------------------------------------

Signal at digital output *OUT2D* (relay output)

176 -	Digital message <i>OUT2D</i> relay	Signal selected via <i>Operation Mode OUT2D</i> (X10/relay) 532 .
-------	------------------------------------	--------------------------------------------------------------------------

Signal at digital input/output (terminal X11.6)

177 -	Digital message <i>OUT3D</i>	Signal selected via <i>Operation Mode OUT3D</i> (X11.6) 533 . Set: <i>Operation Mode Terminal X11.6</i> 558 = "1 - Output <i>OUT3D</i> ".
-------	------------------------------	---------------------------------------------------------------------------------------------------------------------------------------------------------

Signal at multifunction output

181 -	Digital message <i>MFO1D</i>	Signal selected via <i>Digital: Source MFO1D</i> 554 . Set: <i>Operation Mode MFO1</i> (X13.6) 550 = "1 - Digital <i>MFO1D</i> ".
-------	------------------------------	-------------------------------------------------------------------------------------------------------------------------------------------------

7.6.5.2 Setting frequency

510 Setting Frequency

517 Setting Frequency Switch Off Delta

If operation mode 4 - "Setting frequency" is selected for a digital output, the corresponding output will be active if the actual value *Stator frequency* **210** is greater than the value of *Setting Frequency* **510**.

¹ Refer to application manual "PLC".

² Comply with instructions on CANopen.

The relevant output is switched over again once the *Stator frequency 210* drops below the value "*Setting frequency 510* minus *Setting Frequency Switch Off Delta 517*".

Signal source 164 - "Setting frequency" can be linked to the functions of the frequency inverter.

Parameters		Setting		
No.	Description	Min.	Max.	Fact. sett.
510	Setting Frequency	0.00 Hz	599.00 Hz	3.00 Hz
517	Setting Frequency Switch Off Delta	0.00 Hz	599.00 Hz	2.00 Hz

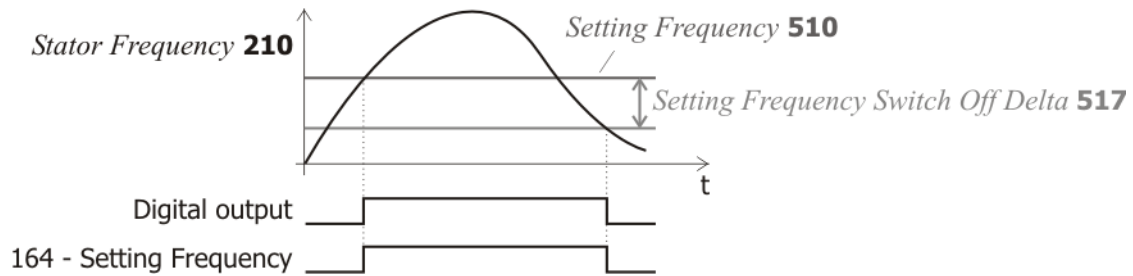

If *Setting Frequency Switch Off Delta 517* > *Setting Frequency 510* the output is never reset after the first switching on. Set up fitting values during commissioning.

<i>Operation mode OUT1D (X13.5) 531</i> (digital output)	or	4 - Setting frequency
<i>Operation mode OUT2D (X10/relay) 532</i>	or	
<i>Operation mode OUT3D (X11.6) 533</i> (digital input/output)	or	
<i>Digital: Source MFO1D 554</i> (multifunction output)		
<i>Setting frequency 510</i>		Set the value [Hz].
For linking to functions		164 - Setting frequency

7.6.5.3 Reference value reached

549 Reference Value Reached: Tolerance Band

In operation mode 5 - "Reference frequency reached" for a digital output, a message is generated via the corresponding output when the actual frequency has reached the reference value.

In operation mode 6 - "Reference percentage reached" for a digital output, a message is generated via the corresponding output when the actual percentage has reached the reference value.

Signal source 163 - "Reference frequency reached" or 178 - "Reference percentage reached" can be linked to the functions of the frequency inverter.

The hysteresis can be defined as a percentage of the adjustable range (Max - Min) via parameter *Reference Value Reached: Tolerance Band 549*.

Parameters		Setting		
No.	Description	Min.	Max.	Fact. sett.
549	Reference Value Reached: Tolerance Band	0.01%	20.00%	5.00%

<i>Operation mode OUT1D (X13.5) 531</i> (digital output)	or	5 - Reference frequency reached
<i>Operation mode OUT2D (X10/relay) 532</i>	or	or
<i>Operation mode OUT3D (X11.6) 533</i> (digital input/output)	or	6 - Reference percentage reached
<i>Digital: Source MFO1D 554</i> (multifunction output)		reached
<i>Reference Value Reached: Tolerance Band 549</i>		Set the value [%].
For linking to functions		163 - Reference frequency reached or 178 - Reference percentage reached

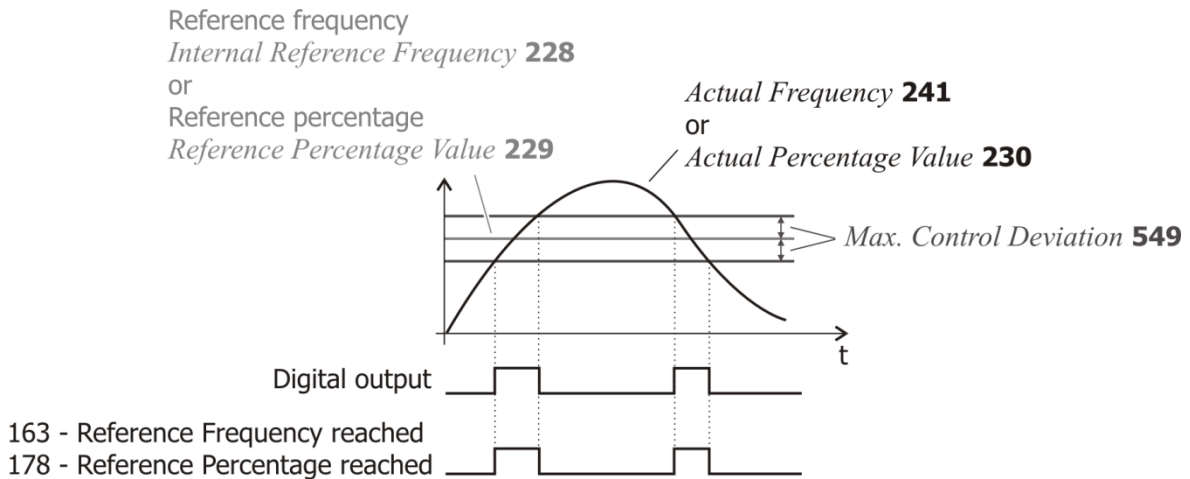

Example:

$$\begin{aligned} \text{Maximum control deviation [Hz]} &= \Delta f \times \text{Reference Value Reached} : \text{Hysteresis } 549 [\%] \\ &= (\text{Maximum Frequency } 419 - \text{Minimum Frequency } 418) \times \text{Reference Value Reached} : \text{Hysteresis } 549 [\%] \\ &= (50 \text{ Hz} - 3.5 \text{ Hz}) \times 5\% = 2.325 \text{ Hz} \end{aligned}$$

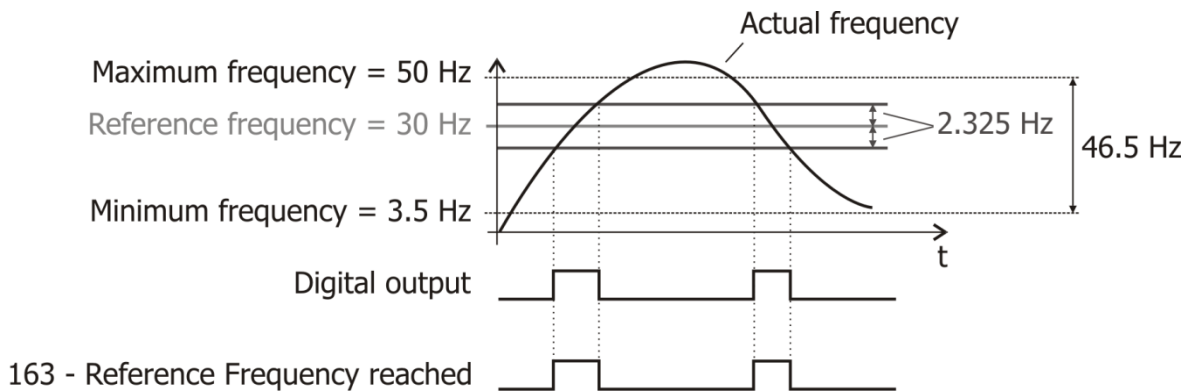

7.6.5.4 Flux forming finished

If operation mode "30 - flux forming finished" is selected for a digital output, the corresponding output becomes active when the flux-formation is finished. The time for the flux-formation results from the operating state of the machine and the set parameters for magnetizing the machine. The magnetizing can be defined via the starting behaviour and is influenced by the amount of the set starting current. See chapter 7.3.2 "Starting behaviour".

7.6.5.5 Release brake

The Open brake function in operation mode 41 enables the activation of a corresponding unit via the digital control output. The function uses both the control commands via the contact inputs and the set starting and stopping behaviour for controlling the digital output.

According to the configured starting behaviour, the output is switched on when the magnetizing of the motor is finished. When the *Brake release time* **625** has elapsed, the drive is accelerated. See chapter 7.3.2 "Starting behaviour".

The stopping behaviour of the drive depends on the configuration of the parameters *Operation mode* **630**. See chapter 7.3.3 "Stopping behaviour".

If stopping behaviour 2 or 5 with stop function is selected, the drive is controlled to zero speed and the digital output is not switched off. In the other operation modes of the stop behaviour, the control of the brake is possible. At the start of a free coasting of the drive, the digital output is switched off.

This is similar to the behaviour in the case of stopping behaviour with shutdown. The drive is de-celerated and supplied with current for the set holding time. Within the set holding time, the control output is switched off and thus the brake activated.

Control of Brake	
Stopping behaviour 0	Operation mode "41 - Open brake" switches off the digital output assigned to the function immediately. The mechanical brake is activated.
Stopping behaviour 1, 4	Operation mode "41 - Open brake" switches off the digital output assigned to the function when the <i>Switch-off threshold stop function</i> 637 is reached. The mechanical brake is activated.
Stopping behaviour 2, 5	Operation mode "41 - Open brake" leaves the digital output assigned to the function switched on. The mechanical brake remains open.
Stopping behaviour 7	Operation mode "41 - Open brake" switches off the digital output assigned to the function when the <i>Braking time</i> 632 has elapsed. The mechanical brake is activated.

7.6.5.6 Current limitation

Operation modes 15 to 19 link the digital outputs and the relay output to the functions of the intelligent current limits. The reduction of power by the set figure in percent of the rated current depends on the selected operation mode. Accordingly, the event for intervention of the current limitation can be output via the operation modes of the digital outputs. If the function of the intelligent current limits is deactivated within the sensorless control, operation modes 16 to 19 are switched off in the same way.

7.6.5.7 External fan

Operation mode "43 - external fan" enables the control of an external fan. Via the digital output, the fan is switched on as soon as the *Switch-on temperature* **39** for the internal fans was reached. See chapter 7.10.2 "Fan".

7.6.5.8 Warning mask

536 Create warning mask

The Warning mask signals via a digital signal if an afore configured warning applies. The configuration of the Warning mask is carried out via *Create warning mask* **536**. Warnings and controller status messages can be combined. This enables internal or external control using a common output signal. The display of *Warning* **269** and *Controller Status* **275** is not affected by the Warning mask.

Select a setting 1 ... 43 for message activation.

Select a setting 101 ... 143 for deactivation of a message.

<i>Create warning mask</i> 536	Function
0 - No change	Configured warning mask is not modified.
1 - Activate everything	The warnings and controller status messages stated are linked in the warning mask.
2 - Activate all Warnings	The warnings reports stated are linked in the warning mask.
3 - Activate all controller states	The controller status reports stated are linked in the warning mask.
10 - Activate Warning Ixt	The frequency inverter is overloaded
11 - Activate Warning short-term Ixt	Overload reserve for 1 s minus the <i>Warning limit short-term Ixt</i> 405 has been reached.

KFU A2- / A4-

Create warning mask 536	Function
12 - Activate Warning long-term Ixt	Overload reserve for 60 s minus the <i>Warning limit long-term Ixt</i> 406 has been reached.
13 - Activate Warning heat sink temperature	Max. heat sink temperature T_K minus the <i>Warning limit heat sink temp.</i> 407 reached.
14 - Activate Warning inside temperature	Max. inside temperature T_K minus the <i>Warning limit inside temp.</i> 408 reached.
15 - Activate Warning limit	The controller stated in <i>Controller Status</i> 275 limits the reference value.
16 - Activate Warning Init	Frequency inverter is being initialized
17 - Activate Warning Motor Temperature	Warning behaviour according to parameterized <i>Operation Mode Motor Temp.</i> 570 at maximum motor temperature T_{PTC} .
18 - Activate Warning Mains Failure	<i>Phase Supervision</i> 576 reports a phase failure.
19 - Activate Warning Motor Protective Switch	<i>Operation Mode</i> 571 for motor circuit breaker triggered.
20 - Activate Warning Fmax	The <i>Maximum Frequency</i> 419 was exceeded. The frequency limitation is active
21 - Activate Warning analog input MFI1A	The input signal at analog input MFI1A is less than 1 V/2 mA in accordance with operation mode <i>Error/Warning Behaviour</i> 453 .
22 - Activate Warning analog input MFI2A	The input signal at analog input MFI2A is less than 1 V/2 mA in accordance with operation mode <i>Error/Warning Behaviour</i> 563 .
23 - Activate Warnings system bus	A slave on the system bus signals an error.
24 - Activate Warning Udc	The DC link voltage has reached the type-dependent minimum value.
25 - Activate Application Warning	A warning application is signalled.
30 - Activate Warning Controller Udc Dynamic Operation	Controller is active according to <i>Operation Mode</i> 670 .
31 - Activate Warning Controller Shutdown	The output frequency in the case of a power failure is below the <i>Shutdown Threshold</i> 675 .
32 - Activate Warning Controller Mains Failure	Failure of the mains voltage and power regulation active according to <i>Operation Mode</i> 670 for the voltage controller.
33 - Activate Warning Controller Udc Limitation	The DC link voltage has exceeded the <i>Reference DC-Link Limitation</i> 680 .
34 - Activate Warning Controller Voltage Pre-Control	The <i>Dyn. Voltage Pre-Control</i> 605 accelerates the control characteristics.
35 - Activate Warning Controller I abs.	The output current is limited.
36 - Activate Warning Controller Torque Limitation	The output power or the torque is limited by the speed controller.
37 - Activate Warning Controller Torque Control	Switch-over of field-orientated control between speed and torque-controlled control method.
38 - Activate Warning Ramp Stop	The <i>Operation Mode</i> 620 selected in starting behavior limits the output current.
39 - Activate Warning Contr. Intel. Curr. Lim. LT-Ixt	Overload limit of the long-term Ixt (60 s) reached, intelligent current limits active.
40 - Activate Warning Contr. Intel. Curr. Lim. ST-Ixt	Overload limit of the short-term Ixt (1 s) reached, intelligent current limits active.
41 - Activate Warning Contr. Intel. Curr. Lim. Tc	Max. heat sink temperature T_K reached, <i>Operation Mode</i> 573 for intelligent current limits active.
42 - Activate Warning Contr. Intel. Curr. Lim. Motor Temp.	Max. motor temperature T_{PTC} reached, <i>Operation Mode</i> 573 for intelligent current limits active.
43 - Activate Warning Controller Freq. Limitation	Reference frequency reached the <i>Maximum Frequency</i> 419 . The frequency limitation is active.
101 to 143	Deactivation of the operation mode within the warning mask.

The selected warning mask can be read out via parameter *Actual Warning Mask* **537**. The above operation modes of parameter *Create Warning Mask* **536** are encoded in the *Actual Warning Mask* **537**. The code is calculated by hexadecimal addition of the individual operation modes and the corresponding abbreviation.

Warning code				Create Warning Mask 536
A	FFFF	FFFF	-	1 - Activate everything
A	0000	FFFF	-	2 - Activate all warnings
A	FFFF	0000	-	3 - Activate all controller states
A	0000	0001	Ixt	10 - Warning Ixt
A	0000	0002	IxtSt	11 - Warning short-term Ixt
A	0000	0004	IxtLt	12 - Warning long-term Ixt
A	0000	0008	Tc	13 - Warning heat sink temperature
A	0000	0010	Ti	14 - Warning inside temperature
A	0000	0020	Lim	15 - Warning limit
A	0000	0040	INIT	16 - Warning Init
A	0000	0080	MTemp	17 - Motor temperature warning
A	0000	0100	Mains	18 - Warning mains failure
A	0000	0200	PMS	19 - Warning motor circuit breaker
A	0000	0400	Flim	20 - Warning Fmax
A	0000	0800	A1	21 - Warning analog input MFI1A
A	0000	1000	A2	22 - Warning analog input MFI2A
A	0000	2000	Sysbus	23 - Warning system bus
A	0000	4000	UDC	24 - Warning Udc
A	0000	8000	WARN2	25 - Warning, application
A	0001	0000	UDdyn	30 - Controller Udc dynamic operation
A	0002	0000	UDstop	31 - Controller shutdown
A	0004	0000	UDctr	32 - Controller mains failure
A	0008	0000	UDlim	33 - Controller Udc limitation
A	0010	0000	Boost	34 - Controller voltage pre-control
A	0020	0000	Ilim	35 - Controller I abs
A	0040	0000	Tlim	36 - Controller torque limitation
A	0080	0000	Tctr	37 - Controller torque control
A	0100	0000	Rstp	38 - Ramp stop
A	0200	0000	IxtLtim	39 - Contr. intel. curr. lim. LT-Ixt
A	0400	0000	IxtStlim	40 - Contr. intel. curr. lim. ST-Ixt
A	0800	0000	Tclim	41 - Contr. intel. curr. lim. Tc
A	1000	0000	MtempLim	42 - Contr. intel. curr. lim. motor temp.
A	2000	0000	Flim	43 - Controller Freq. Limitation

Output signals

The output of a warning is signalled.

157 -	Warning	Output of warning activated in <i>Create Warning Mask</i> 536 .
25 -	mask	

¹⁾ For linking to frequency inverter functions.

²⁾ For output via a digital output. Select the signal source for one of the parameters 531, 532, 533, 554. See chapter 7.6.5 "Digital outputs".



Parameter *Warning 269* and *Warning 356* (error environment) show the warnings independent from the created Warning mask.
 Parameter *Controller Status 275* and *Controller Status 355* (error environment) show the Controller Status independent from the created Warning mask.

7.6.5.9 Warning mask, application

626 Create Warning Mask Application

The Warning mask Application signals via a digital signal if an afore configured warning applies. The configuration of the Warning mask Application is carried out via *Create Appl. Warning Mask 626*. Depending on the application, any number of warnings can be configured. This enables internal and/or external control using a common output signal. The display of *Warning Application 273* is not affected by the Warning mask.

<i>Create Appl. Warning Mask 626</i>	Function
0 - No change	The configured warning mask is not changed.
2 - Activate all warnings	The warnings reports stated are linked in the warning mask.
10 - Warning V-belt	<i>Operation Mode 581</i> for V-belt monitoring signals no-load operation of the application.
16 - Warning Service	The time remaining until service of DC-link or fan has expired.
17 - Warning User 1	The signal set on digital input <i>User Warning 1 1363</i> is active.
18 - Warning User 2	The signal set on digital input <i>User Warning 2 1364</i> is active.
102 - Deactivate all warnings	All warnings are deactivated.
110 - Deactivate warning V-belt	Warning 10 is deactivated.
116 - Deactivate warning service	Warning 16 is deactivated.
117 - Deactivate warning User 1	Warning 17 is deactivated.
118 - Deactivate warning User 2	Warning 18 is deactivated.

The selected warning mask application can be read out via parameter *Actual Appl. Warning Mask 627*. The above operation modes of parameter *Create Appl. Warning Mask 626* are encoded in the *Actual Appl. Warning Mask 627*. The code is calculated by hexadecimal addition of the individual operation modes and the corresponding abbreviation.

Warning code	<i>Create Appl. Warning Mask 626</i>
A 01C1 -	2 - Activate all warnings
A 0001 BELT	10 - Warning V-belt
A 0040 SERVICE	16 - Warning Service
A 0080 User 1	17 - Warning User 1
A 0100 User 2	18 - Warning User 2

Output signals

The output of a warning is signalled.

215 -	Warning mask, application	1)	Output of warning activated in <i>Create Appl. Warning Mask 626</i> .
27 -		2)	

¹⁾ For linking to frequency inverter functions.

²⁾ For output via a digital output. Select the signal source for one of the parameters 531, 532, 533, 554. See chapter 7.6.5 "Digital outputs".



Parameter *Warning Application 273* shows the Application Warnings independent from the created Warning mask.

7.6.6 Digital inputs

The assignment of the control signals to the available software functions can be adapted to the application in question. In addition to the available digital control inputs, further internal logic signals are available as sources.

Each of the individual software functions is assigned to the various signal sources via parameterizable inputs. This enables a flexible use of the digital control signals.

559 Digital inputs PNP/NPN

Via parameter *Digital inputs PNP/NPN* **559**, the evaluation at the digital inputs can be selected as PNP (high-switching) or NPN (low-switching).

Terminal	<i>Digital inputs PNP/NPN</i> 559	Function
X11.4 X11.5 X11.6	0 - NPN (active: 0 V)	Digital input NPN. Low-switching (with negative signal).
X12.1 X12.2	1 - PNP (active: 24 V)	Digital input PNP. High-switching (with positive signal). Factory setting.

In order to use multifunction input MF11 as a digital input, setting 3 or 4 must be selected for parameter *Operation Mode MF11* **452**.

Terminal	<i>Operation Mode MF11</i> 452	Function
X12.3	3 - Digital NPN (active: 0 V)	Low-switching (with negative signal).
	4 - Digital PNP (active: 24 V)	High-switching (with positive signal).

In order to use multifunction input MF12 as a digital input, setting 3 or 4 must be selected for parameter *Operation Mode MF12* **562**.

Terminal	<i>Operation Mode MF12</i> 562	Function
X12.4	3 - Digital NPN (active: 0 V)	Low-switching (with negative signal). Factory setting.
	4 - Digital PNP (active: 24 V)	High-switching (with positive signal).

In order to use the digital input/output (terminal X11.6) as a digital input, setting "0 - Input IN3D" must be selected for parameter *Operation Mode Terminal X11.6* **558**.

Terminal	<i>Operation Mode Terminal X11.6</i> 558	Function
X11.6	0 - Input IN3D	The digital input/output is set as digital input. Factory setting.

For setting of X11.6 as digital output, refer to chapter 7.6.4 "Digital input/output IN3D/OUT3D".

7.6.6.1 List of control signals

- Select the function that is to be controlled. For example Start drive in anticlockwise operation.
- Select the control signal for the parameter of the function. For example select "74 - IN4D" for parameter *Start Anticlockwise* **69**. In this case the drive starts anticlockwise operation if a signal applies on digital input IN4D (enable signal must also be set).

Control signals Selection for parameter	Function
6 - On	Signal input is switched on.
7 - Off	Signal input is switched off.
70 - Inverter Release	Enable signal of the frequency inverter via digital inputs STOA (X11.3) and STOB (X13.3). Or enable signal in remote mode via communication interface.

KFU A2- / A4-

Control signals Selection for parameter	Function
71 - IN1D	Signal at digital input IN1D (X11.4). Or signal in remote mode via communication interface.
72 - IN2D	Signal at digital input IN2D (X11.5). Or signal in remote mode via communication interface.
73 - IN3D	Signal at digital input IN3D (digital input/output, X11.6) in <i>Operation Mode Terminal X11.6 558</i> = "0 - input IN3D". Or signal in remote mode via communication interface.
74 - IN4D	Signal at digital input IN4D (X12.1). Or signal in remote mode via communication interface.
75 - IN5D	Signal at digital input IN5D (X12.2). Or signal in remote mode via communication interface.
76 - MFI1D	Signal at multifunction input MFI1 (X12.3) in <i>Operation mode MFI1 452</i> "3 - digital NPN (active: 0 V)" or "4 - digital PNP (active: 24 V)". Or signal in remote mode via communication interface.
77 - MFI2D	Signal at multifunction input MFI2 (X12.) in <i>Operation Mode MFI2 562</i> "3 - Digital NPN (active: 0 V)" or "4 - Digital PNP (active: 24 V)". Or signal in remote mode via communication interface.
157 - Warning Mask	The defined warning mask of parameter <i>Create Warning Mask 536</i> signals a critical operating point.
160 - Ready Signal	Frequency inverter is initialized and ready for operation.
161 - Run Signal	Enable signals (STOA and STOB) and a start command (<i>Start Clockwise 68</i> or <i>Start Anticlockwise 69</i>) are applied, output frequency present.
162 - Error Signal	Monitoring function signals an operational fault.
163 - Reference Frequency reached	Signal when the <i>Actual Frequency 241</i> has reached the reference frequency
164 - Setting Frequency	The actual <i>Stator Frequency 210</i> is higher than the value of <i>Setting Frequency 510</i> .
165 - Warning Ixt	The monitoring functions report an overload of the frequency inverter
166 - Warning Heat Sink Temperature	Maximum heat sink temperature T_K minus the <i>Warning Limit Heat Sink Temp. 407</i> reached.
167 - Warning Inside Temperature	Maximum inside temperature T_i minus the <i>Warning Limit Inside Temp. 408</i> reached.
168 - Warning Motor Temperature	Warning behaviour according to parameterized <i>Operation Mode Motor Temp. 570</i> at maximum motor temperature T_{PTC} .
169 - General Warning	Signal when <i>Warnings 269</i> are displayed with a critical operating point
170 - Warning Overtemperature	The value <ul style="list-style-type: none"> - (Maximum heat sink temperature T_K) minus (<i>Warning Limit Heat Sink Temp. 407</i>) or - (Maximum inside temperature T_i) minus (<i>Warning Limit Inside Temp. 408</i>) was reached.
175 - Digital Signal OUT1D	Signal selected via <i>Op. Mode OUT1D (X13.5) 531</i> .
176 - Digital Signal OUT2D Relay	Signal selected via <i>Op. Mode OUT2D (X10/Relay) 532</i> .
177 - Digital Signal OUT3D	Signal selected via <i>Op. Mode OUT3D (X11.6) 533</i> .
178 - Reference Percentage reached	Signal when the <i>Actual Percentage Value 230</i> has reached the <i>Reference Percentage Value 229</i> .
179 - Mains Failure	Failure of the mains voltage and power regulation active according to <i>Operation Mode 670</i> for the voltage controller.
180 - Warning Motor Protection Switch	Parameterized <i>Operation Mode 571</i> of the motor circuit breaker triggered.

Control signals Selection for parameter	Function
181 - Digital Signal MFO1D	Signal selected via <i>Digital: Source MFO1D</i> 554 .
215 - Warning Mask, Application	The defined warning mask of parameter <i>Create Appl. Warning Mask</i> 626 signals a critical operating point.
216 - Application Warning	All Application Warnings are deactivated. Display is effected via parameter <i>Application Warnings</i> 273 .
219 - Technology Controller within Backlash	The control deviation lies within the range defined by <i>Backlash</i> 618 .
264 - Warning service DC-link	Signal if the time remaining until service has expired. Parameter <i>Operation Mode Service Interval DC-link</i> 1534 must be set to "2 - Alarm Message". Parameter <i>Maintenance Note</i> 1533 displays a message.
265 - Warning service fan	Signal if the time remaining until service has expired. Parameter <i>Operation Mode Service Interval Fan</i> 1535 must be set to "2 - Alarm Message". Parameter <i>Maintenance Note</i> 1533 displays a message.
270 to 277	Operation modes 70 to 77 of the digital inputs inverted (LOW active).
284 - STOA inverted	Inverted signal status on digital input STOA for enable.
285 - STOB inverted	Inverted signal status on digital input STOB for enable.
292 - STOA	Signal status on digital input STOA for enable.
293 - STOB	Signal status on digital input STOB for enable.
323 - Power is on	Signal if mains voltage is switched on and pre-charging is finished.
471 - Energy saving function is active	Parameter <i>Operation mode energy saving function</i> 1550 is set to "1 - manual" or "2 - automatic". The digital input or logic signal selected for parameter <i>Energy saving function on</i> 1552 has switched on the energy saving function.
525 - Inverter Release(Hardware)	Enable signal of the frequency inverter via digital inputs STOA (X11.3) and STOB (X13.3).
526 - IN1D (Hardware)	Signal at digital input IN1D (X11.4).
527 - IN2D (Hardware)	Signal at digital input IN2D (X11.5).
528 - IN3D (Hardware)	Signal at digital input IN3D (digital input/output, X11.6) in <i>Operation Mode Terminal X11.6</i> 558 = "0 - Input IN3D".
529 - IN4D (Hardware)	Signal at digital input IN4D (X12.1).
530 - IN5D (Hardware)	¹ Signal at digital input IN5D (X12.2).
531 - MFI1D (Hardware)	Signal at multifunction input MFI1 (X12.3) in <i>Operation Mode MFI1</i> 452 "3 - Digital NPN (active: 0 V)" or "4 - Digital PNP (active: 24 V)".
532 - MFI2D (Hardware)	Signal at multifunction input MFI2 (X12.) in <i>Operation Mode MFI2</i> 562 "3 - Digital NPN (active: 0 V)" or "4 - Digital PNP (active: 24 V)".
537 to 544	Operation modes 525 to 532 of the digital inputs inverted (LOW active).
640 Out-PZD3 Boolean to to 655 Out-PZD18 Boolean	² Process data for Profibus communication. Optional communication module CM-PDP-V1 with Profibus interface is required.

¹ The digital signal is independent from the configuration of the parameter *Local/Remote* **412**.

² Refer to instructions on Profibus.

Control signals Selection for parameter	Function
700 - RxPDO1 Boolean1	Process data object for system bus communication.
701 - RxPDO1 Boolean2	Process data object for system bus communication.
702 - RxPDO1 Boolean3	Process data object for system bus communication.
703 - RxPDO1 Boolean4	1 Process data object for system bus communication.
710 to 713	Operation modes 700 to 703 for RxPDO2.
720 to 723	Operation modes 700 to 703 for RxPDO3.
730 - Sysbus emergency	Signal of system bus communication.
810 Obj 0x3003 DigOut 1 to to 814 Obj 0x3003 DigOut 5	2 Sources of CAN objects for CANopen® communication.
832 Obj 0x3005 Demux to 847 Out 1 to Obj 0x3005 Demux Out 16	Sources at output of demultiplexer for CANopen® communication.
910 Output DeMux bit 0 to 925 Output DeMux bit 15	3 Bit 0 to Bit 15 on output of de-multiplexer; de-multiplexed process data signal via system bus or Profibus on input of multiplexers (parameter <i>DeMux Input 1253</i>).
2401 PLC-Output Buffer 1 to 2416 PLC-Output buffer 16	4 Output signals of PLC-functions.



Signals via physical contacts (IN1D...IN5D, MFI1, MFI2) are only evaluated if an operation mode *Local/Remote 412* with "Control via Contact" or "Control 3-Wire" (0, 4 or 5) is selected.

In all other operation modes *Local/Remote 412* (1, 2, 3) physical contacts are only evaluated, if the corresponding signals in the digital inputs with the suffix (Hardware) are selected.

Signals not referring to a physical input are evaluated independent of the operation mode *Local/Remote 412*.

7.6.6.2 Start command

68 Start Clockwise

69 Start Anticlockwise

The parameters *Start Clockwise 68* and *Start Anticlockwise 69* can be linked to the available digital control inputs or the internal logic signals. The drive is only accelerated according to the control method after a start command.

The logic functions are used for the specification of the direction of rotation, but also for using the parameterized *Operation Mode 620* for the starting behaviour and *Operation Mode 630* for the stopping behaviour.

Parameter	Factory setting
<i>Start Clockwise 68</i>	71 – IN1D
<i>Start Anticlockwise 69</i>	72 – IN2D

7.6.6.33-Wire Control

¹ Refer to instructions on system bus.

² Refer to instructions on CANopen.

³ Refer to instructions on system bus or Profibus.

⁴ Refer to application manual PLC.

87 Start 3-Wire Ctrl

In the case of 3-wire control, the drive is controlled using digital pulses. The drive is prepared for starting via the logic state of the signal *Start 3-Wire Ctrl* **87** and started by a Start clockwise pulse (Parameter *Start Clockwise* **68**) or a start anticlockwise pulse (parameter *Start Anticlockwise* **69**). By switching off the signal *Start 3-Wire Ctrl* **87**, the drive is stopped.

The control signals for Start clockwise and Start anticlockwise are pulses. The functions Start clockwise and Start anticlockwise for the drive are latching-type functions when signal *Start 3-Wire Ctrl* **87** is switched on. Latching is cancelled when the latching signal is switched off.

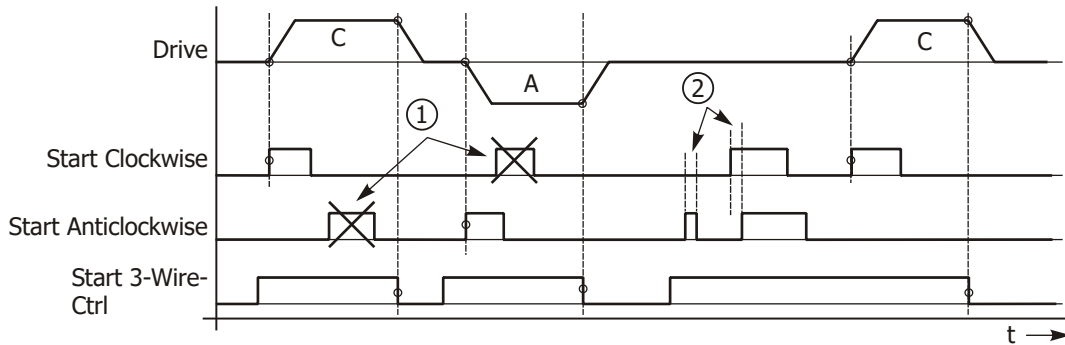

- (C) Clockwise
- (A) Anticlockwise
- (1) Signals are ignored
- (2) Time $t < 32$ ms

The drive is started according to the configured starting behaviour if the signal *Start 3-Wire Ctrl* **87** is switched on and a positive signal edge for Start clockwise or Start anticlockwise is detected.

Once the drive has started, new edges (1) on the start signals will be ignored.

If the start signal is shorter than 32 ms (2) or if both start signals were switched on within 32 ms (2), the drive will be switched off according to the configured stopping behaviour.

3-wire control is activated with parameter *Local/Remote* **412**:

<i>Local/Remote</i> 412	Function
5 - Control 3-wire	Control of direction of rotation (parameter <i>Start Clockwise</i> 68 , <i>Start Anticlockwise</i> 69) and signal <i>Start 3-Wire Ctrl</i> 87 via digital inputs.

See chapter 7.3 "Operational Behaviour".

" for further operation modes of parameter *Local/Remote* **412**.

Parameter	Factory setting
<i>Start 3-Wire Ctrl</i> 87	7 - Off

7.6.6.4 Motor potentiometer

62 Frequency Motorpoti Up

63 Frequency Motorpoti Down

The reference frequency of the drive can be set via digital control signals. See chapter 7.5.3.3.1 "Control via reference frequency channel".

Parameter	Factory setting
<i>Frequency Motorpoti Up</i> 62	7 - Off
<i>Frequency Motorpoti Down</i> 63	7 - Off

72 *Percent Motorpoti Up*

73 *Percent Motorpoti Down*

The reference percentage can be set via digital control signals. See chapter 7.5.3.3.2 "Control via reference percentage channel".

Parameter	Factory setting
<i>Frequency Motorpoti Up</i> 62	7 - Off
<i>Frequency Motorpoti Down</i> 63	7 - Off

7.6.6.5 Fixed frequency changeover

66 *Fixed Frequency Change-Over 1*

67 *Fixed Frequency Change-Over 2*

131 *Fixed Frequency Change-Over 3*

By combining the logic states of the fixed frequency changeover modes 1, 2 and 3, the fixed frequencies 1 to 8 (parameters 480 to 488) can be selected. See chapter 7.5.1.3 "Fixed frequencies".

“.

Parameter	Factory setting
<i>Fixed Frequency Change-Over 1</i> 66	74 - IN4D
<i>Fixed Frequency Change-Over 2</i> 67	7 - Off
<i>Fixed Frequency Change-Over 3</i> 131	7 - Off

7.6.6.6 Fixed percentage changeover

75 *Fixed Percent Change-Over 1*

76 *Fixed Percent Change-Over 2*

By combining the logic states of *Fixed Percent Change-Over 1* **75** and *Fixed Percent Change-Over 2* **76**, the fixed percentages 1 to 4 (Parameters 520 to 523) can be selected. See chapter 7.5.2.3 "Fixed percentages".

Parameter	Factory setting
<i>Fixed Percent Change-Over 1</i> 75	7 - Off
<i>Fixed Percent Change-Over 2</i> 76	7 - Off

7.6.6.7 Jog Start

81 JOG Start

The selected signal source starts the JOG-function. The drive accelerates to the rotary frequency set via parameter *JOG Frequency* **489**.

Parameter	Factory setting
<i>JOG Start</i> 81	7 - Off

7.6.6.8 Error Acknowledgment

103 *Error Acknowledgement*

The frequency inverters feature various monitoring functions which can be adapted via the error and warning behaviour. Switching the frequency inverter off at the various operating points should be avoided by an application-related parameterization. If there is a fault switch-off, this report can be given via the parameter *Program(ming)* **34** or the logic signal can be acknowledged with parameter *Error Acknowledgment* **103**.

Parameter	Factory setting
<i>Error Acknowledgment</i> 103	75 - IN5D

Possibilities of error acknowledgement:

- Via the Stop key of the operator panel

A reset via the STOP key can only be executed, if Parameter *Local/Remote* **412** allows the control via keypad

- via parameter *Program(ming)* **34**
- via parameter *Error Acknowledgement* **103** which is assigned a logic signal or a digital input

A reset via a digital input can only be executed, if Parameter *Local/Remote* **412** allows that control or if a physical input with the suffix (Hardware) is selected.

- When using a Fieldbus and control via Statemachine: Setting the reset bit in the Control-word. Refer to the Communication manuals for details.

7.6.6.9 Thermal contact

204 Thermal contact for P570

The monitoring of the motor temperature is a part of the error and warning behaviour which can be configured as required. Parameter *Thermal contact for P570* **204** links the digital input signal to the *Operation Mode Motor Temp.* **570**. See chapter 7.4.6 "Motor temperature". By default, multifunction input 2 is used for connection of a thermal contact.

Parameter	Factory setting
<i>Thermal contact for P570</i> 204	532 - MFI2D (Hardware), multifunction input 2 (terminal X12.4)
<i>Operation Mode Motor Temp.</i> 570	0 - Off

- For parameter *Thermal contact for P570* **204**, the digital input to which the thermal contact is connected must be selected.
- For parameter *Operation Mode Motor Temp.* **570**, select an evaluation (warning or error switch-off).

If a multifunction input is selected for parameter *Thermal contact for P570* **204**, the multifunction input must be configured as a digital input:

Multifunction input 1	<i>Operation Mode MFI1</i> 452	3 -	Digital NPN (active: 0 V)
		4 -	Digital PNP (active: 24 V)
Multifunction input 2	<i>Operation Mode MFI2</i> 562	3 -	Digital NPN (active: 0 V) Factory setting
		4 -	Digital PNP (active: 24 V)

Select NPN or PNP according to the required evaluation of the thermal contact.

If a thermal contact is connected to multifunction input 2, no change of *Thermal contact for P570* **204** and *Operation Mode MFI2* **562** is required in the factory setting. You only have to set up the required evaluation via parameter *Operation Mode Motor Temp.* **570**.

7.6.6.10 n-/T-control changeover

164 n-/T-Control Change-Over

The field-orientated control procedures in configurations 410 and 610 contain the functions for speed or torque-de-pendent control of the drive. The changeover can be done in ongoing operation, as an additional functionality monitors the transition between the two control systems. The speed controller or the torque controller is active, depending on the *n-/T-Control Change-Over* **164**.

For information on how to set up the speed controller, refer to chapter 7.9.5.3 "Speed controller".

For information on how to set up the torque controller, refer to chapter 7.9.5.2 "Torque controller".

Parameter	Factory setting
<i>n-/T-Control Change-Over</i> 164	7 - Off

7.6.6.11 Dataset changeover

70 Data Set Change-Over 1

71 Data Set Change-Over 2

Parameter values can be stored in four different data sets. This enables the use of various parameter values depending on the current operation point of the frequency inverter. The changeover between the four data sets is done via the logic signals assigned to the parameters *Data Set Change-Over 1 70* and *Data Set Change-Over 2 71*.

Addressing		
<i>Data Set Change-Over 1 70</i>	<i>Data Set Change-Over 2 71</i>	Active data set
0	0	Data set 1 (DS1)
1	0	Data set 2 (DS2)
1	1	Data set 3 (DS3)
0	1	Data set 4 (DS4)

0 = contact open 1 = contact closed

Parameter	Factory setting	Terminal
<i>Data Set Change-Over 1 70</i>	73 - IN3D	X11.6
<i>Data Set Change-Over 2 71</i>	7 - Off	-

The actual value parameter *Active Data Set 249* shows the selected data set.

Save in a data set: parameter values that are measured during Setup

- Select "Setup" manually in menu of operator panel.

The data set selection is displayed.

- Select data set 0 if all data sets are to contain the same parameter values.
- Select one of the data sets 1 ... 4 for commissioning of several motors or for different operating points.

Example: For auto set-up (auto-tuning) and motor data, select data set 1.

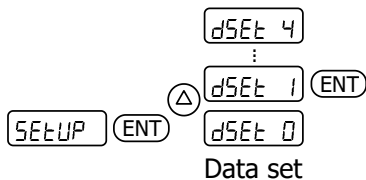

If "Setup" is performed, the entered and measured motor data is saved in the selected data set.

Set a parameter value in a data set

Example: Set nominal motor voltage P370 in data set 2.

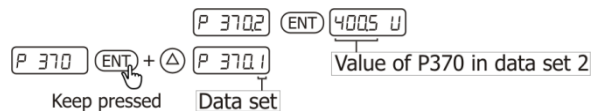

When the frequency inverter is switched on for the first time, the data set selection is not displayed. In this case, all entered and measured motor data will be saved in all four data sets.

7.6.6.12 Handshake Traverse

49 Handshake Traverse Function

Via parameter *Handshake Traverse Function* **49**, the signal source is selected for specification of the direction of rotation of the slave drive of the traverse function. The traverse function is switched on via parameter *Operation Mode* **435**. See chapter 7.10.8 "Traverse function".

Parameter	Factory setting
<i>Handshake Traverse Function</i> 49	7 - Off

7.6.6.13 Brake chopper release

95 Brake Chopper Release

Via the signal assigned to parameter *Brake Chopper Release* **95**, the brake chopper can be released or disabled. In the factory settings, the brake chopper is released if the frequency inverter release is switched on.

Parameter	Factory setting	Terminals
<i>Brake Chopper Release</i> 95	70 - Inverter Release	X11.3 and X13.3

Example:

Brake Chopper Release **95** = "6- On": The brake chopper is released.

Brake Chopper Release **95** = "7- Off": The brake chopper is disabled.

For information on how to set up the brake chopper, refer to chapter 7.10.4 "Brake chopper and brake resist".

NOTICE

A connected brake resistor is only used if the brake chopper release is present. At brake operations or other generator states an overvoltage switch off can happen if the electrical energy is not dissipated.

7.6.6.14 User warning

1363 User Warning 1

1364 User Warning 2

Parameterization of an user warning enables triggering a warning in the device via a digital signal if a critical state in the plant occurs. The warning is displayed in *Warnings Application* **273** and can be transmitted to a higher-level control like a PLC. Please check parameter *Create warning mask application* **626** and chapter 7.6.5.9 "Warning mask, application".

2 independent Warnings can be set up via *User-Warning 1* **1363** and *User-Warning 2* **1364**.

7.6.6.15 External error

183 External Error

Parameterization of an external error enables switching off or shutting down several frequency inverters at a time if a fault occurs in the plant or the drive. If an error occurs in a frequency inverter, the error signal can be transmitted via a bus system and the required reaction can be triggered in another frequency inverter. The logic signal or digital input signal which is to trigger the external error can be assigned to parameter *External Error* **183**.

Via parameter *Op. Mode ext. Error* **535**, the response to an external error can be configured. See chapter 7.4.5 "External error".

Operation Mode 535	Function
0 - Disabled	No response to external errors. Factory setting.
1 - Error-Switch-Off	The drive is switched off and the error message "F1454 External Error" is output if the logic signal or digital input signal for parameter <i>External Error</i> 183 is present.
2 - Shutdown, Error	The drive is stopped at the current deceleration ramp and the error message "F1454 External Error" is output if the logic signal or digital input signal for parameter <i>External Error</i> 183 is present.
3 - Emergency-Stop, Error	The drive is stopped at the set emergency stop ramp and the error message "F1454 External Error" is output if the logic signal or digital input signal for parameter <i>External Error</i> 183 is present.

Parameter	Factory setting
<i>External Error</i> 183	7 - Off

For setting up external warnings parameters *User Warning 1* **1363** and *User Warning 2* **1364** can be used. Check chapter 7.6.5.9 "Warning mask, application" for further details.

7.6.6.16 PLC

Logic functions and analog functions with functional block programming

With the PLC-functions (table of functions and graphic functional block programming), external analog or digital signals and internal logic signals of the frequency inverter can be linked to one another. Apart from standard AND, OR and XOR combinations, various complex logic functions and analog functions are available. The corresponding output value can be used for other logic instructions and digital outputs. Logic instructions can be combined to one another so that complex links can be realized. Analog values can be processed and output via analog outputs.

The instructions enable flexible adjustment for linking different input signals.

Analog functions include, for example, comparisons of analog input values, mathematical functions, PID control functions, filters, limitations, switches and counters.

Example:

A drive is to start if

- enable is given AND IN4D is set
- OR
- enable is given AND IN5D and MFI1D are set.

Refer to application manual "PLC".

7.6.6.17 Multiplexer/demultiplexer

The multiplexer/demultiplexer enables the transfer of various digital signals between an overriding controller and frequency inverters via field bus or between frequency inverters via the system bus.

Multiplexer:

1252 Mux Inputs

The multiplexer features 16 inputs for logic signals or digital input signals.

On the output, the logic signal 927 - "Output MUX" for the inputs of the TxPDO process data of the system bus or for PZDx-IN process data of the Profibus can be used.

Parameter		Factory setting	
1252	Mux Inputs	7 -	Off

1250 Mux Input Index (write)

1251 Mux Input index (read)

The parameters *Mux Input Index (write)* **1250** and *Mux Input Index (read)* **1251** for the input signals of the multiplexer enable parameterization via the operator panel or the application VTable in VPlus.

Parameters		Setting		
No.	Description	Min.	Max.	Fact. sett.
1250	Mux Input Index (write) ¹⁾	0	33	1
1251	Mux Input Index (read)	0	33	1

1)	non-volatile (fixed parameterization):	Volatile:		
	0: All indices in EEPROM	17:	All indices in RAM	
	1...16: One index in EEPROM	18...33:	One index 1...16 in RAM	

NOTICE

Setting "0" for *Mux Input Index (write)* **1250** changes all data in EEPROM and RAM. In the case of non-volatile storage (0...16), the changed values are still available when power supply is switched on again. In the case of volatile storage (17...33), the data is only stored in RAM. If the unit is switched off, this data is lost and the data required are loaded from EEPROM.

Demultiplexer:

1253 DeMux Input

The demultiplexer features an input *DeMux Input* **1253** whose signal can be for the process data RxPDO of the system bus or OUT-PZDx of Profibus.

On the output of the demultiplexer, the logic signals "910 - Output DeMux Bit 0" to "925 - Output DeMux Bit15" are available, e.g. for control of PLC-functions.

Operation modes for <i>DeMux input 1253</i>	
9 -	Zero
704 ... 727 -	RxPDO Word
740, 741 -	Remote control word , remote state word
754 ... 757 -	OUT-PZD word
900 -	Controller status
927 -	Output MUX

Demultiplexer outputs	
910 ... 925 -	Output DeMux Bit 0 ... output DeMux Bit 15

Example: Transfer of a user-defined status word from a slave to a master via system bus or Profibus, parameterization of multiplexer and demultiplexer using PC application VTable in VPlus

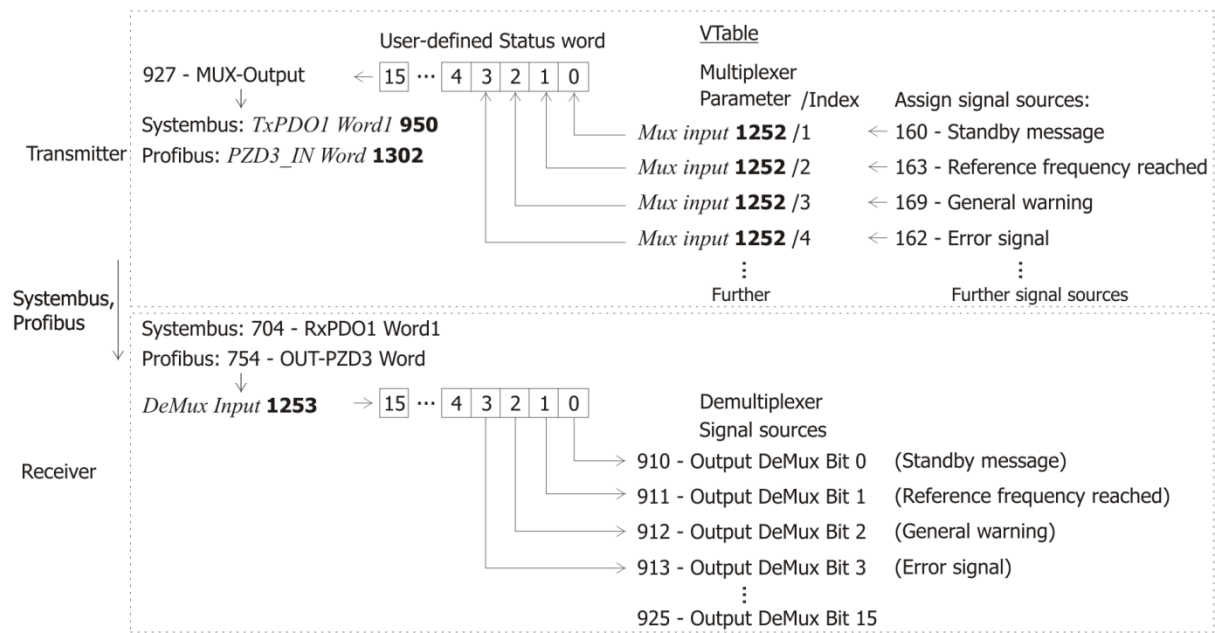

Settings on transmitter:

- In VPlus, start application VTable via the button bar.
- In VTable assign the required signal sources for sending to parameter *Mux. Inputs 1252* index 1 to index 16. A setting for index 0 results in this setting being taken over for all other indices.
- Assign signal source "927 – Output MUX" to a TxPDO process data parameter of the system bus or a PZDx-IN process data parameter of Profibus.

Settings on receiver:

- Assign the corresponding RxPDO signal sources of the system bus or OUT-PZD signal sources of Profibus to parameter *DeMux Input 1253*.

The transmitted signals are available at the receiver as signal sources 910 to 925.

7.6.7 Input PWM/repetition frequency/pulse train

496 Operation Mode IN2D (PWM/repetition frequency/pulse train)

A PWM signal (pulse-width modulated signal), frequency signal or a pulse train (pulse sequence) signal can be used for definition of a reference value. The signal at digital input IN2D (at terminal X11.5) is evaluated according to the selected *Operation Mode IN2D 496*.

Operation Mode IN2D 496	Function
0 - Off	The PWM signal or repetition frequency is zero. Factory setting.
10 - PWM, 0% – 100%	PWM signal detection at digital input IN2D (at terminal X11.5). 0 ... 100% of <i>Maximum Reference Percentage 519</i> or 0 ... 100% of <i>Maximum Frequency 419</i> . See 7.6.7.1 "PWM input".
11 - PWM, -100% – 100%	PWM signal detection at digital input IN2D (at terminal X11.5). -100 ... 100% of <i>Maximum Reference Percentage 519</i> or -100 ... 100% of <i>Maximum Frequency 419</i> . See 7.6.7.1 "PWM input".
20 - RF Single Evaluation	Repetition frequency input at digital input IN2D (at terminal X11.5). One edge of the frequency signal is evaluated. The signal can also be evaluated as a percentage. See 7.6.7.2 "Repetition frequency input".
21 - RF Double Evaluation	Repetition frequency input at digital input IN2D (at terminal X11.5). Both edges of the frequency signal are evaluated. The signal can also be evaluated as a percentage. See 7.6.7.2 "Repetition frequency input".

Operation Mode IN2D 496	Function
30 - Pulse Train	Pulse train (pulse sequence) signal at digital input IN2D (at terminal X11.5) as reference frequency. Via parameter <i>Pulse Train Scaling Frequency</i> 654 , you can set which input frequency corresponds to the value of <i>Maximum Frequency</i> 419. See ". Percentage: Via parameter <i>Pulse Train Scaling Frequency</i> 654 , you can set which percentage corresponds to the value of <i>Maximum Reference Percentage</i> 519 . The signal can also be evaluated as a percentage.



Digital input IN2D is intended for use as PWM input, repetition frequency input or pulse train input. Digital input IN2D cannot be used for other functions if the function PWM input, repetition frequency or pulse train is selected for *Operation Mode IN2D 496*.

In the factory settings, IN2D is linked to parameter *Start Anticlockwise* **69**. If the PWM, repetition frequency or pulse train input and the function "Start anticlockwise" are to be used parameter *Start Anticlockwise* **69** must be assigned another digital input.

7.6.7.1 PWM input

Digital input IN2D (terminal X11.5) can be used as PWM input. For parameter *Operation Mode IN2D 496*, select setting "10 - PWM, 0% –100%" or "11 – PWM, -100% – 100%".

For definition of reference values, the following settings can be selected:

- *Reference Percentage Source 1* **476** = "10 - Repetition Percentage Value".
- *Reference Percentage Source 2* **494** = "10 - Repetition Percentage Value".

The percentage is referred to *Maximum Reference Percentage* **519**.

652 PWM-Offset

653 PWM-Amplification

Via parameters *PWM-Offset* **652** and *PWM-Amplification* **653**, the PWM input signal can be adjusted for the application.

Parameters		Setting		
No.	Description	Min.	Max.	Fact. sett.
652	PWM-Offset	-100.00%	100.00%	0.00%
653	PWM-Amplification	5.0%	1000.0%	100.0%

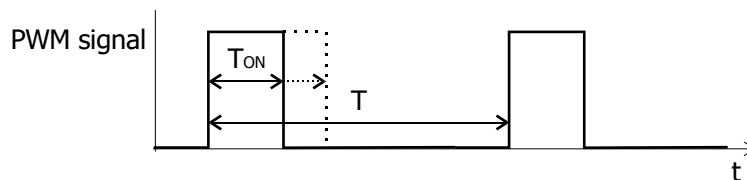

$$PWM \text{ value} = PWM - Offset \text{ 652} + \left(\frac{T_{on}}{T} [\%] \times PWM - Amplification \text{ 653} \right)$$

PWM-Input **258** shows the actual value of the PWM input.

PWM frequencies in the range between 50 Hz and 15 kHz can be evaluated.

Output as frequency value

The input percentage value can be selected as frequency value for the reference frequency channel. Parameter *Reference Frequency Source 1* **475** or *Reference Frequency Source 2* **492** enables the selection:

- 10 - PWM, 0% – 100%
- 11 - PWM, -100% – 100%

The range 0% ... 100% or -100 % ... 100 % on the PWM-input corresponds to the frequency range 0... *Maximum Frequency* **419**.

$$f = \frac{\text{Input value}}{100\%} * \text{Maximum Frequency } \mathbf{419}$$

7.6.7.2 Repetition frequency input

Digital input IN2D (terminal X11.5) can be used as repetition frequency input. For parameter *Operation Mode IN2D* **496**, "20 - RF Single Evaluation" or "21 - RF Double Evaluation" must be selected.

For definition of reference values, the following settings can be selected:

- *Reference frequency source 1* **475** = "10 - Repetition Frequency".
- *Reference frequency source 2* **492** = "10 - Repetition Frequency".

The percentage is referred to *Maximum Frequency* **419**.

497 Rep.Freq: Divider

The signal frequency at the selected repetition frequency input can be scaled via parameter *Rep.Freq: Divider* **497**. The parameter value is comparable to the number of division marks of an encoder per revolution of the drive. The frequency limit of digital input IN2D is to be taken into account for the frequency of the input signal.

Parameters		Setting		
No.	Description	Min.	Max.	Fact. sett.
497	Rep.Freq: Divider	1	8192	1024

An inverted evaluation can be set via the reference frequency channel in parameter *Operation Mode* **493**. See chapter 7.5.1.2 "Positive and negative reference frequencies".

Parameter *Repetition Frequency/Pulse Train* **252** shows the actual value of the repetition frequency input.

Output as percentage

In the case of a parameterization as repetition frequency, the read frequency value is also available as a percentage for the reference percentage channel. 0 ... 100% correspond to the signal frequency range 0 ... *Maximum Frequency* **419** at the repetition frequency input. The conversion is done using the following formula:

$$\text{Percentage value} = \frac{\text{Frequency value}}{\text{Maximum Frequency } \mathbf{419}} \times 100\%$$

7.6.7.3 Pulse train

At digital input IN2D (terminal X11.5), a pulse train (pulse sequence) signal can be defined as reference value. Parameter *Operation Mode IN2D* **496** must be set to "30 - Pulse Train".

For setting of the reference values, the following settings can be selected:

- *Reference Frequency Source 1* **475** = "10 - Repetition Frequency".
- *Reference Frequency Source 2* **492** = "10 - Repetition Frequency".

654 Pulse Train Scaling Frequency

The pulse train (pulse sequence) signal at digital input IN2D (terminal X11.5) is scaled. Via parameter *Pulse Train Scaling Frequency* **654**, you can set which input frequency corresponds to the value of *Maximum Frequency* 419. A read frequency of *Maximum Frequency* 419 means that at the pulse train input, a frequency with the value of the scaling factor is applied.

Parameters		Setting		
No.	Description	Min.	Max.	Fact. sett.
654	Pulse Train Scaling Frequency	0	32000	25000

If parameter *Pulse Train Scaling Frequency* **654** is set to zero, the frequency value at the digital input will not be scaled.

Parameter *Repetition Frequency/Pulse Train* **252** shows the actual value of pulse train input.

Pulse train signal on IN2D as reference value:

<i>Reference Frequency Source 1</i> 475 or <i>Reference Frequency Source 2</i> 492	10 - Repetition Frequency
<i>Operation mode IN2D</i> 496	30 - Pulse Train
<i>Pulse Train Scaling Frequency</i> 654	The scaled pulse train signal is the reference frequency value.

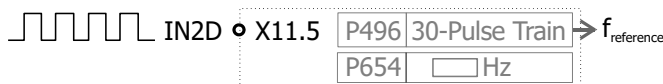

Reference frequency value:

$$f_{reference} = f_{IN2D} \times \frac{\text{Maximum Frequency } \mathbf{419}}{\text{Pulse Train Scaling Frequency } \mathbf{654} \text{ [Hz]}}$$

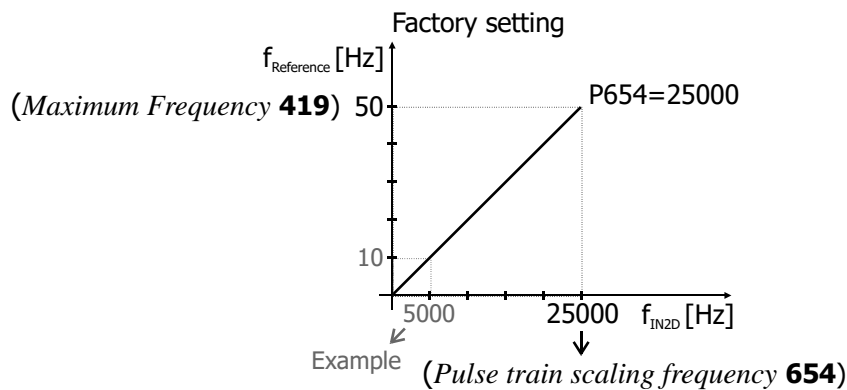

Example:

Input frequency at IN2D: $f_{IN2D} = 5000$ Hz

Reference frequency value:

<i>Pulse Train Scaling Frequency</i> 654	= 0	$f_{reference} = f_{IN2D}$ (5000 Hz), limited to 50 Hz (<i>Maximum Frequency</i> 419)
	= 25000	$f_{reference} = 10$ Hz

Output as percentage

In the case of a parameterization as a pulse train, the read frequency value is also available as a percentage for the reference percentage channel. 0 ... 100% correspond to the signal frequency range 0 ... *Maximum Frequency* **419** at the pulse train input. The conversion is done using the following formula:

$$\text{Percentage value} = \frac{\text{Frequency value}}{\text{Maximum Frequency } \mathbf{419}} \times 100\%$$

7.6.7.4 Further setting options

An offset can be set via the reference frequency channel or via the function of the electronic gear. For example, you can set in the reference frequency channel: *Reference Frequency Source 1* **475** = "10 - Repetition Frequency" and *Reference Frequency Source 2* **492** = "3 - Fixed Frequency". Via the fixed frequencies (parameters 480 ... 488), you can set the required offset.

A filter can be set via PLC-function (see application manual "PLC").

7.7 V/f characteristic

606 Type V/f characteristic

Via parameter *Type V/f Characteristic* **606**, you can set the characteristic to linear or quadratic.

Type	Function
1 - Linear	Linear V/f characteristic: $ U \sim f$. Factory setting.
2 - Quadratic	Quadratic V/f characteristic: $ U \sim f^2$. For applications where the torque increases quadratically to the speed. Suitable for energy saving. See chapter 8.2 "Quadratic V/f characteristic". Too small set values of the V/f characteristic affect the dynamic behaviour of the drive.

7.8 Linear V/f characteristic

600 Starting Voltage

601 Voltage Rise

602 Rise Frequency

603 Cut-Off Voltage

604 Cut-Off Frequency

The sensorless control in configuration 110 (parameter *Configuration* **30**) is based on the proportional change of output voltage compared to the output frequency according to the configured characteristic. By setting the V/f-characteristic, the voltage of the connected 3-phase motor is controlled according to the frequency. The torque to be applied by the motor at the corresponding operating point demands the control of the output voltage proportional to the frequency. At a constant output voltage/output frequency ratio of the frequency inverter, the magnetization is constant in the nominal operating range of the 3-phase motor. The rating point of the motor or end point of the V/f-characteristic is set via the guided commissioning with the parameter *Cut-Off Voltage* **603** and the parameter *Cut-Off Frequency* **604**.

The lower frequency range, where an increased voltage is necessary for the start of the drive, is critical. The voltage at an output frequency of zero is set with parameter *Starting Voltage* **600**. A voltage increase deviating from the linear course of the V/f-characteristic can be defined by parameters *Voltage Rise* **601** and *Rise Frequency* **602**. The parameter value percentage is calculated from the linear V/f-characteristic. Via the parameters *Minimum Frequency* **418** and *Maximum Frequency* **419**, the working range of the motor or the V/f-characteristic is defined.

Linear characteristic in setting "1 - Linear" for *Type V/f Characteristic* **606**.

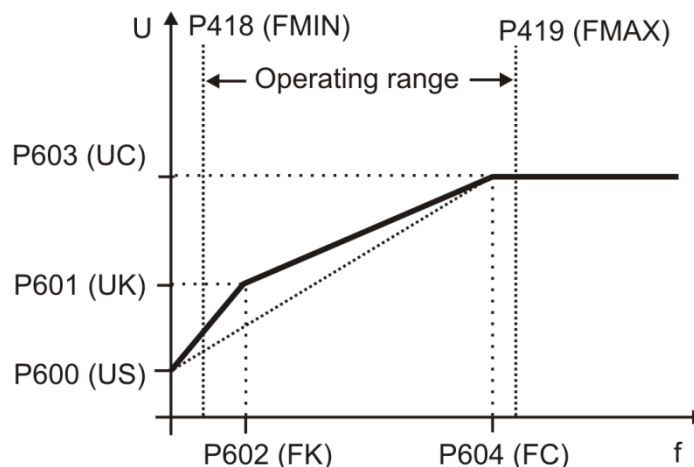

(FMIN): *Minimum Frequency* **418**, (FMAX): *Maximum Frequency* **419**,

(US): *Starting Voltage* **600**,

(UK): *Voltage Rise* **601**, (FK): *Rise Frequency* **602**

(UC): *Cut-Off Voltage* **603**, (FC): *Cut-Off Frequency* **604**

Parameters		Setting			
No.	Description	Min.	Max.	Fact. sett.	
600	Starting Voltage	0.0 V	100.0 V	5.0 V	
601	Voltage Rise	-100%	200%	10%	
602	Rise frequency	0%	100%	20%	
603	Cut-Off Voltage	KFU A2	30.0 V	280.0 V	230.0 V
		KFU A4	60.0 V	560.0 V	400.0 V
604	Cut-Off Frequency	0.00 Hz	599.00 Hz	50.00 Hz	



The guided commissioning takes the parameterized rated motor values and reference data of the frequency inverter into account when it comes to pre-setting the V/f-characteristic. In the case of asynchronous machines, the speed can be increased at a constant torque if the motor winding can be switched over from star to delta connection. If the data for delta connection indicated on the rating plate of the asynchronous motor were entered, the cut-off frequency is increased automatically by the square root of three.

The *Cut-Off Voltage* **603** (UC) and *Cut-Off Frequency* **604** (FC) set in the factory are derived from the motor data *Rated Voltage* **370** and *Rated Frequency* **375**. With the parameterized *Starting Voltage* **600** (US), the linear equation of the V/f-characteristic results.

$$U = \left(\frac{UC - US}{FC - 0} \right) \cdot f + US = \left(\frac{400.0 \text{ V} - 5.0 \text{ V}}{50.00 \text{ Hz} - 0.00 \text{ Hz}} \right) \cdot f + 5.0 \text{ V}$$

The *Rise Frequency* **602** (FK) is entered as a percentage of the *Cut-Off Frequency* **604** (FC), the default value is $f = 10 \text{ Hz}$. The output voltage for the default *Voltage Rise* **601** is calculated as $U = 92.4 \text{ V}$.

$$U = \left[\left(\frac{UC - US}{FC - 0} \right) \cdot (FK \cdot FC) + US \right] \cdot (1 + UK) = \left[\left(\frac{400 \text{ V} - 5 \text{ V}}{50 \text{ Hz} - 0 \text{ Hz}} \right) \cdot (0.2 \cdot 50 \text{ Hz}) + 5 \text{ V} \right] \cdot 1.1 = \underline{\underline{92.4 \text{ V}}}$$

7.8.1 Dynamic voltage pre-control

605 Dyn. Voltage Pre-Control

The *Dyn. Voltage Pre-Control* **605** accelerates the control behaviour of the current limit controller (parameter *Operation Mode* **610**) and of the voltage controller (parameter *Operation Mode* **670**). The output voltage value resulting from the V/F characteristic is changed by addition of the calculated voltage pre-control.

Parameters		Setting		
No.	Description	Min.	Max.	Fact. sett.
605	Dyn. Voltage Pre-Control	0%	200%	100%

7.9 Control functions

With the control function the control reactions can be set up fitting to the application.

7.9.1 Intelligent current limits

573 Operation Mode (intelligent current limits)

The current limits to be set according to the application avoid inadmissible loading of the connected load and prevent a fault switch-off of the frequency inverter. The function extends the current controller available in the control system. The overload reserve of the frequency inverter can be used optimally by means of the intelligent current limits, in particular in applications with dynamic load alternations. Parameter *Operation Mode* **573** defines the threshold to the activation of the intelligent current limit. The parameterized rated motor current or the reference current of the frequency inverter is synchronized as the limit value of the intelligent current limits.

In the control method according to V/f-characteristic (setting 110 of *Configuration 30*) the intelligent current limits take effect to the current limit controller. The intelligent current limits are active only in the case of an active current limit controller.

In the field-orientated control (setting 410 or 610 of *Configuration 30*) the maximum torque-forming current is limited by the intelligent current limits.

<i>Operation Mode 573</i>	Function
0 - Off	The function is switched off.
1 - Ixt	Limitation to the overload of the frequency inverter (Ixt).
10 - Tc	Limitation to the maximum heat sink temperature (Tc).
11 - Ixt + Tc	Operation mode 1 and 10 (Ixt + Tc).
20 - Motor Temp.	Limitation to the motor temperature (T _{Motor}).
21 - Motor Temp.+ Ixt	Operation mode 20 and 1 (T _{Motor} + Ixt).
30 - Tc + Motor Temp.	Operation mode 10 and 20 (Tc + T _{Motor}).
31 - Tc + Motor Temp. + Ixt	Operation mode 10 and 20 (Tc + T _{Motor} + Ixt). Factory setting.

In the operation modes with overload reserve (Ixt) there is a reduction of the output current when the threshold value is exceeded, with a distinction being made between long and short-term overload reserve. After the short-term overload (1 s) has been used up, the output current is reduced to the long-term overload current matching the present switching frequency. After the long-term overload current has been used up (60 s), the output current is reduced to the rated current which also depends on the switching frequency.

If the output current has already been reduced due to the fact that the long-term overload has used up, the short-term overload is no longer available even if it has not been used up beforehand. The defined overload reserve (Ixt) of the frequency inverter is available again after a power reduction lasting 10 minutes.

574 Power Limit

575 Limitation Time

The threshold selected via parameter *Operation Mode 573* is monitored. If parameter *Operation Mode 573* is selected to motor or heat sink temperature monitoring, the power is reduced to the value of *Power Limit 574* once the limit value is reached. The power is reduced until the temperature has dropped sufficiently. You can set an additional time *Limitation Time 575* for which the limitation after falling below the limit value should be maintained. In motor operation, the output current and the speed will be reduced. The load behaviour of the motor must depend on the speed.

The power limit should be selected as small as possible in order to give the drive sufficient time to cool down. The reference value is the rated output of the frequency inverter or the set rated power of the motor.

Parameters		Setting		
No.	Description	Min.	Max.	Fact. sett.
574	Power Limit	40.00%	95.00%	80.00%
575	Limitation Time	5 min	300 min	15 min

Output signals

Reaching of a limit – selected in *Operation Mode 573* – can be signalled via digital outputs.

15 -	Warning Current Limitation	The intelligent current limits limit the output current.
16 -	Controller Current Limit. Long Term Ixt	The overload reserve for 60 s has been used up and the output current is being limited.
17 -	Controller Current Limit. Short Term Ixt	The overload reserve for 1 s has been used up and the output current is being limited.
18 -	Controller Current Limit. Tc	Max. heat sink temperature T_k reached. The intelligent current limits are active.
19 -	Controller Current Limit. Motor Temp.	Max. motor temperature reached. The intelligent current limits are active.

7.9.2 Voltage controller

670 Operation Mode (voltage controller)

The voltage controller contains the functions necessary for monitoring the DC link voltage.

- The DC link voltage which rises in generator operation (in example during the braking process) of the motor is controlled to the set limit value by the voltage controller.
- The power failure regulation uses the rotation energy of the drive to bridge short-term power failures.

The voltage controller is set with parameter *Operation Mode 670*.

Operation mode 670	Function
0 - Off	The function is switched off. Brake and Motor chopper are active and switch with the parameterized thresholds of P506 and P507.
1 - Udc-Limitation active	DC link limitation active. Overvoltage controller switched on, the Brake and Motor chopper are active and switch with the parameterized thresholds of P506 and P507. Factory setting.
2 - Mains Support active	Power failure regulation switched on. Brake and Motor chopper are active and switch with the parameterized thresholds of P506 and P507. Suitable for quick shutdown.
3 - Udc-Limit. & Mains Supp. active	Overvoltage controller and power failure regulation switched on, with motor chopper.
12 - Mains Support active, Chopper not active	Power failure regulation switched on. During the Mains Support, motor and brake chopper are deactivated. In all other cases motor and brake chopper are active and switch with the parameterized thresholds of P506 and P507.
13 - Udc-Limit. & Mains Supp. active, Chopper not active	Overvoltage controller and power failure regulation switched on. During the Mains Support, motor and brake chopper are deactivated. In all other cases motor and brake chopper are active and switch with the parameterized thresholds of P506 and P507.

The function motor chopper is available only in the field-orientated control methods in configuration 410 (parameter *Configuration 30*).

When an operation mode with motor chopper is selected, set the *Trigger Threshold 507* < (*Reference DC-Link Limitation 680* - 10 V). See chapter 7.10.5 "Motor chopper".



For synchronous motors (*Configuration 30* = 610), the motor chopper function is deactivated to prevent damages to the motor. The other functions of the voltage controller are not affected by this.

For asynchronous motors in V/f control (*Configuration 30* = 110), the motor chopper function is not operative. The other functions of the voltage controller are not affected by this.



The brake chopper is active dependent of the setting of *Reference DC-Link Limitation 680*. See chapter 7.10.4 "Brake chopper and brake resist" for parameterizing the switching threshold.

**Operation mode overvoltage control,
Voltage controller: Parameter *Operation Mode* 670 = 1**

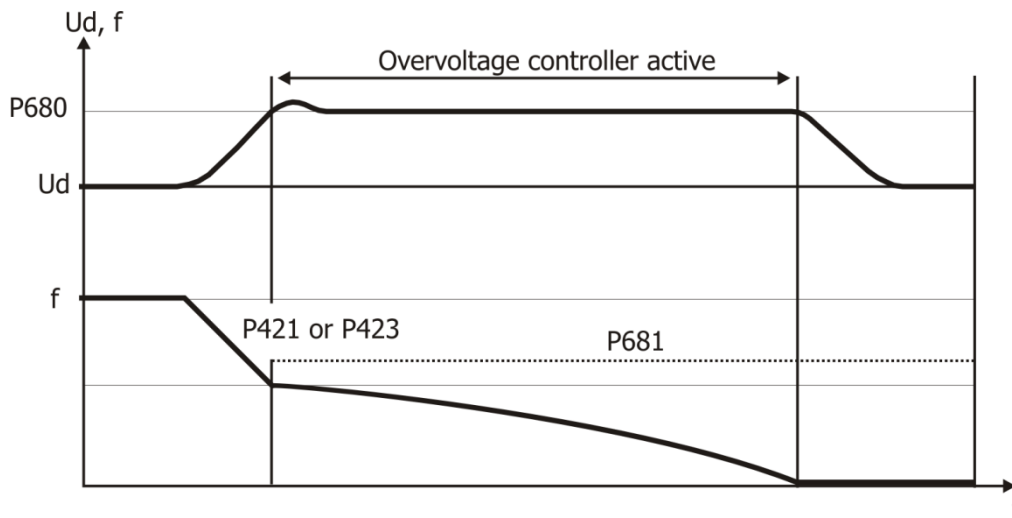

680 Reference DC-Link Limitation

681 Max. Frequency Rise

The overvoltage controller prevents a switch-off of the frequency inverter in generator operation. The reduction of the drive speed by a ramp gradient selected via parameter *Deceleration Clockwise* **421**, or *Deceleration Anticlockwise* **423** can lead to an overvoltage in the DC link. If the voltage exceeds the figure set by the parameter *Reference DC-Link Limitation* **680**, the deceleration is reduced in such a way that the DC link voltage is regulated to the set value. If the DC link voltage cannot be regulated to the set reference value by the reduction of the deceleration, the deceleration is stopped and the output frequency raised. The output frequency is calculated by addition of the parameter value *Max. Frequency Rise* **681** to the frequency at the operating point of the controller intervention.

Parameters			Setting		
No.	Description		Min.	Max.	Fact. sett.
680	Reference DC-Link Limitation	KFU A2	225.0 V	387.5 V	380.0 V
		KFU A4	325.0 V	775.0 V	760.0 V
681	Max. Frequency Rise		0.00 Hz	599.00 Hz	10.00 Hz

For a reliable operation of the overvoltage controller, KÜENLE ANTRIEBSSYSTEME recommends to set the motor-chopper *Trigger Threshold* **507** < (*Reference DC-Link Limitation* **680** - 10 V). See chapter 7.10.5 "Motor chopper".

Operation mode power failure regulation.
Voltage controller: Parameter *Operation mode* 670 = 2
without Mains resumption

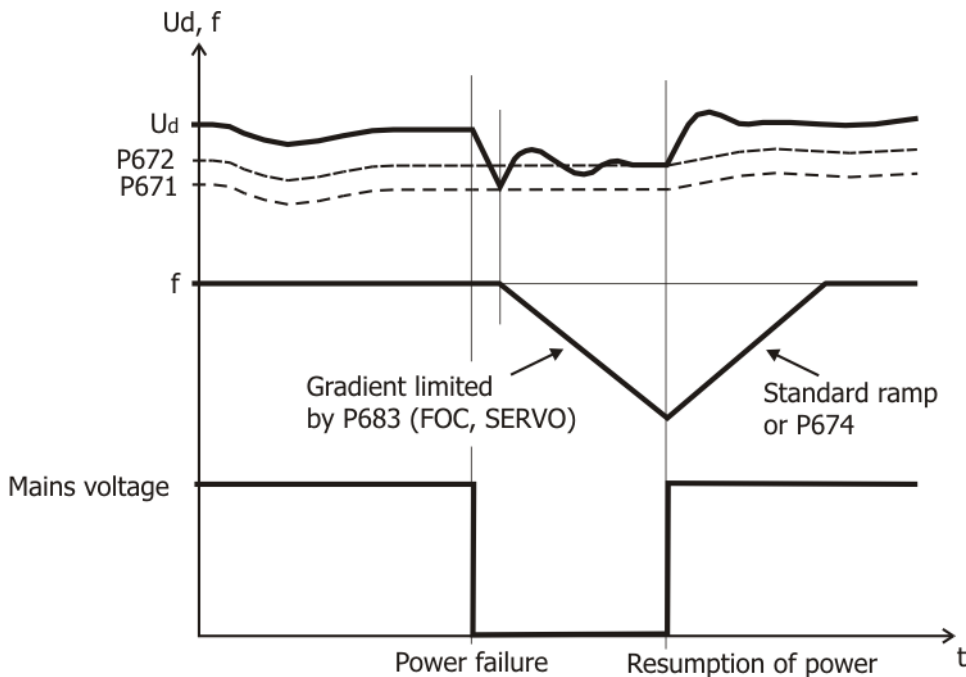

671 Mains Failure Threshold

672 Reference Mains Support Value

With the power failure regulation, short-term power failures can be bridged. Mains failure is detected when the DC link voltage has dropped below the set value of parameter *Mains Failure Threshold* **671**. If a mains failure is detected, the controller tries to regulate the DC link voltage to the value set with parameter *Reference Mains Support Value* **672**. To that end, the output frequency is continuously reduced and the motor with its rotating masses is switched over to generator operation. Using field oriented Control (FOC, SERVO) the reduction of the output frequency is done according to the configuration with a maximum of the current set by the parameter *Gen. Ref. Current Limit* **683**.



Gen. Ref. Current Limit **683** is active in configurations 410 and 610 (FOC and SERVO).

The threshold values of the voltage controller are calculated starting with the current DC link voltage with the parameters *Mains Failure Threshold* **671** and *Reference Mains Support Value* **672**.

If the mains voltage is restored before a switch-off is effected by the mains undervoltage detection system, the drive is accelerated to its reference frequency at the set acceleration or according to the parameter *Acceleration on Mains Resumption* **674**. If the value of parameter *Acceleration on Mains Resumption* **674** is set to the default value of 0.00 Hz/s, the drive is accelerated at the values set for the ramp parameters *Acceleration (Clockwise)* **420** or *Acceleration Anticlockwise* **422**.

Parameters		Setting		
No.	Description	Min.	Max.	Fact. sett.
671	Mains Failure Threshold	-200.0 V	-50.0 V	-100.0 V
672	Reference mains support value	-200.0 V	-10.0 V	-40.0 V



The frequency inverter reacts to the signals at the control inputs both when the power failure regulation is switched on and in normal operation. A control via externally supplied control signals is only possible in the case of a no-break supply. As an alternative, supply of the control signals through the frequency inverter is to be used.

Output signals

Mains failure and mains support are signalled via digital signals.

179 - Mains failure	¹⁾	Failure of mains voltage and mains support– selected via <i>Operation Mode</i>
13 - Mains failure	²⁾	670 of the voltage controller.

¹⁾ For linking to frequency inverter functions.

²⁾ For output via a digital output. Select the signal source for one of the parameters 531, 532, 533, 554. See chapter 7.6.5 "Digital outputs".

Operation mode power failure regulation Voltage controller: Parameter *Operation mode* 670 = 2 with Mains resumption

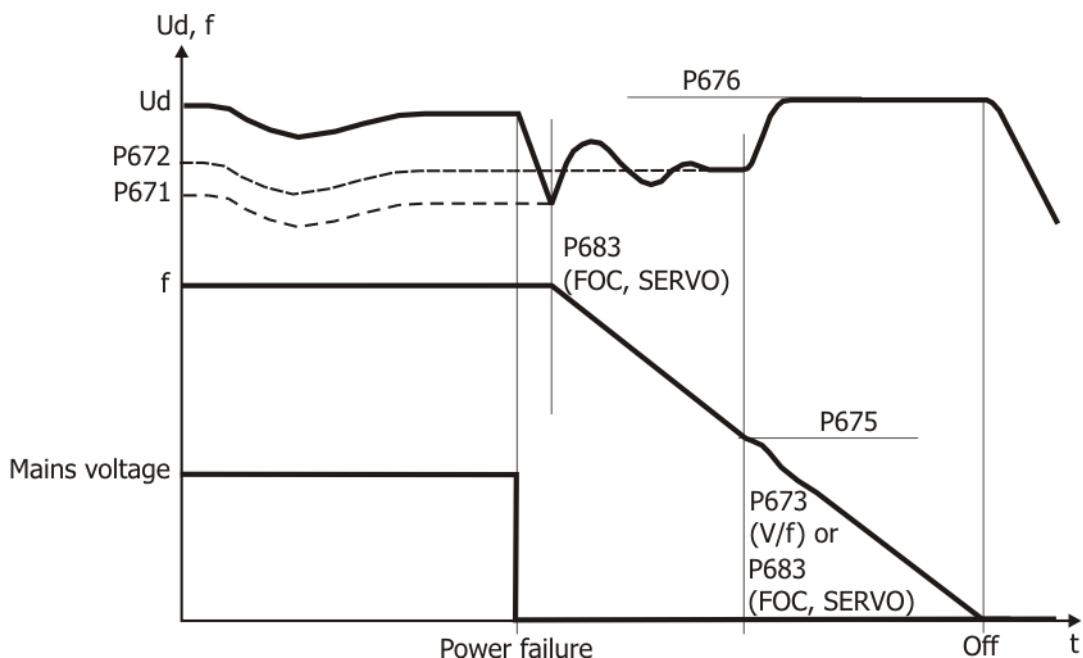

675 Shutdown Threshold

676 Reference Shutdown Value

The DC link voltage which is available in the case of a power failure is supplied by the motor. The output frequency is continuously reduced and the motor with its rotating masses is switched over to generator operation. The reduction of the output frequency is done with a maximum of the current set by the parameter *Gen. Ref. Current Limit* **683** or the ramp *Mains Support Deceleration* **673**. *Mains Support Deceleration* **673** is only active if the Actual frequency is smaller than *Shutdown Threshold* **675**.

The time required until the motor has come to a standstill results from the regenerative energy of the system which results in an increase in the DC link voltage. The DC link voltage set with the parameter *Reference Shutdown Value* **676** is used by the voltage controller as a control figure and kept constant. The voltage rise enables optimization of the braking behaviour and the time until the drive has come to a standstill. The behaviour of the controller can be compared to stopping behaviour 2 (Shutdown and Stop), as the voltage controller brings the drive to a standstill at the maximum deceleration ramp and supplies it with the remaining DC link voltage.

If the DC-link voltage is restored before the shutdown of the drive, but after falling below *Shutdown Threshold* **675**, the drive is still decelerated to standstill.

If the mains voltage is restored after the shutdown of the drive but before the undervoltage switch-off has been reached, the frequency inverter signals a fault. The operator panel displays the fault message "F0702".

If the mains failure without shutdown (*Shutdown Threshold 675* = 0 Hz) takes so long that the frequency has been reduced to 0 Hz, the drive is accelerated to the reference frequency when the mains supply is restored.

If the mains failure with or without shutdown takes so long that the frequency inverter shuts off completely, the frequency inverter will be in the "Standby" state when the mains supply is restored. If the inverter is enabled again, the drive will start. If the drive is to start automatically after restoration of the mains supply if the inverter is enabled permanently, *Operation Mode 651* of auto start must be switched on.

Parameters		Setting			
No.	Description	Min.	Max.	Fact. sett.	
675	Shutdown Threshold	0.00 Hz	599.00 Hz	0.00 Hz	
676	Reference Shutdown Value	KFU A2	225.0 V	375.5 V	365.0 V
		KFU A4	425.0 V	775.0 V	730.0 V



Reference Shutdown Value 676 becomes effective below the frequency value *Shutdown Threshold 675*.

673 Mains Support Deceleration

674 Acceleration on Mains Resumption

683 Gen. Ref. Current Limit

The voltage controller uses the limit values of the DC link voltage. If the default value is changed, the *Acceleration on Mains Resumption 674* replaces the set ramp parameter values *Acceleration (Clockwise) 420* or *Acceleration Anticlockwise 422*. The voltage control in a mains failure changes from the frequency limit *Shutdown Threshold 675* from *Reference Mains Support Value 672* to the *Reference Shutdown Value 676*. The value of *Gen. Ref. Current Limit 683* or the ramp *Mains Support Deceleration 673* defines the maximum deceleration of the drive required in order to reach the voltage value *Reference Shutdown Value 676*. *Mains Support Deceleration 673* is only active if the Actual frequency is smaller than *Shutdown Threshold 675*.

Parameters		Setting		
No.	Description	Min.	Max.	Fact. sett.
683	Gen. Ref. Current Limit	0.0 A	$0_c \cdot I_{FIN}$	I_{FIN}
673	Mains Support Deceleration	0.01 Hz/s	9999.99 Hz/s	50.00 Hz/s
674	Acceleration on Mains Resumption	0.00 Hz/s	9999.99 Hz/s	0.00 Hz/s

I_{FIN} : Nominal value of frequency inverter

0_c : Overload capacity of frequency inverter



Mains Support Deceleration 673 is active in configuration 110 (V/f).

Gen. Ref. Current Limit 683 is active in configurations 410 and 610 (FOC and SERVO).

677 Amplification

678 Integral Time

The proportional and integrating part of the voltage controller can be set via parameters *Amplification* **677** and *Integral Time* **678**. The control functions are deactivated by setting the parameters to 0. The controllers are P and I controllers in the corresponding settings.

Parameters		Setting		
No.	Description	Min.	Max.	Fact. sett.
677	Amplification	0.00	30.00	1 ¹⁾
				2 ²⁾
678	Integral Time	0 ms	10000 ms	8 ms ¹⁾
				23 ms ²⁾

The factory settings depend on the selected configuration and control procedure.

¹⁾Configuration **30** = 110

²⁾Configuration **30** = 410, 610

7.9.3 PID controller (technology controller)

The PID controller can be used for process control. The connection of PID desired set value and PID real value of the application with the functions of the frequency inverter enables process control without further components. In this way, applications such as pressure, volume flow or speed control can be implemented easily.

Starting the PID controller: Set one of the following parameters.

Parameters	Factory setting	Set
<i>Reference Frequency Source 1</i> 475	1 - Analog Value MFI1A	30 - Technology Controller
or		
<i>Reference Frequency Source 2</i> 492	5 - Keypad-Motorpot.	30 - Technology Controller

Desired set value for PID controller: Set one of the following parameters.

Parameters	Factory setting	Set
<i>Reference Percentage Source 1</i> 476	1 - Analog Value MFI1A ¹	Select analog input or percentage. For example "2 - Analog Value MFI2A" ² or "3 - Fixed Percentage".
or		
<i>Reference Percentage Source 2</i> 494	5 - Keypad-Motorpot.	

For example: analog desired set value at MFI2A.

(*Reference Percentage Source 1* **476** or *Reference Percentage Source 2* **494** = "2 - Analog Value MFI2A")

Set terminal X12.4 as analog input.

Parameters	Factory setting	Set
<i>Operation Mode MFI2</i> 562	4 - Digital PNP (active: 24 V)	Voltage input or current input. See chapter 7.6.1.2.

¹ MFI1A: Multifunction input at terminal X12.3.

² MFI2A: Multifunction input at terminal X12.4.

For example: The desired set value is a fixed percentage.

Reference Percentage Source 1 **476** or *Reference Percentage Source 2* **494** = "3 - Fixed Percentage")

Set and select fixed percentage.

Parameters	Factory setting	Set
Parameters 520, 521, 522, 523 (fixed percentages) <i>Fixed Percent Change-Over 1</i> 75 and <i>Fixed Percent Change-Over 2</i> 76	0%, 20%, 50%, 100% 7 - Off	Enter a value. See chapter 7.5.2.3 "Fixed percentages". Select digital inputs or logic signals. See chapter 7.6.6.6 "Fixed percentage changeover".

Real value for PID controller

Parameters	Factory setting	Set
<i>Actual Percentage Source</i> 478	1 - Analog Input MF11A	Select input where PID real value is applied.

For example: analog PID real value at MF11A. Set terminal X12.3 as analog input.

Parameters	Factory setting	Set
<i>Operation Mode MF11</i> 452	1 - Voltage 0...10 V	Voltage input or current input. See chapter 7.6.1 "Multifunction input MF11".

For the adjustment to the application, setting the minimum and maximum frequency may be required:

Parameters	Factory setting
<i>Minimum Frequency</i> 418	3.50 Hz
<i>Maximum Frequency</i> 419	50.00 Hz

The values of the set ramps (parameters 420 to 426 and 430) are considered if the PID controller is used.

The technology controller can be started via the signals of parameters *Start Clockwise* **68** or *Start Anticlockwise* **69**.

The control deviation (difference between reference percentage and actual percentage) is signaled to the PID controller. The PID controller adjusts the output frequency of the frequency inverter such that the control deviation is minimized.

P controller: The output of the P controller is the product of the control deviation and the amplification and follows the control deviation linearly and without delay. A control deviation will be maintained.

I controller: The output of the I controller is the integral of the control deviation. The task of the I controller is to eliminate the control deviation. The integral time defines how fast the control deviation is compensated. If the I controller is set too dynamically (fast compensation of deviations), the system may become unstable and vibrate. If the I controller is set too passively (slow compensation of deviations), the stationary error is not compensated sufficiently. For this reason, the integral portion must be adjusted plant-specifically.

D controller: The D controller assesses the change of the control deviation and calculates its change rate. This value is multiplied by the derivative time. The D controller responds to announced changes and causes a fast control behaviour. The D controller can stabilize the control circuit and reduce vibration. On the other hand, errors (e.g. interference voltages) are amplified.

In order to use the output value of the PID controller as the reference frequency, setting "30 - Technology Controller" must be selected for *Reference Frequency Source 1* **475** or *Reference Frequency Source 2* **492**. If the technology controller is selected as the reference frequency source, the settings of the PID controller are activated.

The behaviour of the PID controller is set with:

- Proportional part *Amplification 444*
- Integral part *Integral Time 445*
- Differential part *Derivative Time 446*

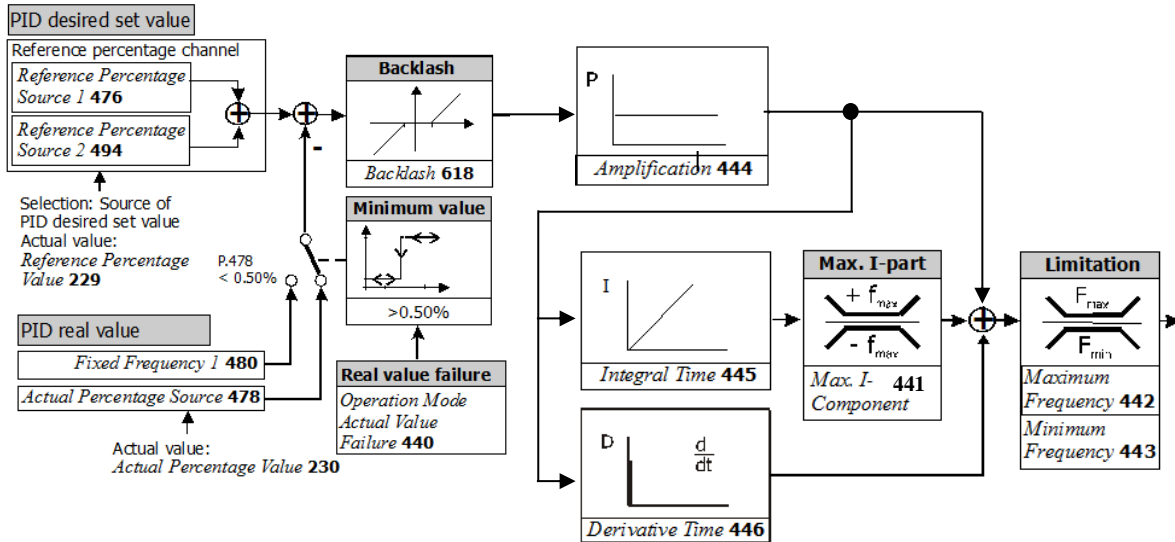

Reference percentage channel is shown (simplified). See chapter 7.5.2 "Reference percentage channel".

APPLICATION EXAMPLES

Application	Function
Pressure control	The pressure in a process is kept at a constant level by means of a pressure sensor.
Flow rate control	The flow rate in a process is kept at a constant level by means of a flow sensor.
Temperature control	The temperature is kept at a constant level by controlling a fan by means of a thermostat.

Via dataset changeover via control contacts, the PID controller can be adjusted to different operating points.

476,494 Reference percentage source, PID desired set value input

The desired set value source of the control can be selected via parameter *Reference Percentage Source 1 476* or *Reference Percentage Source 2 494*. The values of both parameters are added. See chapter 7.5.2 "Reference percentage channel".

478 Actual Percentage Source, PID real value input

The analog input or the repetition frequency input to which the PID real value is applied can be selected via parameter *Actual Percentage Source* **478**. The actual value can also be transmitted via a bus system.

<i>Actual Percentage Source</i> 478	Function
1 - Analog Input MF11A	Analog signal at multifunction input 1 (terminal X12.3). Factory setting. Via parameter <i>Operation mode MF11</i> 452 , the input must be set up as an analog input (voltage or current). See chapter 7.6.1 "Multifunction input MF11".
2 - Analog Input MF12A	Analog signal at multifunction input 2 (terminal X12.4). Via parameter <i>Operation mode MF12</i> 562 , the input must be set up as an analog input (voltage or current). See chapter 7.6.1.2.
32 - Rep. Percentage Input	Percentage signal at digital input IN2D. Evaluation can be selected via parameter <i>Operation mode IN2D</i> 496 . See chapter 7.6.7.1.
40 - Actual Percentage RAM	Value of parameter <i>Actual Percentage RAM</i> 529 . <i>Actual Percentage RAM</i> 529 can be set via Fieldbus, but is not visible in VPlus or the keypad.
704 - RxPDO1 Word 1	Process data from system bus. Refer to system bus instructions.
705 - RxPDO1 Word 2	Process data from system bus. Refer to system bus instructions.
2521 - PLC-Output Percentage 1	Output value of a PLC-function. Percentage output 1 of the table function is the PID real value source. See application manual "PLC".
2522 - PLC-Output Percentage 2	Output value of a PLC-function. Percentage output 2 of the table function is the PID real value source. See application manual "PLC".

INPUTS FOR REFERENCE PERCENTAGE SOURCE

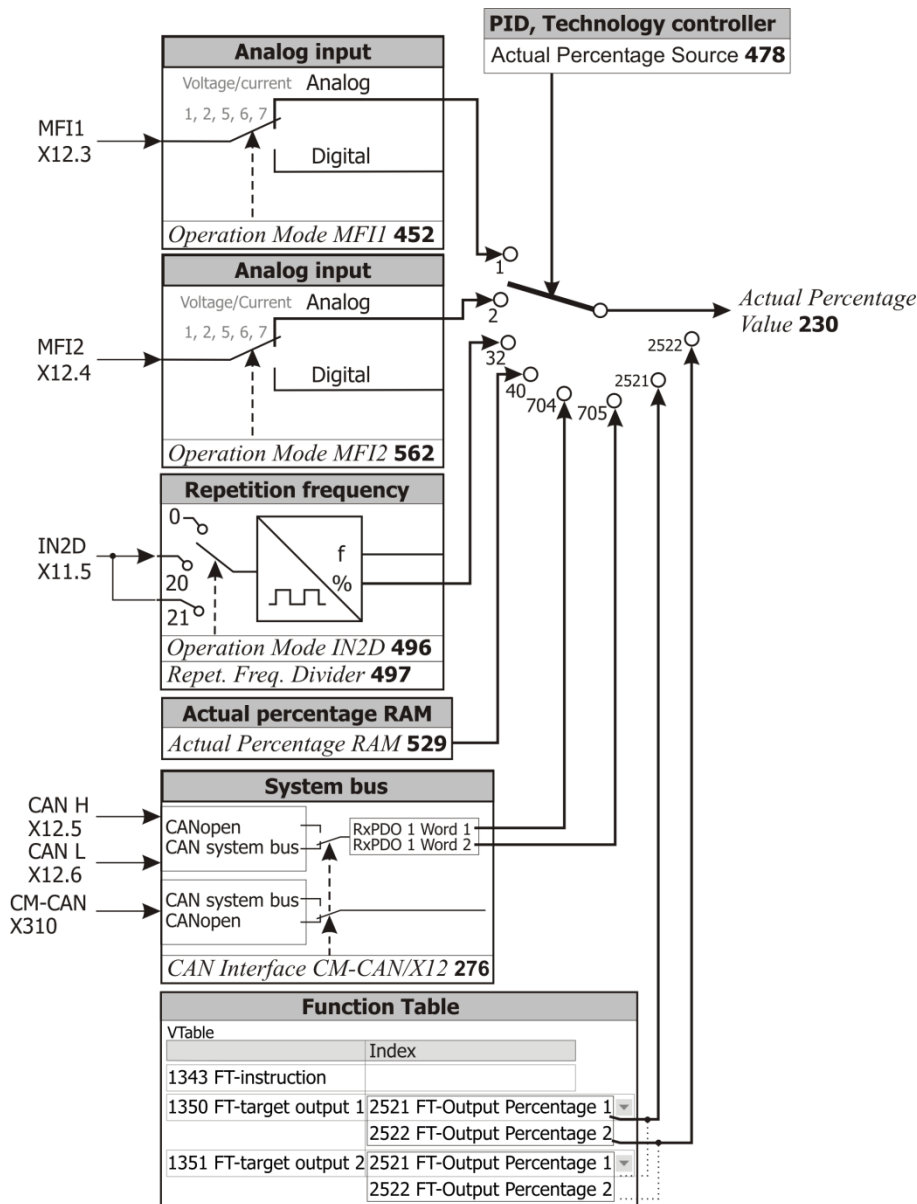

440 Operation Mode Actual Value Failure

Via parameter *Operation Mode Actual Value Failure* **440**, you can set how the frequency inverter will respond to a missing PID real value (<0.5%). In this way, the drive can be prevented from starting if a PID real value is missing. The function enables, for example, monitoring of a sensor cable for broken wires. The function should be switched on in order to avoid critical operating behaviour, e.g. acceleration to maximum frequency if the actual value signal fails.

Operation mode 440	Function
0 - Off	No response if PID real value is missing. Missing PID real values (<0.5%) will be evaluated as PID real values.
1 - Active, Fixed Frequency 1	If the PID real value is missing, the output frequency is guided to the value of <i>Fixed Frequency 1</i> 480 . Factory setting.
10 - Active, Stop + Error	If the PID real value is missing, the drive will be shut down and error F1409 "actual value is missing" will be signaled.
20 - Active, Error	If the PID real value is missing, error F1409 "actual value is missing" will be signaled.

480 Fixed Frequency 1 (in case of missing PID real value)

If the PID real value is missing (<0.5%), the output frequency is guided to the value of *Fixed Frequency 1 480*. The minimum value prevents an acceleration of the drive if the PID real value is missing. If the PID real value is available again, the controller continues operation automatically.

Parameters		Setting		
No.	Description	Min.	Max.	Fact. sett.
480	Fixed Frequency 1	-599.00 Hz	599.00 Hz	0.00 Hz

The *Fixed Frequency 1 480* must be in the range between *Minimum Frequency 418* and *Maximum Frequency 419*. If the *Fixed Frequency 1 480* is set to a value smaller than the *Minimum Frequency 418*, the output frequency is guided to *Minimum Frequency 418*. The frequency will not drop below *Minimum Frequency 418*.

444 Amplification (P)

Parameter *Amplification 444* defines the amplification factor by which the control deviation is multiplied. The control deviation can be reduced by large amplification values, but very high values may cause the control circuit to become unstable (vibrations). If the value is set too low, large control deviations are possible.

Parameters		Setting		
No.	Description	Min.	Max.	Fact. sett.
444	Amplification	-15.00	+15.00	1.00

The sign of the amplification defines the control direction, i.e. if the PID real value increases and the sign of the amplification is positive, the output frequency is reduced (e.g. pressure control). With a rising PID real value and negative sign of the amplification, the output frequency is increased (e.g. in temperature control systems, refrigerating machines, condensers).

445 Integral Time (I)

Parameter *Integral Time 445* defines the time constant for calculation of the integral of the PID input signal. The I controller totals the control deviation over time and divides the result by the value of *Integral Time 445*. If the *Integral Time 445* is set to small values, the control deviation is compensated quickly. Very low values for the *Integral Time 445* may cause the control circuit to become unstable (vibrations).

Parameters		Setting		
No.	Description	Min.	Max.	Fact. sett.
445	Integral Time	0 ms	32767 ms	200 ms

If parameter *Integral Time 445* is set to zero, the I controller is deactivated.

The amplification (P) is included in the calculation of the integral time (I), see figure PID controller.

KÜENLE recommends setting the *Integral Time 445* to a value greater than the sampling time, which is 2 ms in the case of the *KFU* device.

441 Max. I-Component

Parameter *Max. I-Component 441* defines the maximum output signal of the I-controller. In applications with quickly changing load torques, vibrations of the control circuit are possible. In order to avoid vibration, parameter *Max. I-Component 441* can limit the output signal of the I-controller.

Parameters		Setting		
No.	Description	Min.	Max.	Fact. sett.
441	Max. I-Component	0.00 Hz	599.00 Hz	50.00 Hz

446 Derivative time (D)

If the control behaviour of the PI controller (or P controller) is too slow, a faster control can be achieved by activating and adjusting the differential part (*Derivative time 446*). However, if the differential part is activated, the control circuit has a higher tendency toward vibration. For this reason, the differential part should be activated and changed carefully.

By default, the differential part is set to *Derivative time 446* = 0 ms, i.e. it is deactivated. High values for *Derivative time 446* cause fast control, but amplify interferences.

The amplification (P) is included in the calculation of the derivative time (D), see figure PID controller.

Parameters		Setting		
No.	Description	Min.	Max.	Fact. sett.
446	Derivative time	0 ms	1000 ms	0 ms

442 Maximum Frequency

443 Minimum Frequency

Parameters *Maximum Frequency 442* and *Minimum Frequency 443* define the working range of the controller. In this way, you can also define if the PID controller is to operate the drive in one direction only or if both directions of rotations are to be possible.

Parameters		Setting		
No.	Description	Min.	Max.	Fact. sett.
442	Maximum Frequency	0 Hz	599.00 Hz	50.00 Hz
443	Minimum Frequency	-599.00 Hz	0 Hz	-50.00 Hz



If the PID controller is to operate the drive in both directions, (*Minimum Frequency 443* < 0 Hz), Parameter *Minimum Frequency 418* should be set to 0 Hz.



If *Maximum Frequency 442* and *Minimum Frequency 443* are set asymmetric (in example *Maximum Frequency 442* = 30.00 Hz and *Minimum Frequency 443* = -20.00 Hz with positive *Amplification 444*), setting the Start-Right-Control will result in using *Maximum Frequency 442* for Clockwise rotation (positive control deviation) and *Minimum Frequency 443* for Anticlockwise rotation (negative control deviation).

Setting the Start-Left-Control will result in using *Minimum Frequency 443* for Clockwise rotation (positive control deviation) and *Maximum Frequency 442* for Anticlockwise rotation (negative control deviation).

618 Backlash

With parameter *Backlash 618*, you can set a range in which a control deviation is not processed. In this way, frequent post-controlling and jerking of the drive can be avoided.

Requirement: *Stator Frequency 210* < *Switch-Off Threshold Stop Function 637*.

Parameters		Setting		
No.	Description	Min.	Max.	Fact. sett.
618	Backlash	0%	30.00%	0%

616 Backlash Motor Power off

In different applications it could be requested to switch off the power stage with a small control deviation and low output frequency. With parameter *Backlash Motor Power off* **616** this behaviour can be set up.

<i>Backlash Motor Power off</i> 440	Function
0 - Off	The switch off of the power stage is not influenced. Factory setting.
1 - Active, Fixed Frequency 1	If the control deviation < <i>Backlash</i> 618 and at the same time the Actual Frequency < <i>Switch-Off Threshold Stop Function</i> 637 the power stage is switched off.



The Switch off behaviour, which is set up by the Stopping behaviour (*Operation mode* **630**) is not changed by *Backlash Motor Power off* **616**. While this function is switched on, the power stage is additionally switched off if the control deviation < *Backlash* **618** and Actual Frequency < *Switch-Off Threshold Stop Function* **637**. The motor is switched on again as soon as the control deviation is larger again than the set up threshold of *Backlash* **618**.

7.9.4 Functions of sensorless control

The configurations of the sensorless control contain the following additional functions, which supplement the behaviour according to the parameterized V/f characteristic (*Configuration* **30** = 110).

7.9.4.1 Slip compensation

660 Operation Mode (slip compensation)

The load-dependent difference between the reference speed and the actual speed of the 3-phase motor is referred to as the slip. This dependency can be compensated by the current measurement in the output phases of the frequency inverter.

The activation of *Operation Mode* **660** for the slip compensation enables as speed control without feedback. The stator frequency and speed are corrected depending on the load.

<i>Operation Mode</i> 660	Function
0 - Off	The slip compensation is deactivated. Factory setting.
1 - On	The load-dependent slip speed is compensated

The slip compensation is activated during the guided commissioning. The *Stator Resistance* **377** is required to ensure a correct function and is measured during the guided commissioning.

If no guided commissioning is executed, the slip compensation can be activated manually. In these cases, enter the value for the *Stator Resistance* **377** manually according to the motor data sheet.

For parameter *Configuration* **30**, setting "110 - IM: sensorless control" (V/f characteristic) must be selected.

661 Amplification

662 Max. Slip Ramp

663 Frequency Lower Limit

The control behaviour of the slip compensation can only be optimized via the parameters in the case of specific applications. The parameter *Amplification* **661** determines the correction of the speed and the effect of the slip compensation proportionally to the change of load. Parameter *Max. Slip Ramp* **662** defines the maximum frequency change per second in order to avoid an overload in the case of a load change.

The parameter *Frequency Lower Limit* **663** determines the frequency as from which the slip compensation becomes active.

Parameters		Setting		
No.	Description	Min.	Max.	Fact. sett.
661	Amplification	0%	300.0%	100.0%
662	Max. Slip Ramp	0.01 Hz/s	650.00 Hz/s	5.00 Hz/s
663	Frequency Lower Limit	0.01 Hz	599.00 Hz	0.01 Hz

7.9.4.2 Current limit value controller

610 Operation Mode (current limit value controller)

Via a load-dependent speed control, the current limit value controller ensures that the drive system is not overloaded. This is extended by the intelligent current limits described in the previous chapter. The current limit value controller reduces the load on the drive, e.g. during acceleration, by stopping the acceleration ramp. The switch-off of the frequency inverter which happens when the acceleration ramps have been set at an excessive gradient is thus prevented.

The current limit value controller is switched on and off via parameter *Operation Mode* **610**.

<i>Operation Mode 610</i>	Function
0 - Off	The current limit value controller functions and the intelligent current limits have been deactivated. Factory setting.
1 - On	The current limit value controller is active.

611 Amplification

612 Integral Time

The control behaviour of the current limit controller can be set via the proportional part, parameter *Amplification* **611** and the integrating part, parameter *Integral Time* **612**. If, in exceptional cases, optimization of the controller parameters is required, proceed with the following steps:

- Change parameter *Current Limit* **613** with a big step, analyze the changes in the Scope.
- For a more dynamic behaviour increase *Amplification* **611** and/or decrease *Integral Time* **612**.
- For a less dynamic behaviour decrease *Amplification* **611** and/or increase *Integral Time* **612**.

Parameters		Setting		
No.	Description	Min.	Max.	Fact. sett.
611	Amplification	0.01	30.00	1.00
612	Integral Time	1 ms	10000 ms	24 ms



The dynamism of the current limit value controller and the voltage controller is influenced by the setting of the parameter *Dyn. Voltage Pre-Control* **605**.

613 Current Limit

614 Frequency Limit

Behaviour in motor operation:

If the current set via parameter *Current Limit* **613** is exceeded, the activated current limit value controller will reduce the output frequency until the current limit is no longer exceeded. The output frequency is reduced as a maximum to the frequency set by the parameter *Frequency Limit* **614**. If the current value drops below the *Current Limit* **613**, the output frequency is raised back to the reference value.

Behaviour in generator operation:

If the current set via parameter *Current Limit* **613** is exceeded, the activated current limit value controller will increase the output frequency until the current limit is no longer exceeded. The output frequency is increased, as a maximum, to the set *Maximum Frequency* **419**. If the current is below the *Current Limit* **613**, the output frequency is reduced to the required reference value again.

Parameters		Setting		
No.	Description	Min.	Max.	Fact. sett.
613	Current Limit	0.0 A	$o_c \cdot I_{FIN}$	$o_c \cdot I_{FIN}$
614	Frequency Limit	0.00 Hz	599.00 Hz	0.00 Hz

I_{FIN} : Nominal value of frequency inverter

o_c : Overload capacity of frequency inverter

7.9.5 Functions of field-orientated control

The field-orientated control systems are based on a cascade control and the calculation of a complex machine model. In the course of the guided commissioning, a map of the connected machine is produced by the parameter identification and transferred to various parameters. Some of these parameters are visible and can be optimized for various operating points.

7.9.5.1 Current controller

700 Amplification

701 Integral Time

The current controller with the parameters *Amplification* **700** and *Integral Time* **701** is applicable for field-orientated control (setting 410 or 610 of parameter *Configuration* **30**).

In the control according to V/f-characteristic (setting 110 of parameter *Configuration* **30**) the current controller is only applicable for the function Flying Start (parameter *Operation Mode Flying Start* **645**).

The inner control loop of the field-orientated control comprises two current controllers. The field-orientated control thus impresses the motor current into the machine via two components to be controlled.

This is done by:

- controlling the flux-forming current value I_{sd}
- controlling the torque-forming current value I_{sq}

By separate regulation of these two parameters, a decoupling of the system equivalent to an externally excited direct current machine is achieved.

The set-up of the two current controllers is identical and enables joint setting of amplification as well as the integral time for both controllers. For this, the parameters *Amplification* **700** and *Integral Time* **701** are available. The proportional and integration and component of the current controllers can be switched off by setting the parameters to zero.

Parameters		Setting		
No.	Description	Min.	Max.	Fact. sett.
700	Amplification	0.00	8.00	0.13
701	Integral Time	0.00 ms	10.00 ms	10.00 ms

The guided commissioning has selected the parameters of the current controller in such a way that they can be used without having to be changed in most applications.

If, in exceptional cases, an optimization of the behaviour of the current controllers is to be done, the reference value jump during the flux-formation phase can be used for this. The reference value of the flux-forming current components leaps to the figure *Current during Flux-Formation* **781** with suitable parameterization and then changes controlled to the magnetizing current after the expiry of the *Max. Flux-Formation Time* **780**. The operating point necessary for the adjustment demands the setting of parameter *Minimum Frequency* **418**, as the drive is accelerated after magnetizing. The measurement of the jump reply, which is defined by the ratio of the currents mentioned, should be done in the motor supply line by means of a measuring current transformer of a sufficient bandwidth.



The internally calculated actual value for the flux-forming current component cannot be output via the analog output for this measurement as the time resolution of the measurement is not sufficient.

To set the parameters of the PI controller, the *Amplification 700* is increased first until the actual value overshoots distinctly during the control process. Now, the amplification is reduced to about fifty percent again and then the *Integral Time 701* is synchronized until actual value overshoots slightly during the control process.

The settings of the current controllers should not be too dynamic in order to ensure a sufficient reserve range. The control tends to increased oscillations if the reverse range is reduced.

The dimensioning of the current controller parameters by calculation of the time constant is to be done for a switching frequency of 2 kHz. For other switching frequencies, the values are adapted internally so that the setting can remain un-changed for all switching frequencies. The dynamic properties of the current controller improve if the switching and scanning frequency increases.

The fixed time interval for the modulation results in the following scanning frequencies of the current controller via parameter *Switching Frequency 400*.

Setting	
Switching frequency	Scanning frequency
2 kHz	2 kHz
4 kHz	4 kHz
8 kHz	8 kHz
16 kHz	8 kHz

746 Cross-Coupling Factor

For an asynchronous motor (*Configuration 30* = 410) and synchronous motor (*Configuration 30* = 610), the coupling between the flux-forming current I_{sd} and the torque-forming current I_{sq} can be undone largely by the activated cross-coupling compensation. In this way, it is possible to impress the torque-forming current in the machine more quickly and the speed control circuit has a lower tendency toward vibration.

The cross-coupling exists between the flux-forming current I_{sd} and the torque-forming current I_{sq} and is caused by the voltage drop at the stator inductivity and the stator leakage inductivity. For this reason, the cross-coupling increases with the stator frequency. The cross-coupling becomes particularly apparent in the case of high stator frequencies at relatively small switching frequencies (e.g. 300 Hz stator frequency at 4 kHz switching frequency), as with small switching frequencies, the current controller slows down.

Parameters		Setting		
No.	Description	Min.	Max.	Fact. sett.
746	Cross-Coupling Factor	0.00%	300.00%	100.00% ¹⁾
				75.00% ²⁾

¹⁾*Configuration 30* = 410

²⁾*Configuration 30* = 610

Cross-coupling compensation can be optimized as follows:

- First, set the speed controller. To that end, define reference speed jumps at small rotary frequencies. See chapter 7.9.5.3 "Speed controller".
- Set a speed of approx. $\frac{2}{3}$ of the rated speed.
- Define reference speed jumps again. During the accelerations, currents I_{sq} of approx. 50% of the rated current should occur.
- Starting from 0%, increase the value of *Cross-Coupling Factor* **746** in steps of 25%, for example.
- The influence by I_{sq} on I_{sd} during the reference speed jumps should decrease with increasing values of *Cross-Coupling Factor* **746**. For checking, signal sources I_{sd} and I_{sq} can be oscilographed using the scope function of the PC user software. A minimum influence should be reached at 100%.
- Set the *Cross-Coupling Factor* **746** to a value slightly below the determined optimum value.

Very high values for *Cross-Coupling Factor* **746** (e.g. 125%) may result in an overcurrent circuit break.

7.9.5.2 Torque controller

The sensorless field oriented control for ASM (configuration 410) and the sensorless field oriented control for PSM (configuration 610) can be used for sensorless torque control alternative to the speed control. The torque control is usable above the *Frequency Limit* **624**. Below the *Frequency Limit* **624** the current impression is active with the current reference frequency as reference value. In this case the torque is not controlled, but results depending on the load and the *Starting current* **623**. To achieve a starting in torque control, the reference frequency should be set higher than *Frequency Limit* **624**. This is guaranteed in example by setting *Minimum frequency* **418** > *Frequency Limit* **624**.

$f < \text{Frequency Limit } 624$: Current impression

$f \geq \text{Frequency Limit } 624$: Direct Torque Control

The *Frequency Limit* **624** is set automatically during the motor setup.

The energy saving function shouldn't be used when using the Torque controller, since it influences the control dynamics significantly.

An overview of important parameters for using the Torque Controller is compiled in chapter 6.7.8 "Torque control".

7.9.5.2.1 Torque reference

The reference torque can be specified as follows:

- Set parameter *n-/T-Control Change-Over* **164** to "6 - On" or link it to a digital signal and switch this on.
- Via parameter *Reference Percentage Source 1* **476** or *Reference Percentage Source 2* **494**, select a source for the reference torque.

For example:

- The reference torque can be set via the arrow keys of the operator panel if the following setting is selected: *Reference Percentage Source 2* **494** = "5 - keypad motorpoti (factory setting)".
- The reference torque can be set via multifunction input 1 (MFI1A) if the following setting is selected: *Reference Percentage Source 1* **476** = "1 - analog value MFI1A (factory setting)".
- 100 % Torque refer to the calculated Torque from *Rated Mech. Power* **376** (Motor power) and *Rated Speed* **372** (Motor nominal speed).

Parameter *Torque* **224** shows the actual torque.

Select an applicable operation mode for parameter *Operation Mode Flying Start* **645**. Refer to chapter 7.3.5 "Flying Start".

7.9.5.2.2 Upper limit and lower limit of the frequency in Torque Control

767 Frequency Upper Limit

768 Frequency Lower Limit

In many cases limitation of the speed is required in the operating points with reduced or without load torque, because the speed regulates itself to the torque reference and the load behaviour. To avoid an unintentional speed (mostly too high speeds, in some cases also too small speeds and avoidance of current impression), the frequency is limited by *Frequency Upper Limit 767* and *Frequency Lower Limit 768* by the speed controller.

As from the limit value the drive is controlled to maximum speed (*Frequency Upper Limit 767* and *Frequency Lower Limit 768*), which corresponds to the behaviour of the speed controller. Additionally, the controller limits the speed to *Maximum Frequency 419*. This limitation is set by the speed controller – changes in the speed controller affect the speed behaviour in the limit area of the 3 mentioned parameters.

In the current impression, the speed is limited additional to *Minimum Frequency 418* – in Direct Torque Control this limit is not active.

Parameters		Setting		
No.	Description	Min.	Max.	Fact. sett.
767	Frequency Upper Limit	-599.00 Hz	599.00 Hz	599.00 Hz
768	Frequency Lower Limit	-599.00 Hz	599.00 Hz	-599.00 Hz

Note: Positive values limit the speed in clockwise direction; negative values limit the speed in anti-clockwise direction. In example, if both values are positive (> 0 Hz), anticlockwise movement is inhibited.



WARNING

If the torque control is activated while the actual frequency lies outside the defined range of *Frequency Upper Limit 767* and *Frequency Lower Limit 768* (in example when switching on a stopped machine or when the Flying start synchronizes), the allowed frequency is driven to without ramps. The torque is only limited by the limitations of the speed controller (current and torque). Therefore an unexpected dynamic behaviour can occur.

7.9.5.2.3 Limit Value Sources

769 Frequency upper limit source

770 Frequency lower limit source

The frequency can be limited by setting fixed values or linking an analog input.

The assignment is done for the torque controller via *Frequency Upper Limit source 769* and *Frequency Upper Limit source 770*. The frequency limits of the analog value relate to 0 Hz and *Maximum Frequency 419*. Setting a torque limit is done for *Minimum Reference Percentage 518* and *Maximum Reference Percentage 519*.

Operation mode 769, 770	Function
1 - Analog input MFI1A	The source is the multifunctional input 1 in analog operation mode (parameter <i>Operation Mode MF11 452</i>). The scaling refers to 100 % = <i>Maximum frequency 419</i> for the upper limit and 0 % = 0 Hz for the lower limit.
2 - Analog input MFI2A	The source is the multifunctional input 2 in analog operation mode (parameter <i>Operation Mode MF12 562</i>). The scaling refers to 100 % = <i>Maximum frequency 419</i> for the upper limit and 0 % = 0 Hz for the lower limit.
10 - Fixed limit	The selected parameter values are taken into account to limit the speed controller. Factory setting.
708 - RxPDO1 Long1	Process data of system bus. Refer to instructions on system bus. The value is processed as frequency.
709 - RxPDO1 Long2	Process data of system bus. Refer to instructions on system bus. The value is processed as frequency.
2501 - PLC Output Frequency 1	Output value of a PLC function. Refer to application manual PLC.
2502 - PLC Output Frequency 2	Output value of a PLC function. Refer to application manual PLC.
10001 ... 12502	Inverted values of signal sources 1 to 2502.

7.9.5.2.4 Switching over between speed control and torque control

Via the signal assigned to parameter *n-/T-Control Change-Over 164*, you can switch between speed control and torque control. See chapter 7.6.6.10 "n-/T-control changeover".

7.9.5.3 Speed controller

720 Operation mode (speed controller)

The control of the torque-forming current components is done in the outer control loop by the speed controller. Via parameter *Operation Mode 720*, you can select the operation mode for the speed controller. The operation mode defines the use of the parameterizable limits. These are referred to the direction of rotation and the direction of the torque and depend on the selected configuration.

Operation Mode 720	Function
0 - Speed controller off	The controller is deactivated or the torque-forming component is zero.
1 - Limits for motor/generator op.	The limitation of the speed controller assigns the upper limit to the motor operation of the drive. Independent of the direction of rotation, the same limit is used. The same applies in the case of regenerative operation with the lower limit. Factory setting.
2 - Limits pos./neg. torque	The assignment of the limit is done by the sign of the value to be limited. Independent of the motor or generator operating points of the drive, the positive limitation is done by the upper limit. The lower limit is regarded as a negative limitation.

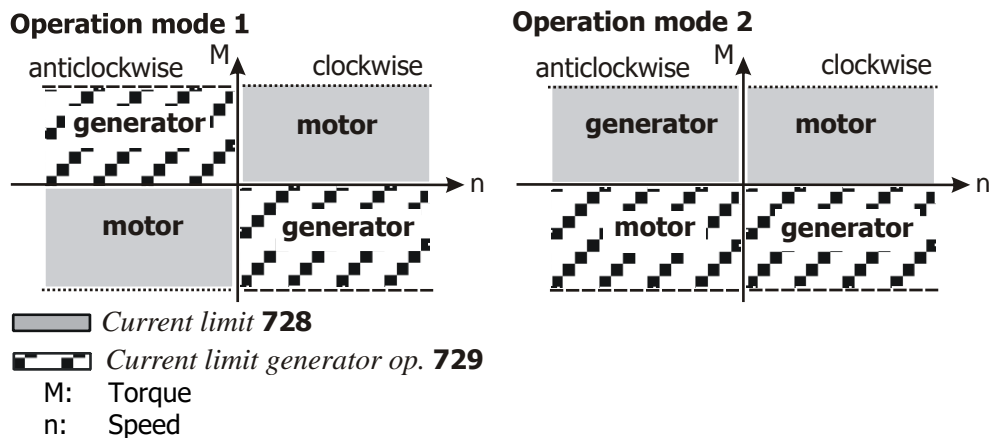

721 Amplification 1 ($|f| < P738$)

722 Integral Time 1 ($|f| < P738$)

723 Amplification 2 ($|f| > P738$)

724 Integral Time 2 ($|f| > P738$)

738 Speed Control Switch-Over Limit

748 Backlash Damping

The properties of the speed controller can be adapted for adjustment and optimization of the controller.

The amplification and integral time of the speed controller can be set via parameters *Amplification 1* ($|f| < P738$) **721** and *Integral Time 1* ($|f| < P738$) **722**. For the second speed range, parameters *Amplification 2* ($|f| > P738$) **723**, *Integral Time 2* ($|f| > P738$) **724** can be set. The distinction between the speed ranges is done by the value set with parameter *Speed Control Switch-Over Limit* **738**. Parameters *Amplification 1* ($|f| < P738$) **721** and *Integral Time 1* ($|f| < P738$) **722** are considered with the default parameter *Speed Control Switch-Over Limit* **738**. If parameter *Speed Control Switch-Over Limit* **738** is set to a value greater than 0.00 Hz, parameters *Amplification 1* ($|f| < P738$) **721**, *Integral Time 1* ($|f| < P738$) **722** will be active below this limit, and parameters *Amplification 2* ($|f| > P738$) **723**, *Integral Time 2* ($|f| > P738$) **724** will be active above this limit.

The parameterized amplification at the current operating point can additionally be assessed via the parameter *Backlash Damping* **748** depending on the control deviation. In particular the small signal behaviour in applications with a gearbox can be improved by a value higher than zero percent.

Parameters		Setting		
No.	Description	Min.	Max.	Fact. sett.
721	Amplification 1 ($ f < P738$)	0.00	200.00	- 1)
722	Integral Time 1 ($ f < P738$)	0 ms	60000 ms	
723	Amplification 2 ($ f > P738$)	0.00	200.00	
724	Integral Time 2 ($ f > P738$)	0 ms	60000 ms	
738	Speed Control Switch-Over Limit	0.00 Hz	599.00 Hz	55.00 Hz
748	Backlash Damping	0%	300%	100%

The optimization of the speed controller can be done with the help of a reference value leap. The amount of the leap is defined by the set ramp or limitation. The optimization of the PI controller should be done at the maximum admissible reference figure change rate. First, the amplification is increased until the actual value overshoots distinctly during the control process. This is indicated by a strong oscillation of the speed and by the running noises. In the next step, reduce the amplification slightly (1/2 ... 3/4 etc.). Then reduce the integral time (larger I component) until the actual value overshoots only slightly in the control process.

If necessary, check the speed control settings in the case of dynamic operations (acceleration, deceleration). The frequency at which the switch-over of the controller parameters is effected can be set via parameter *Speed Control Switch-Over Limit* **738**.

7.9.5.3.1 Limitation of speed controller

The output signal of the speed controller is the torque-forming current component I_{sq} . The output and the I portion of the speed controller can be limited via parameters *Current Limit* **728**, *Current Limit Generator Op.* **729**, *Torque Limit* **730**, *Torque Limit Generator Operation* **731** or *Power Limit* **739**, *Power Limit Generator Operation* **740**. The limits of the proportional portion are set via parameters *P-Comp. Torque Upper Limit* **732** and *P-Comp. Torque Lower Limit* **733**.

¹ The default settings for amplification and integral time refer to the recommended machine data. This enables a first function test in a large number of applications. Switch-over between settings 1 and 2 for the current frequency range is done by the software according to the selected limit value.

728 Current Limit

729 Current Limit Generator Op.

The output value of the speed controller is limited by an upper and a lower current limit. From the set values for *Current limit 728* and *Current limit generator operation 729*, the limits are calculated, considering the set magnetizing current. The parameter values are entered in Amperes. The current limits of the controller can be linked to the fixed limits and analog input parameters. The assignment is done via the parameters *Isq Limit Source Motor Operation 734* and *Isq Limit Source Generator Op. 735*.

Parameters		Setting		
No.	Description	Min.	Max.	Fact. sett.
728	Current Limit	0.0 A	$o_c \cdot I_{FIN}$	$o_c \cdot I_{FIN}$
729	Current Limit Generator Op.	-0.01 A ¹⁾	$o_c \cdot I_{FIN}$	-0.01 A

I_{FIN} : Nominal value of frequency inverter

o_c : Overload capacity of frequency inverter

¹⁾ If the minimum value is set, the value of *Current Limit 728* is used.

730 Torque Limit

731 Torque Limit Generator Operation

The output value of the speed controller is limited by an upper and a lower torque limit, parameter *Torque Limit 730* and parameter *Torque Limit Generator Operation 731*. The limit values are input as a percentage of the rated motor torque. The assignment of fixed values or analog limit values is done via the parameters *Torque Limit Source Motor Op. 736* and *Torque Limit Source Gen. Op. 737*.

Parameters		Setting		
No.	Description	Min.	Max.	Fact. sett.
730	Torque Limit	0.00%	650.00%	650.00%
731	Torque Limit Generator Operation	0.00%	650.00%	650.00%

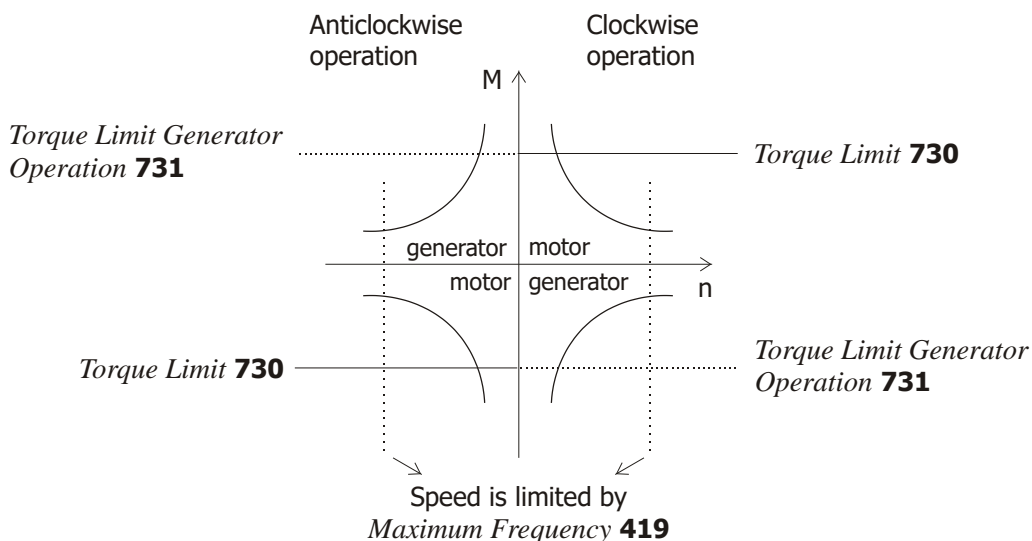

732 P-Comp. Torque Upper Limit

733 P-Comp. Torque Lower Limit

The output value of the P component of the torque controller is limited by parameter *P-Comp. Torque Upper Limit 732* and *P-Comp. Torque Lower Limit 733*. The limit values are input as torque limits as a percentage of the rated motor torque.

Parameters		Setting		
No.	Description	Min.	Max.	Fact. sett.
732	P-Comp. Torque Upper Limit	0.00%	650.00%	650.00%
733	P-Comp. Torque Lower Limit	0.00%	650.00%	650.00%

739 Power Limit

740 Power Limit Generator Operation

The power output by the motor is proportional to the product of speed and torque. This output power can be limited at the speed controller output with *Power Limit 739* and *Power Limit Generator Operation 740*. The power limits are entered in kW.

Parameters		Setting		
No.	Description	Min.	Max.	Fact. sett.
739	Power Limit	0.00 kW	2 · o _c · P _{FIN}	2 · o _c · P _{FIN}
740	Power Limit Generator Operation	0.00 kW	2 · o _c · P _{FIN}	2 · o _c · P _{FIN}

P_{FIN} = Nominal Frequency inverter power
o_c: Overload capacity of frequency inverter

7.9.5.3.2 Limit value sources

734 Isq Limit Source Motor Operation

735 Isq Limit Source Generator Op.

736 Torque Limit Source Motor Op.

737 Torque Limit Source Gen. Op.

As an alternative to limiting the output values by a fixed value, linking to an analog input value is also possible. The analog value is limited via parameters *Minimum Reference Percentage 518*, *Maximum Reference Percentage 519*, but does not consider the *Gradient Percentage Ramp 477* of the reference percentage value channel.

The assignment is done with the help of the parameters *Isq Limit Source Motor Operation 734* and *Isq Limit Source Generator Op. 735* for the torque-forming current component Isq.

The sources for the torque limits can be selected via the parameters *Torque Limit Source Motor Op. 736* and *Torque Limit Source Gen. Op. 737*.

Operation mode 734, 735, 736, 737	Function
101 - Analog Input MFI1A	Multifunction input 1 is the source. Via parameter <i>Operation Mode MFI1 452</i> , multifunction input 1 must be set up as a voltage or current input.
102 - Analog Input MFI2A	Multifunction input 2 is the source. Via parameter <i>Operation Mode MFI2 562</i> , multifunction input 2 must be set up as a voltage or current input.
105 - Repetition Percentage Input	The percentage signal at the repetition frequency input (IN2D, terminal X11.5). <i>Operation Mode IN2D 496</i> must be set to 20 or 21. See chapter 7.6.7 "Input PWM/repetition frequency/pulse train".
110 - Fixed Limit	The selected parameter figures for limiting the speed controller are taken into account. Factory setting.
714 - RxPDO2 Word 1	Process data of the system bus. Refer to instructions on system bus.
715 - RxPDO2 Word 2	Process data of the system bus. Refer to instructions on system bus.
2521 - PLC Output Percentage 1	Output value of a PLC-function. Refer to application manual "PLC".

Operation mode 734, 735, 736, 737	Function
2522 - PLC Output Percentage 2	Output value of a PLC-function. Refer to application manual "PLC".



The limit values and assignment to different limit value sources are data set related in the configurations. The use of the data record changeover demands an examination of the parameters in question.

7.9.5.3 Switching over between speed control and torque control

Via the signal assigned to parameter *n-/T-Control Change-Over* **164**, you can switch between speed control and torque control. See chapter 7.6.6.10 "n-/T-control changeover".

7.9.5.4 Acceleration pre-control

725 Operation Mode

The acceleration pre-control controlled parallel to the speed controller reduces the reaction time of the drive system to a change of reference values.

The acceleration pre-control is active in the speed-controlled configurations and can be activated via parameter *Operation Mode* **725**.

Operation Mode 725	Function
0 - Off	The control system is not influenced. Factory setting.
1 - Switched on	The acceleration pre-control is active according to the limit values.

726 Minimum Acceleration

727 Mech. Time Constant

The minimum acceleration time defines the modification speed of the reference speed value as from which a torque necessary for acceleration of the drive is pre-controlled. The acceleration of the mass is a function of the *Mech. Time Constant* **727** of the system. The value calculated from the increase of the reference value and the multiplication factor of the torque required is added to the output signal of the speed controller.

Parameters		Setting		
No.	Description	Min.	Max.	Fact. sett.
726	Minimum Acceleration	0.1 Hz/s	6500.0 Hz/s	1.0 Hz/s
727	Mech. Time Constant	1 ms	60000 ms	10 ms

For optimal setting, the acceleration pre-control is switched on and the mechanical time constant is set to the minimum value. The output value of the speed controller is compared to the minimum acceleration time during the acceleration processes. The frequency ramp is to be set to the highest value occurring in operation at which the output figure of the speed controller is not yet limited. Set the value of *Minimum Acceleration* **726** to half the set acceleration ramp. In this way, it is ensured that the acceleration pre-control becomes active.

During several acceleration attempts, increase the *Mech. Time Constant* **727** until the output value (signal source 37 – acceleration pre-control output) during the acceleration roughly corresponds to the torque-forming current I_{sq} (signal source 141). In the case of drives with a high friction or other high resistance torque, deduct the corresponding portion from the torque-forming current I_{sq} before. This setting should also minimize overshooting of the speed controller. Alternatively, you can calculate the mechanical time constant at a known mass moment of inertia. The mechanical time constant is the time the drive needs during acceleration from standstill with rated torque applied until the *Rated Speed* **372** is reached.

7.9.5.5 Field controller

717 Flux Reference Value

741 Amplification

742 Integral time

The flux-forming current component is controlled by the field controller. The guided commissioning optimizes the parameters of the field controller by measuring the time constant and magnetizing curve of the connected asynchronous motor. The parameters of the field controller are selected such that they can be used without changes in most applications. The proportional and the integrating part of the field controller are to be set via parameters *Amplification* **741** und *Integral Time* **742**.

Parameters		Setting		
No.	Description	Min.	Max.	Fact. sett.
717	Flux Reference Value	0.01%	300.00%	100.00%
741	Amplification	0.0	100.0	5.0
742	Integral Time	0.0 ms	1000.0 ms	100.0 ms

Please note, that changes within the Field controller parameters should only be done in the basic speed area.

When an optimization of the Field controller is necessary, set the *Integral Time* **742** = *Act. Rotor Time Constant* **227** / 2, meaning to the half of the rotor time constant. In most application cases, this change is sufficient.

When further optimizations are necessary, follow the step described in the following procedure.

- Set the output frequency in a way (i.e. via the frequency reference value), that the actual value *Modulation* **223** = 80...90 % *Reference Modulation* **750**.
- Now change the *Flux Reference Value* **717** from 100 % to 90 %. Oscillograph the actuating variable I_{sd} . The course of the signal of the flux-forming current I_{sd} should reach the stationary value after overshooting without oscillation.
- Change the parameters *Amplification* **741** and *Integral Time* **742** according to the application requirements.
- Change the *Flux Reference Value* **717** back to 100 % und repeat the flux reference step while you can analyze the changes with the oscillograph. Repeat these steps if necessary.

If a quick transition into field weakening is necessary for the application, the integral time should be reduced. Increase the *Amplification* **741** in order to achieve a good dynamism of the controller.

An increased overshoot is necessary for a good control behaviour in controlling of a load with low-pass behaviour, e.g. an asynchronous motor.

7.9.5.5.1 Limitation of field controller

743 Ref. Isd Upper Limit

744 Ref. Isd Lower Limit

The output signal of the field controller, the integrating and proportional components are limited via parameters *Ref. Isd Upper Limit* **743** and *Ref. Isd Lower Limit* **744**. The guided commissioning (setup) in *Configuration* **30** = 410 set parameter *Ref. Isd Upper Limit* **743** according to parameter *Rated Current* **371**.

In setting *Configuration* **30** = "610 -PMSM: sensor-less field-orientated control (DMC)" (synchronous motor), parameters *Ref. Isd Upper Limit* **743** and *Ref. Isd Lower Limit* **744** are set to 10% of the value of *Rated Current* **371** during guided commissioning (setup).

Parameters		Setting		
No.	Description	Min.	Max.	Fact. sett.
743	Ref. Isd Upper Limit	0.0	$o_c \cdot I_{FIN}$	I_{FIN}
744	Ref. Isd Lower Limit	$- I_{FIN}$	I_{FIN}	0.0

I_{FIN} : Nominal value of frequency inverter

o_c : Overload capacity of frequency inverter.

The limits of the field controller define not only the maximum current occurring, but also the dynamic properties of the controller. The upper and lower limits restrict the modification speed of the motor flux and the torque resulting from it. In particular the speed area above the nominal frequency should be observed for the modification of the flux-forming component. The upper limit is to be estimated from the product of the set magnetizing current and the correction factor *Flux Reference Value 717*, although the limit must not exceed the overload current of the drive.

7.9.5.6 Modulation controller

750 Reference Modulation

752 Integral Time

753 Operation Mode (modulation controller)

The modulation controller, which is designed as an I regulator, automatically adapts the output value of the frequency inverter to the machine behaviour in the basic speed area and in the field weakening area. If the modulation exceeds the figure set with parameter *Reference Modulation 750*, the field-forming current component and thus the flux in the machine are reduced.

In order to make the best possible use of the voltage available, the figure selected via parameter *Operation Mode 753* is put into proportion to the DC link voltage. That means that with a high mains voltage there is also a high output voltage available, the drive only reaches the field weakening area later and produces a higher torque.

<i>Operation Mode 753</i>	Function
0 - U_{sq} control	The modulation is calculated from the ratio of torque-forming voltage component U_{sq} to the DC link voltage.
1 - U abs. value control	The modulation is calculated from the abs. voltage value / DC link voltage ratio. Factory setting.

The integrating part of the modulation controller is to be set via parameter *Integral Time 752*.

Parameters		Setting		
No.	Description	Min.	Max.	Fact. sett.
750	Reference Modulator	3.00%	105.00%	102.00%
752	Integral Time	0.0 ms	1000.0 ms	10.0 ms

The percentage setting of the *Reference Modulation 750* is basically a function of the leakage inductivity of the machine. The default value was selected such that in most cases the remaining deviation of 5% is sufficient as a reserve range for the current controller. For the optimization of the controller parameters, the drive is accelerated with a flat ramp into the area of field weakening, so that the modulation controller intervenes. The limit is set via parameter *Reference Modulation 750*. Then, the control loop can be excited with a jump function by modifying the reference modulation (changeover between 95% and 50%). By means of an oscillographed measurement of the flux-forming current component on the analog output of the frequency inverter, the controlling process of the modulation controller can be assessed. The course of the signal of the flux-forming current I_{sd} should reach the stationary value after overshooting without oscillation. An oscillating of the course of the current can be damped by increasing the integral time.

7.9.5.6.1 Limitation of modulation controller

755 Reference Imr Lower Limit

756 Control Deviation Limitation

The output signal of the modulation controller is the internal reference flux. The controller output and the integrating part are limited via the parameter *Reference Imr Lower Limit 755* or the product of *Rated Magnetising Current 716* and *Flux Reference Value 717*. The magnetizing current parameter forming the upper limit is to be set to the rated value of the machine. For the lower limit, select a value which also builds up an adequate flux in the machine in the field weakening area. The limitation of the control deviation at the output of the modulation controller prevents a possible oscillation of the control loop in the case of load surges. The parameter *Control Deviation Limitation 756* is stated as an absolute value and acts both as a positive and a negative limit.

Parameters		Setting		
No.	Description	Min.	Max.	Fact. sett.
755	Reference Imr Lower Limit	$0.01 \cdot I_{FIN}$	$0_c \cdot I_{FIN}$	$0.01 \cdot I_{FIN}$
756	Control Deviation Limitation	0.00%	100.00%	10.00%

I_{FIN} : Nominal value of frequency inverter
 0_c : Overload capacity of frequency inverter.

7.9.6 Real-time tuning (optimizing motor parameters in operation)

1520 Operation mode real-time tuning

Motor parameters measured during commissioning (setup) at standstill will change during operation, e.g. as a result of changing motor winding temperatures. Real-time tuning compensates these changes. While the drive is running, the controller settings are adjusted continuously to changing motor properties and the control behaviour is optimized. Real-time tuning can be used in V/f characteristic control (*Configuration 30* = 110) and the field-orientated control methods (*Configuration 30* = 410 or 610).

Parameter *Operation mode real-time tuning 1520* enables the following settings:

- Activation of real-time tuning.
- Optimized control parameters are to be saved after shut-down of the frequency inverter.
- Optimized controller parameters are to be applied in a new data set after a data set changeover.

<i>Operation mode real-time tuning 1520</i>	Function
0 - Off	Real-time tuning is switched off. The controller settings and motor parameters are not changed during operation. Factory setting.
1 - On	Real-time tuning is switched on. After shut-down or restart of the frequency inverter or after a data set changeover, the changed controller parameters are deleted again and replaced by the static values. The static values contain the motor data measured during commissioning (setup).
3 - Latching	Real-time tuning is switched on. Optimized control parameters are saved after shut-down of the frequency inverter (non-volatile). Each data set is saved separately. In this way, real-time tuning may also be used for operating cases with motor changeover.
5 - Taking Over	Real-time tuning is switched on. Optimized control parameters are not saved after shut-down or restart of the frequency inverter. Optimized controller settings are applied in a new data set after a data set changeover.
7 - Latching and Taking Over	Combination of "Latching" and "Taking Over". Real-time tuning is switched on. Optimized control parameters are saved after shut-down or restart of the frequency inverter (non-volatile). Optimized controller settings are applied in a new data set after a data set changeover.

7.10 Special functions

The configurable functions of the corresponding control methods enable another field of application of the frequency inverters. The integration in the application is made easier by special functions.

7.10.1 Pulse width modulation

400 Switching Frequency

The motor noises can be reduced by changing over the parameter *Switching Frequency 400*. A reduction of the switching frequency should be up to a maximum ration of 1:10 to the frequency of the output signal for a sine-shaped output signal. The maximum possible switching frequency depends on the drive output and the ambient conditions. For the required technical data refer to the corresponding table and the device type diagrams.

Parameters		Configuration 30	Setting		
No.	Description	Selection	Min.	Max.	Fact. sett.
400	Switching Frequency	110	2 kHz	16 kHz	2 kHz
		410, 610	4 kHz		4 kHz

The factory setting of parameter *Switching Frequency* **400** depends on the setting of parameter *Configuration* **30**.

401 Min. Switching Frequency

The heat losses increase proportionally to the load point of the frequency inverter and the switching frequency. The automatic reduction adjusts the switching frequency to the current operating state of the frequency inverter in order to provide the output performance required for the drive task at the greatest possible dynamics and a low noise level.

The switching frequency is adapted between the limits which can be set with the parameters *Switching Frequency* **400** and *Min. Switching Frequency* **401**. If the *Min. Switching Frequency* **401** is larger than or equal to the *Switching Frequency* **400**, the automatic reduction is deactivated.

Parameters		Setting		
No.	Description	Min.	Max.	Fact. sett.
401	Min. Switching Frequency	2 kHz	16 kHz	2 kHz

580 Reduction Limit Ti/Tc

The change of the switching frequency depends on the heat sink temperature switch-off limit and the output current. The temperature limit to be exceeded so that the switching frequency is reduced can be set via parameter *Reduction Limit Ti/Tc* **580**. If the heat sink temperature falls below the threshold set via parameter *Reduction Limit Ti/Tc* **580** by 5 °C, the switching frequency is increased again step by step.

Parameters		Setting		
No.	Description	Min.	Max.	Fact. sett.
580	Reduction Limit Ti/Tc	-25 °C	0 °C	-4 °C



The limit for the switching frequency reduction is influenced by the intelligent current limits depending on the selected *Operation Mode* **573** and the output current. If they have been switched off or provide the full overload current, the switching frequency is reduced when the output current exceeds the limit of 87.5% of the long-term overload current (60 s). The switching frequency is increased if the output current drops below the reference current of the next highest switching frequency.

7.10.2 Fan

39 Switch-On Temperature

The fans run in two power stages.

The fans are switched on with the following conditions:

- If the inside, capacitor or heat sink temperature exceeds the value of *Switch-On Temperature* **39**, the inside fan and the heat sink fan will be switched on and run at half power.
A possible external fan is also switched on via the parameterized digital output.
- Independent of the setting of *Switch-On Temperature* **39** the fans start at half power when internal fixed temperature thresholds (internal temperature, Capacitor temperature) have been reached.
- If the measured temperatures increase also at half power of the fans, the fans will be switched to full power when a critical temperature threshold is reached.



To protect the device a device fault is triggered when reaching an internal switching off temperature threshold.

The fans will be switched off again as soon as the heat sink temperature has dropped below the *Switch-On Temperature 39* by 5 °C and the internal temperatures dropped 5°C below their first switch-on thresholds.

Parameters		Setting		
No.	Description	Min.	Max.	Fact. sett.
39	Switch-On Temperature	0 °C	60 °C	30 °C

Further fan control setting options

Operation mode "43 - external fan" for digital outputs additionally enables the control of an external fan. Via the digital output, the external fan is switched on as soon as the *Switch-On Temperature 39* for the internal fans was reached. See chapter 7.6.5 "Digital outputs".

Via parameter *Standby Mode 1511*, you can set that the internal fans are switched off if enable is switched off. See chapter 8.3 "Standby mode".

7.10.3 Standby mode and energy saving function

Refer to chapter 8 "Energy saving".

7.10.4 Brake chopper and brake resistor

506 Trigger Threshold

The frequency inverters feature a brake chopper transistor. The external brake resistor is connected to terminals Rb1 and Rb2. The parameter *Trigger Threshold 506* defines the switch-on threshold of the brake chopper. The generator output of the drive, which leads to the increase in the DC link voltage, is converted to heat by the external brake resistor above the limit set via parameter *Trigger Threshold 506*.

Parameters		Setting			
No.	Description	Min.	Max.	Fact. sett.	
506	Trigger Threshold	KFU A2	225.0 V	1000.0 V	390.0 V
		KFU A4	325.0 V	1000.0 V	780.0 V

Set parameter *Trigger Threshold 506* such that it is between the maximum DC link voltage which the mains can generate and the maximum admissible DC link voltage of the frequency inverter.

$$U_{\text{Mains}} \cdot 1.1 \cdot \sqrt{2} < U_{\text{dBC}} < U_{\text{dmax}}$$

If the parameter *Trigger Threshold 506* is set larger than the maximum admissible DC link voltage, the brake chopper cannot become active; the brake chopper is switched off.

If the parameter *Trigger Threshold 506* is set to a value below the DC link voltage generated by the mains, error message F0705 (chapter 13.1.1 "Error messages")s displayed if the start command is issued to the frequency inverter.

If the DC link voltage exceeds the maximum value of DC 800 V, error message F0700 (see chapter 13.1.1 "Error messages").

The sampling time of the function is 62.5 μs. The brake chopper remains on for at least 62.5 μs after the set trigger threshold was exceeded even if the value drops below the trigger threshold within this period again.

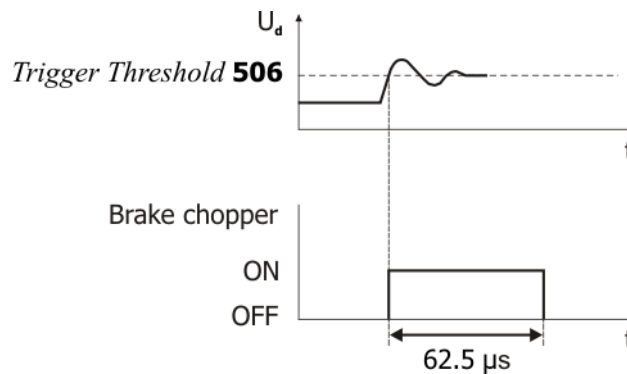

Release or disable brake chopper

Via the signal assigned to parameter *Brake Chopper Release* **95**, the brake chopper can be released or disabled. See chapter 7.6.6.13 "Brake chopper release".



Please note that by default the Motor chopper *Trigger Threshold* **507** and the *Trigger Threshold* **506** are set up with different values. Check, that the two thresholds are set up fittingly for your application.

Please check chapter 7.10.5 "Motor chopper".

7.10.4.1 Dimensioning of brake resistor



WARNING

Connect a brake resistor following the instructions and safety information provided in chapter 5.6.5 "Brake resistor".

The following values must be known for dimensioning:

- Peak braking power $P_{b\ Peak}$ in W
- Resistance R_b in Ω
- Relative operation time OT in %
- Calculation of peak braking power $P_{b\ Peak}$

$$P_{b\ Peak} = \frac{J \cdot (n_1^2 - n_2^2)}{182 \cdot t_b}$$

$P_{b\ Peak}$	=	Peak braking power in W
J	=	Moment of inertia of drive system in kgm^2
n_1	=	Speed of drive system before the braking operation in min^{-1}
n_2	=	Speed of drive system after the braking operation in min^{-1}
t_b	=	Braking time in s

- Calculation of resistance R_b

$$R_b = \frac{U_{dBC}^2}{P_{b\ Peak}}$$

R_b	=	Resistance in Ω
U_{dBC}	=	Switch-on threshold in V
$P_{b\ Peak}$	=	Peak braking power in W

The switch-on threshold U_{dBC} is the DC link voltage at which the brake resistor is switched on. The switch-on threshold can be set via parameter *Trigger Threshold* **506**.

CAUTION

The resistance of the brake resistor must not be less than the minimum value $R_{b \min}$ -10%. The values for $R_{b \min}$ are listed in chapter 11 "Technical data".



If the calculated resistance R_b of the brake resistor is between two standard series values, the lower resistance must be selected.

- Calculation of relative operation time OT

$$OT = \frac{t_b}{t_c}$$

OT = Relative operation time (percentage duty cycle)
 t_b = Braking time (duty cycle)
 t_c = Cycle time

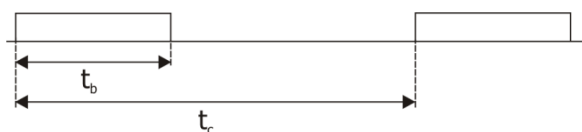

Example:
 $t_b = 48 \text{ s}, t_c = 120 \text{ s}$
 $OT = \frac{t_b}{t_c} = 0.4 = 40\%$

In the case of infrequent short braking operations, typical values of the relative operation time OT are at 10%, for long braking operations ($\geq 120 \text{ s}$) typical values are at 100%. In the case of frequent deceleration and acceleration operations, it is recommended that the relative operating time OT be calculated according to the above formula.

The calculated values for $P_{b \text{ Peal}}$, R_b and OT can be used by the resistor manufacturers for determining the resistor-specific permanent power.

7.10.5 Motor chopper

507 Trigger Threshold

The field-orientated control systems for asynchronous motors (configuration 410 FOC) contain the function for adapted implementation of the generator energy into heat in the connected three-phase machine. This enables the realization of dynamic speed changes at minimum system costs. The torque and speed behaviour of the drive system is not influenced by the parameterized braking behaviour. The parameter *Trigger Threshold 507* of the DC link voltage defines the switch-on threshold of the motor chopper function.

Parameters		Setting			
No.	Description	Min.	Max.	Fact. sett.	
507	Trigger Threshold	KFU A2	225.0 V	1000.0 V	400.0 V
		KFU A4	325.0 V	1000.0 V	800.0 V

Set parameter *Trigger Threshold 507* such that it is between the maximum DC link voltage which the mains can generate and the maximum admissible DC link voltage of the frequency inverter.

$$U_{\text{Mains}} \cdot 1.1 \cdot \sqrt{2} < U_{\text{dMC}} < U_{\text{dmax}}$$

If the parameter *Trigger Threshold 507* is set larger than the maximum admissible DC link voltage, the motor chopper cannot become active, the motor chopper is switched off.

If the set *Trigger Threshold 507* is smaller than the maximum DC link voltage the mains can generate, error message F0706 (chapter 13.1.1 "Error messages") is displayed when the frequency inverter is switched on.



The motor chopper function only works if activated via voltage Controller *Operation Mode 670*. See chapter 7.9.2 "Voltage controller".



For synchronous motors (*Configuration 30* = 610), the motor chopper function is deactivated to prevent damages to the motor. The other functions of the voltage controller are not affected by this.



Please note that by default the Motor chopper *Trigger Threshold 507* and the *Trigger Threshold 506* are set up with different values. Check, that the two thresholds are set up fittingly for your application.

Please check chapter 7.10.4 "Brake chopper and brake resist".

7.10.6 Motor Protection

The protection of the motor against impermissible temperature rise requires monitoring mechanisms for recognizing a thermal overload to prevent a possible damage to the motor. The thermal state of a motor can be evaluated by different ways.

1.) Direct monitoring by temperature sensors inside the motor winding (Please check chapter 7.4.6 "Motor temperature")

- PTC
- KTY
- PT100
- Thermal contact

2.) Indirect monitoring of the motor temperature

- Monitoring of the motor current based on the K characteristic of an integrated motor circuit breaker
- Emulation of the motor heating by using a temperature-relevant mathematical model I^2t

The choice of thermal control is mainly determined by type and operating conditions of the motor. For safe motor protection it is generally sufficient using one of the available possibilities. A combination of the two groups and their simultaneous operation is possible.

7.10.6.1 Motor protection by Motor Circuit Breaker

571 Operation Mode (motor circuit breaker)

Motor circuit breakers are used for protecting a motor and its supply cable against over-heating by overload. Depending on the overload level, they disconnect the motor from power supply immediately in the case of a short-circuit or they disconnect the motor if an overload has occurred for some time.

Conventional motor circuit breakers are commercially available for various applications with different trigger characteristics (L, G/U, R and K), as shown in the diagram below. As frequency inverters in most cases are used for supplying motors which are classified as operating equipment with very high starting currents, only the K-characteristic was realized in this function.

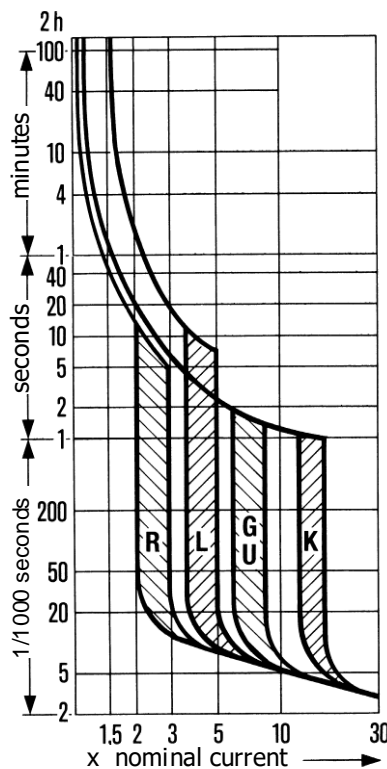

Unlike the operation of a conventional motor circuit breaker which disconnects the equipment to be protected immediately if the trigger threshold is reached, this function provides the possibility of issuing a warning instead of disconnecting the equipment immediately.

The rated current of the motor circuit breaker refers to the rated motor current stated via parameter *Rated Current* **371** of the corresponding data set. The rated values of the frequency inverter are to be considered accordingly when it comes to dimensioning the application.

The function of the motor circuit breaker can be linked to different data sets. In this way, it is possible to operate different motors via one frequency inverter. Thus, each motor can be equipped with its own motor circuit breaker.

In case a motor is operated via the frequency inverter for which some setting values, e.g. minimum and maximum frequency, are changed via the data set switch-over, only one motor circuit breaker may be installed. This functionality can be set for single or multi-motor operation via parameter *Operation Mode* **571**.

<i>Operation Mode 571</i>	<i>Function</i>
0 - Off	The function is deactivated. Factory setting.
1 - K-Char.,Mul.Motor Op.,Err.Sw.Off	In each of the four data sets, the rated values are monitored. Overloading the drive is prevented by the fault switch-off "F0401".
2 - K-Char.,Sing.Motor,Err.Sw.-Off	The rated values in the first data set are used independently of the active data set. Overloading the drive is prevented by the fault switch-off "F0401".
11 - K-Char.,Multi-Motor Op.,Warning	In each of the four data sets, the rated values are monitored. Overloading the drive mechanism is signaled by a warning message "A0200".
22 - K-Char.,Single-Motor,Warning	The rated values in the first data set are used independently of the active data set. Overloading the drive mechanism is signaled by a warning message "A0200".
42 - I ² t, Single-Motor, Error Switch Off	Please check chapter 7.10.6.2 "Motor Protection by I ² t- monitoring".
51 - I ² t, Multi-Motor Operation, Warning	
53 - I ² t, Single-Motor, Warning	
61 - I ² t, Multi-Motor Operation, Warning and Error Switch Off	
62 - I ² t, Single-Motor, Warning and Error Switch Off	
101- K-Char.,Multi-Motor Op.,Warning, stored	In each of the four data sets, the rated values are monitored. Overloading the drive is prevented by the fault switch-off "F0401". The internal state of the Motor circuit breaker is stored reset stable. These settings are to be used for short-time mains shut downs.
102- Char.,Sing.Motor,Err.Sw.-Off, stored	The rated values in the first data set are used independently of the active data set. Overloading the drive is prevented by the fault switch-off "F0401". The internal state of the Motor circuit breaker is stored reset stable. These settings are to be used for short-time mains shut downs.
111- K-Char.,Multi-Motor Op.,Warning, stored	In each of the four data sets, the rated values are monitored. Overloading the drive mechanism is signaled by a warning message "A0200".The internal state of the Motor circuit breaker is stored reset stable. These settings are to be used for short-time mains shut downs.
122 - K-Char.,Single-Motor,Warning, stored	The rated values in the first data set are used independently of the active data set. Overloading the drive mechanism is signaled by a warning message "A0200". The internal state of the Motor circuit breaker is stored reset stable. These settings are to be used for short-time mains shut downs

K-Char: K-characteristic of the motor circuit breaker

Multiple motor operation

Parameter *Operation Mode* **571** = 1 or 11, (101 or 111).

In multiple motor operation, it is assumed that each data set is assigned to a corresponding motor. For this, one motor and one motor circuit breaker are assigned to each data set. In this operation mode, the rated values of the active data set are monitored. The current output current of the frequency inverter is only taken into account in the motor circuit breaker activated by the data set. In the motor circuit breakers of the other data sets, zero current is expected, with the result that the thermal decay functions are taken into account. In combination with the data set changeover, the function of the motor circuit breakers is similar to that of motors connected alternately to the mains with their own circuit breakers.

Single motor operation

Parameter *Operation Mode* **571** = 2 or 22, (102 or 122).

The internal state of the motor circuit breaker is stored reset stable. These settings are to be used for short-time time mains shut downs. This way the motor protection is considered correctly also in applications where a short mains power off or a shutdown occurs.

Reset stable

Parameter *Operation Mode* **571** = **101, 102, 111** or **122**.

The internal state of the motor protection switch is latched reset stable. These be used when regularly short mains interruptions occur. This way the motor protection correctly for short mains failures or short shut downs of the application.



In settings 101, 102, 111 and 112 of *Operation Mode* **571** the same values should be set in all data sets.

572 Frequency Limit

The motor protection, especially of self-ventilated motors is improved by an adjustable frequency limit. Percentage reference is the rated frequency.

Parameters		Setting		
No.	Description	Min.	Max.	Fact. sett.
572	Frequency Limit	0%	300%	0%

In calculation the tripping time the measured output current in operating points below the frequency limit is evaluated by a factor between 1 and 2. The determination of this factor is a function of the stator frequency. The increased thermal load of self-ventilated motors in the lower speed range is therefore considered.

The table shows in extracts factors for motor rated frequency 50Hz.

← Frequency limit 572 →										
300% 200% 150% 100% 80% 60% 40% 20% 10%										
↓ Stator frequency [Hz]	0	200%	200%	200%	200%	200%	200%	200%	200%	200%
5	188%	182%	177%	168%	162%	153%	139%	114%	100%	100%
10	177%	168%	160%	147%	139%	129%	114%	100%	100%	100%
20	160%	147%	137%	122%	114%	106%	100%	100%	100%	100%
30	147%	132%	122%	109%	103%	100%	100%	100%	100%	100%
50	129%	114%	106%	100%	100%	100%	100%	100%	100%	100%
100	106%	100%	100%	100%	100%	100%	100%	100%	100%	100%
150	100%	100%	100%	100%	100%	100%	100%	100%	100%	100%

7.10.6.2 Motor Protection by I²t- monitoring

571 Operation Mode (I²t- monitoring)

To protect the motor against overload the I²t monitoring provides a further possibility for the user. This kind of motor protection is mainly used in servo technology. When using servo motors the I²t- monitoring is a proven alternative to motor protection switch. By integrating temperature-dependent parameters, measurable or known, the heating of a mathematical model is simulated. The kind of the I²t monitoring mode can be selected by *Operation Mode 571*. This parameter is switchable via data set.

The I²t monitoring works by function $(I_{act}/I_n)^2$ as shown in the figure. The monitored value is evaluated via a PT1 element with the thermal time constant of the stator. If the output of PT1 element is bigger than 120%, then an error message is generated and the drive switches off. The threshold of 120% prevents, that an overshoot leads to an immediate shutdown. In the application should be avoided exceeding 100% capacity of the stator winding permanently.

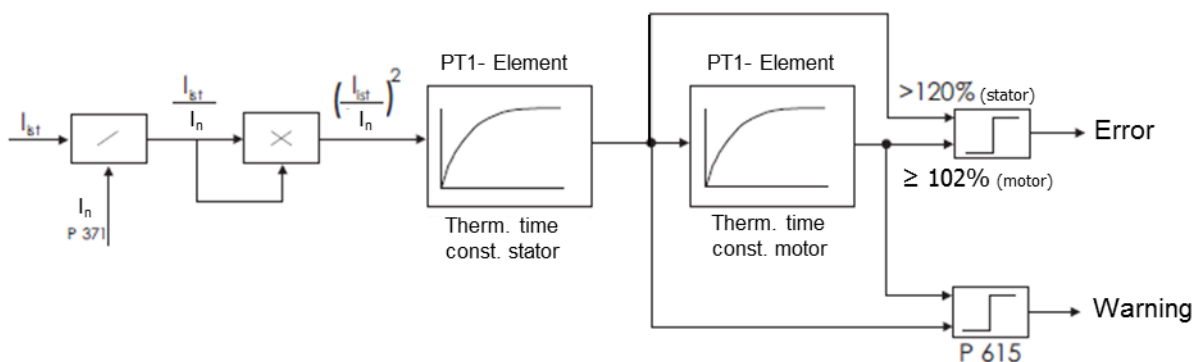

The output of the first PT1 element is linked to the input of the second PT1 element which includes the thermal motor time constant. This output may be permanently 100%. This corresponds to the complete thermal capacity of the motor. If 102% is reached, the drive switches off with an error message. Both outputs are connected to the adjustable alarm limit.

<i>Operation Mode 571</i>	Function
42 – I ² t, Single-Motor, Error Switch Off	The I ² t capacity of the motor is monitored with rated values from the active dataset. If the fixed threshold values exceed 100% _{motor} (120% _{stator}), the drive switches off with fault "F0401" in the active dataset.
51 – I ² t, Multi-Motor Operation, Warning	The I ² t capacity of the motors regarding their related ratings is monitored in each of the four data sets. If the <i>Warning Limit Motor I²t 615</i> is reached, the warning message "A0200" is signaled from the active data set.
52 – I ² t, Single-Motor, Warning	The I ² t capacity of the motor is monitored with rated values from the active dataset. If the <i>Warning Limit Motor I²t 615</i> is reached, the warning message "A0200" is signaled from the active data set.

Operation Mode 571	Function
61 – I ² t, Multi-Motor Operation, Warning and Error Switch Off	The I ² t capacity of the motors regarding their related ratings is monitored in each of the four data sets. If the <i>Warning Limit Motor I²t</i> 615 is reached, the warning message "A0200" is signaled from the active data set. If the fixed threshold values exceed 100% _{motor} (120% _{stator}), the drive switches off with fault "F0401" in the active dataset. Both incidences are triggered from the active dataset.
62 – I ² t, Single-Motor, Warning and Error Switch Off	The I ² t capacity of the motor is monitored with rated values from the active dataset. If the <i>Warning Limit Motor I²t</i> 615 is reached, the warning message "A0200" is signaled from the active data set. If the fixed threshold values exceed 100% _{motor} (120% _{stator}), the drive switches off with fault "F0401" in the active dataset. Both incidences are triggered from the active dataset.

608 Thermal time constant motor

609 Thermal time constant rotor

615 Warning limit motor I²t

The thermal time constant of the motor is in the range from few minutes to a couple of hours.

This motor-specific parameter is set via *Thermal time constant motor* **608**.

Substantially smaller is the thermal stator time constant. To protect the stator winding additional monitoring is required which is determined by *Thermal time constant stator* **609**.

These values can be taken from the corresponding motor data sheets.

When estimated time constants are used because the required data are not available then an optimal thermal motor protection cannot be guaranteed.

A warning limit allows the user to prevent an imminent I²t-fault trip through appropriate measures.

Warning limit motor I²t **615** is used to set the warning signal between 6% and 100% of thermal capacity.

Parameters		Setting			
No.	Description	Control level	Min	Max	Fact. setting
608	Thermal time constant Motor	1 in AGL 3 in ACU	1 min	240 min	30 min
609	Thermal time constant Stator	1 in AGL 3 in ACU	1 s	600 s	15 s
615	Warning Limit Motor I ² t	1 in AGL 3 in ACU	6%	100%	80%

Output signals

Digital signals signal that of the function " motor protection " has been triggered.

180 -	Warning motor	1)	Triggering of the function " motor protection " according to <i>Operation Mode 571</i> is signaled.
14 -	protection	2)	

1) For linking to frequency inverter functions

2) For output via a digital output. Select the signal source for one of the parameters 531, 532, 533, 554. See chapter 7.6.5 "Digital outputs".

7.10.7 V-belt monitoring

581 Operation Mode (V-belt monitoring)

582 Trigger Limit Iactive

583 Delay Time

Continuous monitoring of the load behaviour and thus of the connection between the 3-phase machine and the load is the task of the V-belt monitoring system. Parameter *Operation Mode* **581** defines the functional behaviour if the *Active Current* **214** or the torque-forming current component *Isq* **216** (field -orientated control method) drops below the set *Trigger Limit Iactive* **582** for a time longer than the set *Delay Time* **583**.

<i>Operation Mode 581</i>	Function
0 - Off	The function is deactivated. Factory setting.
1 - Warning	If the active current drops below the threshold value, the warning "A8000" is displayed.
2 - Error	The unloaded drive is switched off and fault message "F0402" is displayed

The error and warning messages can be output via the digital outputs (Signal 22 - "Warning V-Belt") and transmitted to an overriding controller, for example. The *Trigger Limit Iactive* **582** is to be parameterized as a percentage of the *Rated Current* **371** for the application and the possible operating points.

Parameters		Setting		
No.	Description	Min.	Max.	Fact. sett.
582	Trigger Limit Iactive	0.1%	100.0%	10.0%
583	Delay Time	0.1 s	600.0 s	10.0 s

7.10.8 Traverse function

With the traverse function, a triangle-shaped frequency signal with the start-up and shut-down times to be set is superimposed on the output frequency. The resulting chronological order of the reference frequency of master drive and slave drive are shown in the following diagrams. The function can be used, for example, for drives which wind up thread on coils in textile machines. To avoid winding errors at the turning point of the thread guide, a proportional step is performed which causes a quick speed change.

435 Operation Mode (Traverse function)

Via parameter *Operation Mode* **435**, the drive is configured as a master drive or slave drive.

<i>Operation mode 435</i>	Function
0 - Off	The traverse function is deactivated. Factory setting.
1 - Master drive	Operation as master drive.
2 - Slave drive	Operation as slave drive.

- 436 Ramp-up Time
- 437 Ramp-down Time
- 438 Traverse Amplitude
- 439 Proportional Step

In the case of the master drive, the superimposed traverse frequency is linearly opposite to the limit *Traverse Amplitude* **438** and then reverses its direction. When the direction is reversed, a proportional step is effected. Via a handshake signal, the master drive informs the slave drive that the traverse output has changed its direction. The traverse function of the slave drive has the same gradient as the traverse function of the master drive, but an opposite sign. When the slave drive reaches the limit *Traverse Amplitude* **438** before switch-over of the handshake signal, the frequency is maintained until switch-over is effected. If the handshake signal is received before the frequency limit is reached, the direction is reversed immediately.

The Percentage values of *Traverse Amplitude* **438** and *Proportional Step* **439** refer to the current frequency value set up by *Reference Frequency* **48**.

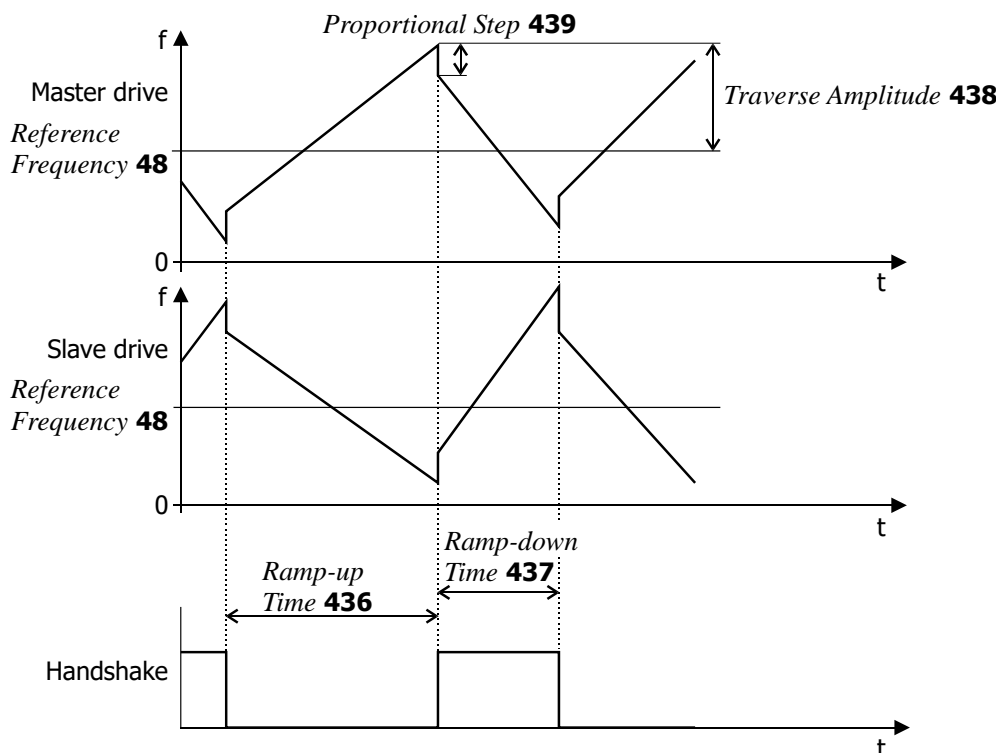

Parameters		Setting		
No.	Description	Min.	Max.	Fact. sett.
436	Ramp-up Time	0.01 s	320.00 s	5 s
437	Ramp-down Time	0.01 s	320.00 s	5 s
438	Traverse Amplitude	0.01%	50.00%	10%
439	Proportional Step	0.00%	50.00%	0.01%

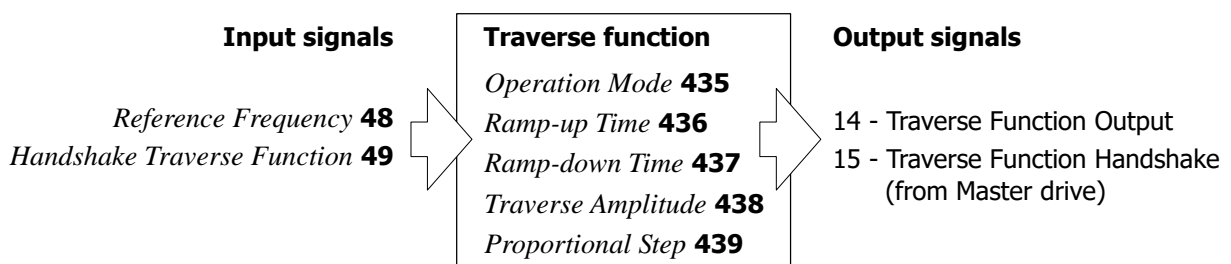

Signal "14 - Traverse Function Output" is added to the reference frequency value. During traverse operation, the configured traverse parameter values cannot be changed.

The source of the handshake signal is selected via *Handshake Traverse Function 49*.

48 Reference Frequency

For traverse mode, the reference value source is selected via parameter *Reference Frequency 48*.

Traverse mode becomes active when *Operation Mode 435* is switched on. In traverse mode, the values for *Ramp-up Time 436* and *Ramp-down Time 437* are active.

<i>Reference Frequency 48</i>	
0 - Ramp output (factory setting)	93 - Slip compensation
1 ... 5 - Fixed frequencies 1 ... 4	109 - Udc-controller
9 - Zero	115 ... 118 - Fixed frequencies 5 ... 8
10 - Stator frequency	154 - Reference ramp value
12 - Tech. controller freq. output	155 - Actual speed
14 - Traverse function output	230 - Internal reference frequency
16 - I-limit output	288 - Repetition frequency input
21 - Rotor frequency	688 - Electronic gear output
50 - Reference analog value MFI1A	708 ... 738 - RxPDO Long (system bus)
51 - Reference analog value MFI2A	774, 775 - Out-F PDPconv-long (Profibus)
56 - PWM Input	2501 ... 2504 - PLC-output frequency 1 ... 4
62 - Reference frequency channel	

⚠ WARNING

The frequency range for traverse mode is added additional to the frequency reference. Therefore the added frequency can result in values smaller than *Minimum Frequency 418* or bigger than *Maximum Frequency 419*.

To prevent too high frequencies, the summed frequency is limited:

<i>Maximum Frequency 419</i>	<i>Limitation of the summed Frequency</i>
<i>Maximum Frequency 419</i> ≤ 100 Hz	<i>Maximum Frequency 419</i> +20 Hz
<i>Maximum Frequency 419</i> ≥ 100 Hz	<i>Maximum Frequency 419</i> x 1.2

Traverse function with Setting *Reference Frequency 48* 0 – Ramp output:

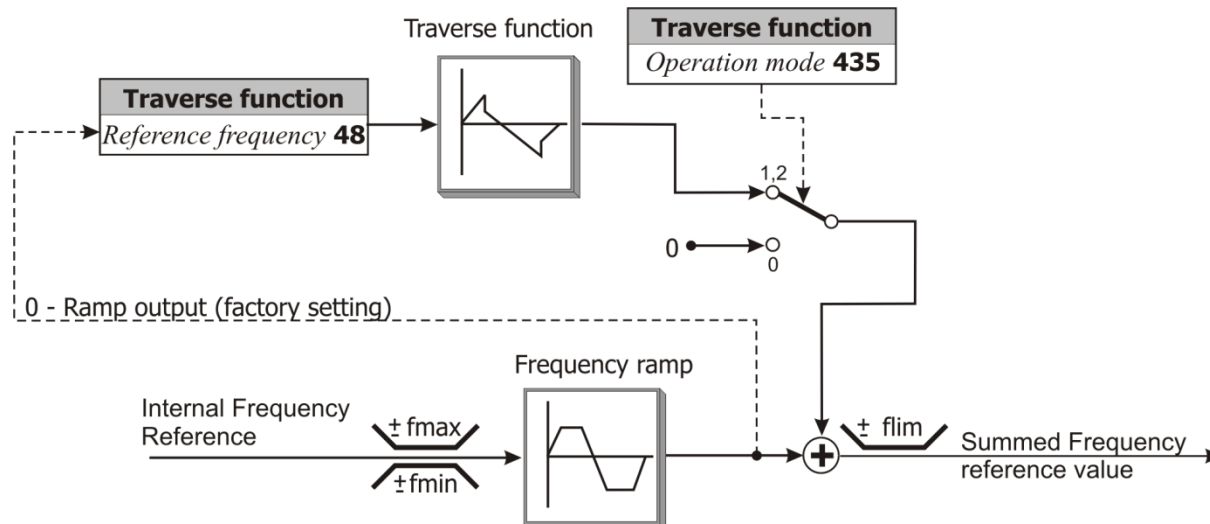

7.10.9 System data

For monitoring the application, process parameters are calculated from electrical control parameters.

389 Factor Actual System Value

1543 Base Parameter Actual System Value

Actual values (e.g. actual frequency, torque) can be scaled. The drive can be monitored via the actual value *Actual System Value 242*.

The actual value to be monitored and scaled must be selected. For parameter *Base Parameter Actual System Value 1543*, the number of the actual value parameter must be set. The value of the actual value parameter is multiplied by the *Factor Actual System Value 389* and can be read out via parameter *Actual System Value 242*.

Actual System Value 242 = (actual value from parameter **1543**) x *Factor Actual System Value 389*

Parameters		Setting		
No.	Description	Min.	Max.	Fact. sett.
389	Factor Actual System Value	-100.000	100.000	1.000

Parameters		Setting			
No.	Description		Min.	Max.	Fact. sett.
1543	Base Parameter Actual System Value	Parameter number of actual value	0	1600	241 (Actual frequency)

Factory setting:

Actual System Value 242 = (*Actual Frequency 241*) x 1.000

- Set an actual value (parameter number) in parameter *Base Parameter Actual System Value 1543*.
- Set a factor in parameter *Factor Actual System Value 389*.

Parameter *Actual System Value 242* shows the scaled actual value.

7.10.10 Service interval monitoring

Refer to chapter 10.3 "Monitoring of service interval".

7.10.11 Copy parameters

Parameter values can be saved on a memory card via operator panel or via PC control software VPlus.

NOTE:

Field bus communication is not possible or faulty during data storage or data reading by means of the memory card.

NOTE:

To use the copy function, use the memory card ("Resource pack") offered by KÜENLE ANTRIEBSSYSTEME.

KÜENLE ANTRIEBSSYSTEME doesn't take any responsibility for the malfunctioning of the memory cards of other manufacturers.

7.10.11.1 Copying using the operator panel

Storage on a memory card

Parameter values of a frequency inverter can be saved on standard digital memory cards (KÜENLE ANTRIEBSSYSTEME "Resource Pack") and uploaded on another frequency inverter.

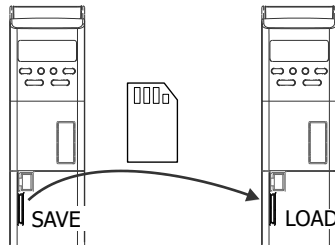

SAVE Save parameter values in a file on the memory card.

- On the operator panel in menu "Copy", select item "Save".
- Confirm by pressing "ENT". The number of the next available file is displayed.
- Confirm by pressing "ENT". The parameter values are copied to the file on the memory card.

A progress indicator indicates the parameter numbers the values of which are currently copied to the memory card.

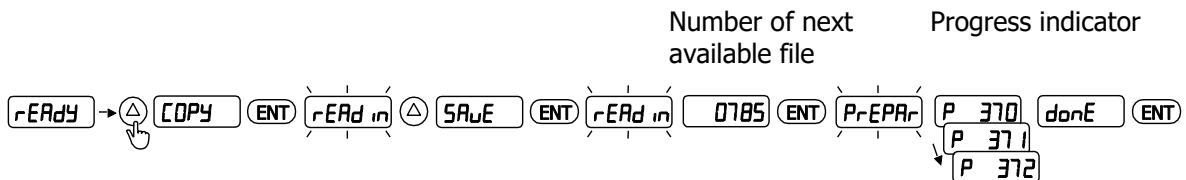

Please note, that always the highest existent number on the memory card is used to determine the next free data file number.

New Data file number = Highest existent Data file number + 1

If a file with number 9999 already exists, the data set to be stored cannot be stored correctly. Always take care, that at least number 9999 is available before Saving.







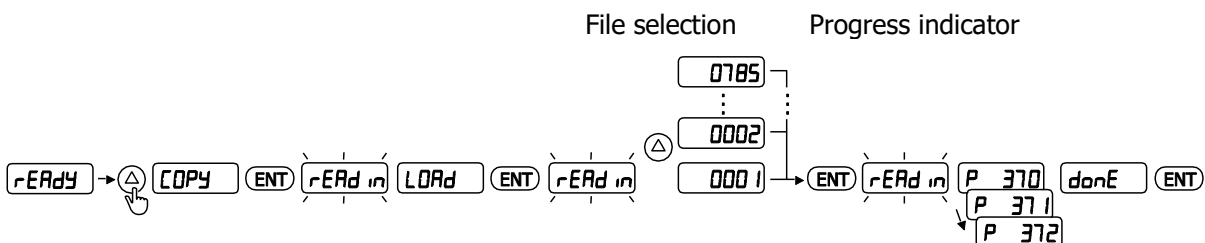









LOAD Uploading parameter values from memory card to a frequency inverter.

- On the operator panel in menu "Copy", select item "Load".
- Confirm by pressing "ENT". Using the arrow buttons, select the file you want to upload to the frequency inverter.
- Confirm by pressing "ENT". The parameter values of the selected file are uploaded to the frequency inverter.

A progress indicator indicates the parameter numbers the values of which are currently uploaded to the frequency inverter.



Messages

	No memory card plugged.
	No file with parameter values on memory card.
	Parameter values were saved on memory card. Parameter values were uploaded to frequency inverter.
	Insufficient memory. The parameter values were not copied to the memory card completely.
	No more file numbers available.
	Error while writing on the memory card.
	Error while reading from the memory card.
	Data content invalid.
	Fault when loading from memory card, memory card has contact problems. Contact mounting of card.
	Error while writing parameters of LOAD functions. Non-permissible parameter value.
	Error while writing parameters of LOAD functions. Non-permissible parameter set.
	Error while writing parameters of LOAD functions. Non-permissible write access.
	Error while writing parameters of LOAD functions. Write error EEPROM.
	Error while writing parameters of LOAD functions. Checksum error EEPROM.
	Error while writing parameters of LOAD functions. Value is only allowed to be written at inhibited state.
	Error while writing parameters of LOAD functions. Error parameter type.
	Error while writing parameters of LOAD functions. Unknown parameter. The mentioned parameter is not contained inside the target device.

If an error occurs in the LOAD function while the parameters are written, the error number and the parameter number will be displayed alternately.

- Press button "ENT" to continue the function.
- Press button "ESC" to cancel the function.



Please check the compatibility of different firmware versions when copying parameter sets between different devices. When copying from a device with a newer firmware version into devices with older firmware versions in individual cases the warning message "Err 111" may appear.

The market software of the KFU device series is downward compatible. Data from devices with older firmware versions can be transferred to devices with newer firmware.



Parameters are always saved in control level 3 "Professional" on the memory card. This is independent of the currently selected control level.

7.10.11.2 Copying using the PC control software

Parameter values can be saved on standard digital memory cards (KÜENLE ANTRIEBSSYSTEME "Resource Pack") using the PC control software VPlus and uploaded on a frequency inverter.

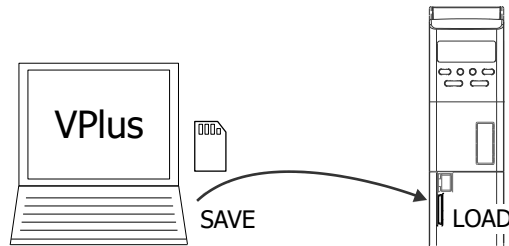

Activate in the Saving mask for the usage on a MMC card always the function "Save to Multimedia Card". To save a file for a MMC card only file names in the range from 0001 to 9999 are allowed to be used. The file names must be entered in the format "four-digit" + file extension for the usage on a MMC card.



Please note, that when storing via VPlus always the parameters of the selected control level are stored. KÜENLE ANTRIEBSSYSTEME recommends to read out the frequency inverter in control level 3 in VPlus before storing the file.

7.10.12 Converter Profibus from/to Internal Notation

- 1370 In-F-PDP-word 1
- 1371 In-F-PDP-word 2
- 1372 In-F-intern-long 1
- 1373 In-F-intern-long 2
- 1374 In-F-Convert Reference

The Converter Profibus/Internal notation can convert a 16 bit Word into an internal 32 Bit frequency value and vice versa. This is useful in example, when several devices are linked together via Systembus and for commercial reasons only one device is equipped with a Profibus Option. Through the routing of the Profibus Word via the Systembus ("Tunneling") the necessary bandwidth can be reduced and the parameterization of the "Gateway" (Systembus Master with Profibus Slave communication) be simplified. The converter is used in this case in a device without Profibus module to convert the Profibus Notation into an internal reference value.

A similar procedure can be used to convert in example the Actual Frequency into a value according to Profibus notation.

The converter can also be used for other purposes, in example when using the internal PLC programming.

In-F-PDP-word 1 **1370** and *In-F-PDP-word 2* **1371** convert the Profibus Notation into the internal Frequency. 0x4000 in Profibus-Notation (=100 %) refers to *In-F-Convert Reference* **1374** in Hz.

In-F-intern-long 1 **1372** and *In-F-intern-long 2* **1373** convert an internal frequency value into Profibus Notation. 0x4000 in Profibus-Notation (=100 %) refers to *In-F-Convert Reference* **1374** in Hz.

The Profibus Notation is limited to values from -200 % (0x8000) to +200 % (0x7FFF).

0x4000	= 100 %	= <i>In-F-Convert Reference</i> 1374
0x7FFF	= 200 %	= <i>2x In-F-Convert Reference</i> 1374
0x8000	= -200 %	= <i>-2x In-F-Convert Reference</i> 1374
0xC000	= -100 %	= <i>-In-F-Convert Reference</i> 1374

The values converted this way can be used as internal source.

- 774 – Out-F-PDP-Conv1-long1 as output of *In-F-PDP-word 1* **1370** (Profibus-Not. → Frequency)
- 775 – Out-F-PDP-Conv1-long2 as output of *In-F-PDP-word 2* **1371** (Profibus-Not. → Frequency)
- 776 – Out-F-PDP-Conv1-word1 as output of *In-F-PDP-long 1* **1372** (Frequency → Profibus-Not.)
- 777 – Out-F-PDP-Conv2-word2 as output of *In-F-PDP-long 2* **1373** (Frequency → Profibus-Not.)

8 Energy saving

Energy can be saved in a drive by reducing the losses in the electric motor or by reducing the energy consumption of the frequency inverter. In addition, the generator energy generated during braking operation can be used instead of converting it to heat.

Energy saving options

The frequency inverter offers the following energy saving options:

- Standby mode of frequency inverter
- Standby mode of operator panel
- Energy saving function: The operating point of the motor is optimized so that the power consumption is kept to a minimum.
- Quadratic V/f characteristic in the case of control of an asynchronous motor
- DC-link connection
- Energy-optimized braking
- PID controller (technology controller): When the reference value is reached, the motor is switched off.
- External DC 24 V power supply. Power supply can be switched off while the system is not in operation.
- Temperature-controlled fans
- Automatic switching frequency changeover
- In the frequency inverter, special energy saving circuitry is integrated

8.1 Energy saving function

The operating point of the motor is optimized so that the power consumption is kept to a minimum and energy saving is maximized. The energy saving function can be switched on if one of the following control methods for parameter *Configuration 30* is selected:

- "110 - IM sensor-less control" (V/f characteristic)
- "410 - IM: sensor-less field-orientated control (DMC)"

Via the following parameters, the energy saving function can be set up:

- *Operation Mode Energy Saving Function 1550*
- *Flux Reduction 1551*
- *Energy Saving Function On 1552*

The energy saving function is suitable for:

- partial load operation of a drive
- drives without high or frequent load variations

The energy saving function is not suitable for operation of a synchronous motor. The energy saving parameters cannot be set if "610 - PMSM: sensor-less field-orientated control (DMC)" is selected for parameter *Configuration 30*.

110 - IM sensor-less control (V/f characteristic)

In the case of the sensor-less control of an asynchronous motor according to the V/f characteristic, the optimum operating point of the motor is adjusted in order to keep power consumption to a minimum.

410 - IM: sensor-less field-orientated control (DMC)

In the case of the field-orientated control of an asynchronous motor, the optimum operating point of the motor is adjusted in order to keep power consumption to a minimum.

1550 Operation Mode Energy Saving Function

Parameter *Operation Mode Energy Saving Function* **1550** defines if the power consumption (magnetic flux) is reduced by an adjustable value or by an automatically determined value. Evaluation must be switched on via parameter *Energy Saving Function On* **1552**.

<i>Operation Mode Energy Saving Function</i> 1550	Function
0 - Off	Energy saving function is switched off. Factory setting.
1 - manual	Energy saving function can be switched on via a digital input or a logic signal. The digital input or the logic signal can be selected for parameter <i>Energy Saving Function On</i> 1552 . Energy is saved by reducing the flux. The value of the flux reduction can be set via parameter <i>Flux Reduction</i> 1551 .
2 - automatic	Energy saving function can be switched on via a digital input or a logic signal. The digital input or the logic signal can be selected for parameter <i>Energy Saving Function On</i> 1552 . Energy is saved by reducing the flux. The value of the flux reduction is determined automatically.

1551 Flux reduction (energy saving function)

In order to save energy, the magnetic flux is reduced by the value of *Flux Reduction* **1551**. One of the following control methods must be selected:

- *Configuration* **30** = "110 - IM sensor-less control" (V/f characteristic)
- *Configuration* **30** = "410 - IM: sensor-less field-orientated control (DMC)"

For parameter *Operation Mode Energy Saving Function* **1550**, "1 - manual" must be selected.

Parameters		Setting		
No.	Description	Min.	Max.	Fact. sett.
1551	Flux Reduction	0%	100%	0%

High values impair the dynamic behaviour of the drive.

1552 Energy Saving Function On

The signal at a digital input or a logic signal switches on the energy saving function. The digital input or the logic signal must be selected for parameter *Energy Saving Function On* **1552**.

For parameter *Operation Mode Energy Saving Function* **1550**, "1 - manual" or "2 - automatic" must be selected.

<i>Energy Saving Function On</i> 1552	Function
7 - Off	No signal for switch-on of the energy saving function. Factory setting.
71 - IN1D	The signal at digital input IN1D (terminal X11.4) switches on the energy saving function.
72 - IN2D	The signal at digital input IN2D (terminal X11.5) switches on the energy saving function.
73 - IN3D	The signal at digital input IN3D (terminal X11.6) switches on the energy saving function. For <i>Operation Mode Terminal X11.6</i> 558 "0 - Input IN3D" must be selected.
74 - IN4D	The signal at digital input IN4D (terminal X12.1) switches on the energy saving function.
75 - IN5D	The signal at digital input IN5D (terminal X12.2) switches on the energy saving function.
76 - MFI1D	The signal at multifunction input 1 (terminal X12.3) switches on the energy saving function. For <i>Operation Mode MFI1</i> 452 "3 - Digital NPN (active: 0 V)" or "4 - Digital PNP (active: 24 V)" must be selected.
77 - MFI2D	The signal at multifunction input 1 (terminal X12.3) switches on the energy saving function. For <i>Operation Mode MFI1</i> 562 "3 - Digital NPN (active: 0 V)" or "4 - Digital PNP (active: 24 V)" must be selected.
⋮	
163 - Reference Frequency reached	The energy saving function is switched on if the frequency is reached.
164 - Setting Frequency	The energy saving function is switched on if the value of <i>Setting Frequency</i> 510 is reached.

8.2 Quadratic V/f characteristic

For applications where the torque increases quadratically to the speed, e.g. control of a fan, the power consumption can be reduced and energy can be saved. In the low speed range where the full torque is not required, energy is saved.

Setting the quadratic V/f characteristic is possible if the following control method is selected for parameter *Configuration* **30**:

"110 - IM sensor-less control" (V/f characteristic)

606 Type V/f characteristic

Via parameter *Type V/f characteristic* **606**, you can switch the characteristic from linear to quadratic.

<i>Type V/f characteristic</i> 606	Function
1 - Linear	Linear V/f characteristic: $U \sim f$. Factory setting. See chapter 7.7 "V/f characteristic".
2 - Quadratic	Quadratic V/f characteristic: $ U \sim f^2$.

The quadratic characteristic follows the function: $|U| \sim f^2$.

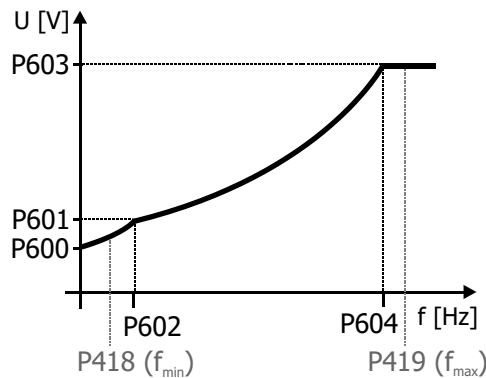

After switching over to the quadratic characteristic, the characteristic is defined by the following parameters:

- Starting Voltage **600**
- Voltage Rise **601**
- Rise Frequency **602**
- Cut-Off Voltage **603**
- Cut-Off Frequency **604**

The parameters must be adjusted to the application. Additionally, check the settings for *Starting Current* **623** and *Frequency Limit* **624**.

The parameters are described in chapters

The working range is between *Minimum Frequency* **418** and *Maximum Frequency* **419**.

8.3 Standby mode

Standby reduces the power consumption of the frequency inverter. The consumption is reduced and energy is saved.

1510 Time until Keypad Standby

The display of the operator panel is switched off if no button is pressed within the time set in parameter *Time until Keypad Standby* **1510**. Standby mode of the operator panel is indicated by a spot lighting up on the operator panel.

Standby mode is cancelled automatically if a warning or an error is signaled.

Standby mode of the operator panel is switched off if *Time until Keypad Standby* **1510** is set to zero. In this case, the display is switched on permanently.

Parameters		Setting		
No.	Description	Min.	Max.	Fact. sett.
1510	Time until Keypad Standby	0 Min	60 Min	0 Min



If the display of the operator panel is to be switched off as soon as enable of the frequency inverter is switched off – and not after a certain time – parameter *Standby Mode* **1511** can be set.

1511 Standby Mode (frequency inverter)

The frequency inverter reduces power consumption if

- the standby mode of the frequency inverter is switched on via parameter *Standby Mode* **1511**, and
- enable of the frequency inverter via digital inputs STOA and STOB is switched off

ATTENTION!



⚠ WARNING
Do not select the operation modes 11, 21 or 22, if the DC-link connection ("+" and "-" at terminal X11) of the frequency inverter is connected to other devices.



⚠ WARNING
The operation modes to switch off the I/O's (settings 12, 21 or 23) have the following effects:

- The digital inputs are no longer evaluated, the last known values remain internally (i.e. *Digital inputs 250*).
- The digital outputs are set to zero-potential, internally the values are set to zero (i.e. *Digital outputs 254*).
- The output X13.4 DC 10Vout is switched to zero-potential.
- The analogue inputs are further evaluated, (i.e. *Analog Input 251*).
- The analogue outputs are set to zero-potential, internally the values are set to zero (i.e. *Analog Output 257*).



⚠ WARNING
For the the digital inputs (settings 12, 21 or 23) of the energy saving function "Pull-up" (PNP-Logic) or "Pull-down" (NPN-Logic) resistances are switched on to minimize the internal losses. When the energy saving function is activated, the digital inputs carry up to DC 24 V (PNP-logic) or DC 0 V (NPN-logic).

KÜENLE ANTRIEBSSYSTEME recommends not to use the settings 12, 21 and 23 for the engery saving function, if:

- The digital input signals are used for KFU devices and third party products at the same time.
- The digital input signals on the wire are connected with Pull-down (PNP-logic) or Pull-up (PNP-logic) resistances to Ground or DC 24 V (in example due to interference resistance).

Standby Mode 1511	Function
0 - Off	The Standby mode of the frequency inverter is switched off. Factory setting.
1 - Step1 (=Keypad+fan)	The Standby mode is switched on. The following functions are switched off if enable is switched off: <ul style="list-style-type: none"> - the display of the operator panel¹ - the internal fans²
11 - Step1+Power unit	Standby mode is switched on. The following functions are switched off if enable is switched off: <ul style="list-style-type: none"> - the display of the operator panel - the internal fans - the power unit
12 - Step1+I/O	Standby mode is switched on. The following functions are switched off if enable is switched off: <ul style="list-style-type: none"> - the display of the operator panel - the internal fans - the digital and analog inputs and outputs³ - the voltage output DC 10 V at terminal X13.4

¹ This setting is independent of the setting of parameter *Time until Keypad Standby 1510*.

² The internal fans will continue to run for a sufficiently long time and will be switched off then.

³ The enable inputs STOA an STOB remain functional.

Standby Mode 1511	Function
13 - Step1+Communication ¹	Standby mode is switched on. The following functions are switched off if enable is switched off: <ul style="list-style-type: none"> – the display of the operator panel – the internal fans – an optional communication module
21 - Step1+Power Unit+I/O	Standby mode is switched on. The following functions are switched off if enable is switched off: <ul style="list-style-type: none"> – the display of the operator panel – the internal fans – the power unit – the digital and analog inputs and outputs – the voltage output DC 10 V at terminal X13.4
22 - Step1+ Power Unit + Comm.	Standby mode is switched on. The following functions are switched off if enable is switched off: <ul style="list-style-type: none"> – the display of the operator panel – the internal fans – the power unit – an optional communication module
23 - Step1+I/O + Communication	Standby mode is switched on. The following functions are switched off if enable is switched off: <ul style="list-style-type: none"> – the display of the operator panel – the internal fans – the digital and analog inputs and outputs – the voltage output DC 10 V at terminal X13.4 – an optional communication module
31 - Full	Standby mode is switched on. The following functions are switched off if enable is switched off: <ul style="list-style-type: none"> – the display of the operator panel – the internal fans – the digital and analog inputs and outputs – the voltage output DC 10 V at terminal X13.4 – an optional communication module – the power unit



If a fault is triggered, a deactivated keypad and a deactivated CM-Module (if existent) are switched on again.

Deactivated digital inputs are not switched on again. When the digital signals are in Standby, one of the following procedures can reset a fault:

- Reset the fault via Keypad with the STOP key
- Reset the fault via PLC (via Field bus communication)
- Set STOA and STOB to switch the device again operational and reset the fault in sequence via digital input set up in *Error acknowledgement* **103**.

8.4 Further energy saving options

DC-link connection

By DC-link connection of several frequency inverters, energy can be saved, as the energy recovered when one motor is decelerated can be used for accelerating the other drive. In this case, the acceleration energy does not have to be taken from mains supply.

If the deceleration energy from a motor is not used for accelerating the other motor it will be used for covering the consumption of the coupled frequency inverters.

¹ The operation modes for communication module switch-off can be selected only if a communication module is installed.

Energy-optimized braking

The voltage controller can be set up such that the kinetic energy recovered during deceleration operations is not converted to heat in a brake resistor. The brake ramp will be adjusted automatically such that the DC-link voltage does not exceed a certain value. The motor is decelerated in an energy-saving way. The consumption of the frequency inverter is covered by the deceleration energy of the drive, so that no energy is taken from mains supply.

The voltage controller is described in chapter 7.9.2 "Voltage controller".

PID controller (technology controller): saving energy when the reference value is reached

The PID controller (technology controller) can switch off the motor when the reference value (PID desired set value) is reached. Saving energy is possible particularly in the case of asynchronous motors, as these motors consume the magnetizing current even when they are at a standstill. The function can be used for filling level controls, for example. The function can be set up via parameter *Backlash* **618**.

See chapter 7.9.3 "PID controller (technology controller)".

External DC 24 V power supply

Via an external 24V power supply, the control component of the frequency inverter can be powered independent of mains supply. The frequency inverter can be disconnected from mains supply via contactor, for example. Even with mains supply switched off, parameterization is still possible, the function of inputs and outputs and the communication are maintained.

The power consumption of the inverter during extended interruptions of operation can almost be reduced to zero.

See chapter 5.7.6 "External DC 24 V power supply".

Temperature-controlled fans

The fans are controlled in two stages. This is done for the inside fan and the heat sink fan together. If the inside, capacitor or heat sink temperature set via *Switch-On Temperature* **39** is exceeded, the heat sink fan and the inside fan are switched on at half power. The fans will be switched off again as soon as the temperatures have dropped below the *Switch-On Temperature* **39** by 5 °C again.

If the internally defined maximum inside, DC-link capacitor or heat sink temperature thresholds are reached (5 °C below maximum temperature), the fans are switched to full power. If the temperature drops to 5 °C below the switch-on threshold again, the fans return to the half-power stage.

See chapter 7.10.2 "Fan".

The control of the fans can additionally be set via parameter *Standby Mode* **1511**.

See chapter 8.3 "Standby mode".

Automatic switching frequency changeover

The power losses of semiconductor components depend on the switching frequency and the level of the switched current. In the case of a high current load, e.g. during acceleration of high loads, the switching frequency of the pulse width modulation may be reduced temporarily in order to reduce the losses of the frequency inverter. If the current drops again after the acceleration phase, a higher switching frequency will be set automatically.

See chapter 7.10.1 "Pulse width modulation".

Circuitry measures integrated in *KFU*

The following energy saving measures were integrated in the frequency inverter and do not require any setup.

- The integrated power supply units supplying the internal assemblies are optimized to ensure minimum power losses.
- Low-loss current measurement: The own consumption of the measuring system is optimized to ensure minimum power losses.
- Supply of optional communication modules: If no communication module is connected, energy supply to the module slot is switched off.

9 Actual values

The various control functions and methods include electrical control variables and various calculated actual values of the machine or system. The different actual values can be read out for operational and error diagnosis via a communication interface or in the "Actual" menu of the operator panel.

9.1 Actual values of frequency inverter

Actual values of frequency inverter		
No.	Description	Function
222	DC-link voltage	Direct voltage in DC-link.
223	Modulation	Output voltage of the frequency inverter relative to the mains voltage (100% = U_{FIN}).
228	Internal Reference Frequency	Total of <i>Reference frequency source 1</i> 475 and <i>Reference frequency source 2</i> 492 .
229	Reference percentage	Total of <i>Reference percentage source 1</i> 476 and <i>Reference percentage source 2</i> 494 as reference value of the reference percentage channel.
230	Actual percentage value	Actual value signal at the <i>Actual percentage source</i> 478 .
243	Digital Inputs (Hardware)	Status of digital inputs in decimally encoded form: <ul style="list-style-type: none"> – of enable signal (STOA AND STOB) – of the six digital inputs – of multifunction input 1 in setting <i>Operation mode MF11</i> 452 "3 - digital NPN (active: 0 V)" or "4 - digital PNP (active: 24 V)". – of multifunction input 2 in setting <i>Operation mode MF12</i> 562 "3 - digital NPN (active: 0 V)" or "4 - digital PNP (active: 24 V)". – of digital input/output in setting <i>Operation mode terminal X11.6</i> 558 = "0 - input IN3D". Represents the status of the physical inputs (also refer to actual value <i>Digital inputs</i> 250).
244	Working hours counter	Operating hours in which the output stage of the inverter is active.
245	Operation hours counter	Operating hours of the frequency inverter in which supply voltage is available.
246	Capacitor temperature	Measured capacitor temperature. Warning or shutdown if temperature is too high.
249	Active data set	According to <i>Data set change-Over 1</i> 70 and <i>Data set change-Over 2</i> 71 of the data set currently used.
250	Digital inputs	Status of digital inputs in decimally encoded form: <ul style="list-style-type: none"> – of enable signal (STOA AND STOB) – of the six digital inputs – of multifunction input 1 in setting <i>Operation mode MF11</i> 452 "3 - digital NPN (active: 0 V)" or "4 - digital PNP (active: 24 V)". – of multifunction input 2 in setting <i>Operation mode MF12</i> 562 "3 - digital NPN (active: 0 V)" or "4 - digital PNP (active: 24 V)". – of digital input/output (terminal X11.6) in setting <i>Operation mode terminal X11.6</i> 558 = "0 - input IN3D".
251	Analog input MFI1A	Input signal at multifunction input 1. Via parameter <i>Operation mode MF11</i> 452 , multifunction input 1 must be set up as a voltage or current input.
252	Repetition frequency input	Signal on repetition frequency input according to <i>Operation mode IN2D</i> 496 .

Actual values of frequency inverter		
No.	Description	Function
253	Analog input MFI2A	Input signal at multifunction input 2. Via parameter <i>Operation mode MFI2</i> 562 , multifunction input 2 must be set up as a voltage or current input.
254	Digital outputs	s in decimally encoded form: <ul style="list-style-type: none"> – of digital output OUT1D – of multifunction output in setting <i>Operation mode MFO1 (X13.6)</i> 550 = "1 - Digital MFO1D" – of digital input/output in setting <i>Operation mode-terminal X11.6</i> 558 = "1 - output OUT3D". – of relay output
255	Heat sink temperature	Measured heat sink temperature. Warning or shutdown if temperature is too high.
256	Inside temperature	Measured inside temperature. Warning or shutdown if temperature is too high.
257	Analog output MFO1A	Output signal at multifunction output 1 in setting <i>Operation mode MFO1 (X13.6)</i> 550 = "11 - Analog (PWM) MFO1A"
258	PWM input	Pulse-width modulated signal at PWM input according to <i>Operation mode IN2D</i> 496 .
259	Actual Error	Error message with error code and abbreviation. See chapter 13.1.1 "Error messages".
269	Warnings	Warning message with warning code and abbreviation. Please note: <i>Warnings</i> 269 is not affected by <i>Create warning mask</i> 536 .
273	Application Warnings	Warning message application with warning code and abbreviation. Please note: <i>Warnings Application</i> 273 is not affected by <i>Create warning mask</i> 626 .
275	Controller Status	The reference value signal is limited by the controller coded in the controller status.
277	STO Status	Signal status of digital inputs A (STOA) and B (STOB) for enable.
278	Frequency MFO1F	Output signal at multifunction output in setting <i>Operation mode MFO1 (X13.6)</i> 550 = "20 - repetition frequency (FF) MFO1F" or "30 - Pulse Train (PT) MFO1F".
282	Reference bus frequency	Reference value from serial interface.
283	Reference ramp frequency	Reference value from reference frequency channel.
470	Revolutions	Actual value of position distance of positioning operation.
1530	Service Interval DC-link	The time remaining until next service in percent of maintenance interval. If a value of 0% is displayed, service is required. It must also be checked if a component must be replaced. Refer to chapter 10.3.1 "DC-link".
1531	Service Interval Fan	The time remaining until next service in percent of maintenance interval. If a value of 0% is displayed, service is required. It must also be checked if a component must be replaced. Refer to chapter 10.3.2 "Fan."
1533	Maintenance Note	Service status. Refer to chapter 10.3.3 "Reset service".
1541	Status device test	Service of device test. Refer to chapter 7.2.3 "Device test".



The actual values can be read out and monitored in the "Actual" menu of the operator panel.

9.1.1 STO Status

Parameter *STO Status* **277** can be used for extended diagnosis of the two digital inputs STOA and STOB for enable. The statuses of the inputs are shown in bit-encoded form.

Bit	Value	Meaning
0	1	STOA input missing.
1	2	STOB input missing.
2	4	Switch off STOA input.
3	8	Switch off STOB input.
4	16	Timeout STOA.
5	32	Timeout STOB.
6	64	Diagnosis error.
7	128	Frequency inverter error (fault).

The signal states at digital inputs STOA and STOB can be linked to functions of the frequency inverter.

70 -	Inverter Release	Enable signal of the frequency inverter via digital inputs STOA (X11.3) and STOB (X13.3). The signal is not available if parameter <i>Local/Remote</i> 412 is set to "2 - Control via Remote-Contacts".
270 -	Inverter Release inverted	Operation mode 70 inverted (LOW active).
525 -	Inverter Release(Hardware)	Enable signal of the frequency inverter via digital inputs STOA (X11.3) and STOB (X13.3).
537 -	Inverter Release(Hardware) inverted	Operation mode 525 inverted (LOW active).

9.2 Actual values of machine

The frequency inverter controls the behaviour of the machine in the various operating points. Control parameters and actual values of the machine can be displayed.

Actual values of machine		
No.	Description	Function
210	Stator Frequency	The output voltage (motor voltage) of the frequency inverter.
211	rms Current	Calculated effective output current (motor current) of the frequency inverter.
212	Output Voltage	Calculated effective value of linked output voltage (motor voltage) of frequency inverter.
213	Active Power	Active power calculated from the voltage, the current and the control variables.
214	Active Current	Active current calculated from the rated motor parameters, the control variables and the current.
215	Isd	Current component of the field-orientated control forming the magnetic flux.
216	Isq	Torque-forming current component of field-orientated control.
221	Slip Frequency	Difference from the synchronous frequency calculated from the rated motor parameters, the control variables and the current.
224	Torque	Torque at the current output frequency calculated from the voltage, the current and the control variables.
225	Rotor Flux	Current magnetic flux relative to the rated motor parameters.
226	Winding Temperature	Measured motor temperature value. Parameter <i>Operation mode motor temp.</i> 570 must be set up for temperature evaluation.
227	Act. Rotor Time Constant	Calculated value of rotor time constant.
235	Flux-Forming Voltage	Voltage component of the field-orientated control forming the magnetic flux.
236	Torque-Forming Voltage	Voltage component of the field-orientated control forming the torque.
238	Absolute Flux Value	Magnetic flux calculated according to the rated values and the operating point of the motor.

Actual values of machine		
No.	Description	Function
239	Reactive Current	Reactive current calculated from the rated motor parameters, the control variables and the current.
240	Actual Speed	Measured or calculated speed of drive.
241	Actual Frequency	Measured or calculated frequency of drive.



The actual values can be read out and monitored in the "Actual" menu of the operator panel.

9.3 Actual values of the system

The calculation of the actual figures of the system is based on the parameterized system data. Specific to the application, the parameters are calculated from the factors, electrical variables and the controls. The correct display of the actual figures is a function of the parameterized data of the system.

9.3.1 Actual system value

242 Actual System value

The drive can be monitored via the actual value *Actual system value* **242**. See chapter 7.10.9 "System data".

Actual system value		
No.	Description	Function
242	Actual System Value	Calculated actual value of drive.

9.4 Actual value memory

The assessment of the operating behaviour and the service of the frequency inverter in the application are facilitated by storing various actual values. The actual value memory guarantees monitoring of the individual variables for a definable period. The parameters of the actual value memory can be read out via a communication interface and displayed via the operator panel. In addition, the operator panel enables monitoring of the peak and mean values in the "Actual" menu branch.

Actual value memory		
No.	Description	Function
231	Peak Value Long Term Ixt	Utilization of the device-dependent overload of 60 seconds.
232	Peak Value Short Term Ixt	Utilization of the device-dependent overload of 1 second.
287	Peak Value Vdc	The maximum DC link voltage measured.
288	Average Value Vdc	The mean DC link voltage calculated in the period of observation.
289	Peak Value Heat Sink Temp.	The highest measured heat sink temperature of the frequency inverter.
290	Average Value Heat Sink Temp.	The mean heat sink temperature calculated in the period of observation.
291	Peak Value Inside Temperature	The maximum measured inside temperature in the frequency inverter.
292	Average Value Inside Temperature	The mean inside temperature calculated in the period of observation.
293	Peak Value Iabs.	The highest abs. current calculated from the measured motor phases.
294	Average Value Iabs	The mean abs. current calculated in the period of observation.
295	Peak Value Active Power pos.	Calculated maximum active power in motor operation.
296	Peak Value Active Power neg.	Calculated maximum active power in generator operation.
297	Average Value Active Power	The mean active power calculated in the period of observation.

Actual value memory		
No.	Description	Function
298	Peak Value Capacitor Temp.	Maximum measured capacitor temperature.
299	Average Value Capacitor Temp.	The mean capacitor temperature calculated in the period of observation.
301	Energy, positive	The calculated energy to the motor in motor operation.
302	Energy, negative	The calculated energy from the motor in generator operation.



The actual values can be read out and monitored in the "Actual" menu of the operator panel.

237 Reset Memory

Parameter *Reset Memory* **237** in menu "Para" of the operator panel enables resetting of the mean and peak values. The mean value and the peak value are reset to zero.

Reset Memory 237	Function
0 - No Reset	Values of actual value memory remain unchanged.
10 - Peak value long-term Ixt	Reset <i>Peak Value Long Term Ixt</i> 231 .
12 - Peak value short-term Ixt	Reset <i>Peak Value Short Term Ixt</i> 232 .
20 - Peak value Vdc	Reset <i>Peak Value Vdc</i> 287 .
21 - Average Value Vdc	Reset <i>Average Value Vdc</i> 288 .
30 - Peak value Tc	Reset <i>Peak Value Heat Sink Temp.</i> 289 .
31 - Average Value Tc	Reset <i>Average Value Heat Sink Temp.</i> 290 .
32 - Peak value Ti	Reset <i>Peak Value Inside Temperature</i> 291 .
33 - Average Value Ti	Reset <i>Average Value Inside Temperature</i> 292 .
34 - Peak Value Capacitor Temp.	Reset <i>Peak Value Capacitor Temp.</i> 298 .
35 - Average Value Capacitor Temp.	Reset <i>Average Value Capacitor Temp.</i> 299 .
40 - Peak value Iabs.	Reset <i>Peak Value Iabs</i> 293 .
41 - Average value Iabs	Reset <i>Average Value Iabs.</i> 294 .
50 - Peak value Pactive pos.	Reset <i>Peak Value Active Power pos.</i> 295 .
52 - Peak value Pactive neg.	Reset <i>Peak Value Active Power neg.</i> 296 .
53 - Average value Pactive	Reset <i>Average Value Active Power</i> 297 .
54 - Energy, positive	Reset <i>Energy, positive</i> 301 .
56 - Energy, negative	Reset <i>Energy, negative</i> 302 .
100 - All peak values	Reset all saved peak values.
101 - All average values	Reset all saved average values.
102 - All values	Reset whole actual value memory.

9.5 Actual values of the CAN system bus

Actual values of the system bus		
No.	Description	Function
978	Node-State	System bus state indication. Refer to system bus instructions.
979	CAN-State	System bus state indication. Refer to system bus instructions.

9.6 Actual values CANopen

Actual values CANopen		
No.	Description	Function
1290	Node-State	Status indication of CANopen® communication. Refer to CANopen® instructions.
1291	CAN-State	Status indication of CANopen® communication. Refer to CANopen® instructions.

9.7 Actual values Modbus and VABus

Actual values of frequency inverter		
No.	Description	Function
11	VABus SST Error Register	Modbus or VABus error register. Refer to VABus instructions.
282	Reference Bus Frequency	Reference value from serial interface.
411	Status Word	Modbus or VABus error status word. Refer to Modbus or VABus instructions.

9.8 Actual values Ethernet

Actual values of frequency inverter		
No.	Description	Function
1431	Module Info	MAC ID: physical biunique Network address

10 Service

This chapter contains information for maintaining the device.

10.1 Safety



WARNING

Any service work must be carried out by qualified staff.

Unauthorized opening and improper interventions can lead to personal injury or material damage. Repairs on the frequency inverters may only be carried out by the manufacturer or persons authorized by the manufacturer.

During any service work, comply with the documentation.

Disconnect the frequency inverter from mains voltage and protect it against being energized unintentionally.

Verify that the frequency inverter is discharged.

When the frequency inverter is disconnected from power supply, the mains, DC-link voltage and motor terminals may still be live for some time. Wait for some minutes until the DC link capacitors have discharged before starting to work at the unit.

Do not touch the terminals because the capacitors may still be charged.

If voltage supply is switched on, no covers of the frequency inverter may be removed.

After service, all covers must be installed and the terminals must be checked.

The frequency inverter complies with protection class IP20 only if the covers are mounted properly.

Avoid soiling during service work.

After service, make sure that no foreign particles (e.g. chips, dust, wires, screws, tools) are inside the frequency inverter.

Do not touch electronic components or contacts. The frequency inverter is equipped with components which are sensitive to electrostatic energy and can be damaged if handled improperly.

Only use original spare parts.



10.2 Regular service work

Cleaning instructions

- Use dry, oil-free air to remove dust.
- Use appropriate air pressure for cleaning.
- Do not use solvents for cleaning circuit boards.
- Use antistatic materials for cleaning in order to avoid electrostatic charging.

KÜENLE recommends regular maintenance of the frequency inverter. Service periods depend on the field of application and the ambient conditions.

Test/inspection object	Test/inspection and measure
Case and heat sink	<ul style="list-style-type: none"> • Remove any soiling and dust. • Check screws for tight fit, tighten if necessary. • Check component for damage and replace, if necessary.
Fan	<ul style="list-style-type: none"> • Remove any soiling and dust. • Check for unusual operating noise.
Door filter in electrical cabinet	<ul style="list-style-type: none"> • Clean or replace.
Environment	<ul style="list-style-type: none"> • Check if ambient conditions meet specifications. See chapter 11.2 "Device data".
Cooling	<ul style="list-style-type: none"> • Check if frequency inverter or motor emits excessive heat or if components change their color. In this cases: <ul style="list-style-type: none"> – Check for overload. – Check heat sink and motor for soiling. – Check ambient temperature.
Electrical cables	<ul style="list-style-type: none"> • Check cable connections for safe connection. • Check cables for damage, color changes and heat impact. • Check cable insulation and shields for wear and tear. • Replace damaged cables.
Brake resistor	<ul style="list-style-type: none"> • Check for color changes and heat impact. Check connection.

Test run after service

Check the frequency inverter in a test run (if possible).

Test/inspection	Measure
Error list and error environment	Display error via operator panel or PC software VPlus. Eliminate cause of error and acknowledge error. See chapter 13.1 "13.1".
Power supply	Measure mains voltage. Note rated values on the rating plate of the frequency inverter. Measure voltage of external DC 24 V supply (if installed). Specification: See chapter 5.7.6 "External DC 24 V power supply".
Output current	Measure output current. Check the drive system and the load behaviour if the output current is greater than the nominal value of the frequency inverter over extended periods.
Vibration or unusual noise of motor	Check the coupled load. Fix loose components.

10.3 Monitoring of service interval

During operation of electric drives, mechanical and electrical components are exposed to wear and tear. The service interval remaining until the next service (percentage of maintenance interval) of the following components can be monitored:

- DC-link of frequency inverter
- Fan of frequency inverter

1533 Maintenance Note

When the service interval until service has expired (value 0%), the frequency inverter can indicate

- via parameter *Maintenance Note* **1533** that maintenance is required or
- output a warning message

The behaviour can be set up.

The service interval remaining until service can be displayed via parameters. Service is required as soon as the remaining service interval until maintenance has expired (value 0%). It must also be checked if the component must be replaced.

10.3.1 DC-link

Signalling when service is required

The DC-link of the frequency inverter is equipped with electrolyte capacitors. The service interval for electrolyte capacitors is mainly defined by the temperature. In high temperatures the electrolytic liquid will evaporate, which reduces the capacitance of the capacitor. The temperature inside the electrolyte capacitor depends on two factors: the ambient temperature and the internal heating caused by current ripple. The temperature of the electrolyte capacitors is measured by a sensor, so that high ambient temperatures are taken into account for service interval calculation.

1534 Operation Mode Service Interval DC-link

Via parameter *Operation Mode Service Interval DC-link* **1534**, you can set how the warning is to occur when the remaining service interval until service has expired. The information can be indicated in a parameter or a service message can be output.

<i>Operation Mode Service Interval DC-link</i> 1534	Function
0 - No Action	The service interval remaining until service is monitored. The remaining service interval (in percent) can be indicated via parameter <i>Service Interval DC-link</i> 1530 . No service info or message is output.
1 - Service Parameter Message	The service interval remaining until service is monitored. The remaining service interval (in percent) can be indicated via parameter <i>Service Interval DC-link</i> 1530 . As soon as the remaining time until service has expired, parameter <i>Maintenance Note</i> 1533 will show the message "M0001 Service DC-Link". Factory setting.
2 - Alarm Message	The service interval remaining until service is monitored. The remaining service interval (in percent) can be indicated via parameter <i>Service Interval DC-link</i> 1530 . As soon as the time remaining until service has expired: <ul style="list-style-type: none"> – Parameter <i>Maintenance Note</i> 1533 will show the message "M0001 Service DC-Link". – A warning message will be output and a warning signal will be set. The warning will also be displayed on the operator panel.

Parameter *Maintenance Note* **1533** displays message "M0000" if the remaining service interval until service of the DC-link has not elapsed and no service is required.

Warning signal

Expiry of the time remaining until service is signaled.

264 -		For linking to frequency inverter functions.
50 -	Warning service DC-link	For output via a digital output. Select the signal source for one of the parameters 531, 532, 533, or 554. See chapter 7.6.5 "Digital outputs".

Operation Mode Service Interval DC-link **1534** must be set to "2 - Warning".

Time remaining until next service

1530 Service Interval DC-link

Parameter *Service Interval DC-link* **1530** indicates the service interval remaining until next service in percent. If a value of 0% is displayed, service is recommended. It should also be checked if the component must be replaced.



High ambient temperature and frequency inverter is not in operation: Even with the frequency inverter switched off, the electrolyte capacitors may age due to high ambient temperatures. The times at which the frequency inverter is switched off are not considered in the calculation of the time remaining until next service. As a result, the indicated service interval until next service may be too long.

The remaining service interval until service is an estimated value.

The remaining service interval until service (parameter *Service Interval DC-link* **1530**) can be set to 100% if setting "1 - DC-link" is selected for parameter *Reset Service Intervals* **1539**.

10.3.2 Fan

Signalling when service is required

The service interval remaining until service of the fan largely depends on the wear and tear of the bearing components. For this reason, the service interval remaining until service depends on the speed and operating time of the fan. The service interval remaining until service is calculated from these two values.

1535 Operation Mode Service Interval Fan

Via parameter *Operation Mode Service Interval Fan* **1535**, you can set how the warning is to occur when the remaining service interval until service has expired. The information can be indicated in a parameter or a service message can be output.

<i>Operation Mode Service Interval Fan</i> 1535	Function
0 - No Action	The service interval remaining until service is monitored. The remaining service interval until service can be indicated via parameter <i>Service Interval Fan</i> 1531 . No service info or message is output.
1 - Service Parameter Message	The service interval remaining until service is monitored. The remaining service interval until service can be indicated via parameter <i>Service Interval Fan</i> 1531 . As soon as the remaining time until service has expired, parameter <i>Maintenance Note</i> 1533 will show the message "M0002 Service fan". Factory setting.
2 - Alarm Message	The service interval remaining until service is monitored. The remaining service interval until service can be indicated via parameter <i>Service Interval Fan</i> 1531 . As soon as the time remaining until service has expired: <ul style="list-style-type: none"> - Parameter <i>Maintenance Note</i> 1533 will show the message "M0002 Service fan". - A warning message will be output and a warning signal will be set. The warning will also be displayed on the operator panel.

Parameter *Maintenance Note* **1533** displays message "M0000" if the remaining time until service of the fan has not elapsed and no service is required.

Warning signal

Expiry of the time remaining until service is signaled.

265 -		For linking to frequency inverter functions.
51 -	Warning service fan	For output via a digital output. Select the signal source for one of the parameters 531, 532, 533, or 554. See chapter 7.6.5 "Digital outputs".

Operation mode service interval fan **1534** must be set to "2 - Warning".

Service interval remaining until next service

1531 Service Interval Fan

Parameter *Service Interval Fan* **1531** indicates the service interval remaining until next service in percent of maintenance interval. If a value of 0% is displayed, service is required. It should also be checked if the component must be replaced.



The service interval remaining until service is an estimated value. The service interval actually remaining until next service also depends on the ambient conditions, for example. As a result, the indicated service interval until next service may be too high. Service the fan regularly. See chapter 10.2 "Regular service work".

The service interval remaining until service (parameter *Service Interval Fan* **1531**) can be set to 100% if setting "2 - fan" is selected for parameter *Reset Service Intervals* **1539**.

10.3.3 Reset service interval

1539 Reset Service Intervalsa

The remaining service interval until service (in percent) can be reset to the initial value via parameter *Reset Service Intervals* **1539**.

<i>Reset Service Intervals</i> 1539	Function
0 - No Action	No service interval remaining until service is reset.
1 - Reset Service Interval DC-Link	The service interval remaining until service of the DC-link is reset. Parameter <i>Service Interval DC-link</i> 1530 indicates 100% again.
2 - Reset Service Interval Fan	The service interval remaining until service of the fan is reset. Parameter <i>Service Interval Fan</i> 1531 indicates 100% again.

11 Technical data

This chapter contains the technical data of the KFU series.

11.1 General technical data

CE conformity	The frequency inverters <i>KFU</i> meet the requirements of the low voltage directive 2006/95/EEC and EN 61800-5-1.
EMC directive	For compliance with standard 2004/108/EC, comply with installation instructions in this document.
Interference immunity	The frequency inverters <i>KFU</i> meet the requirements of EN 61800-3 for use in industrial environments.
UL Approval	Devices that are marked with the UL proof label fulfill the requirements according to UL508c.
Ambient temperature	Operation: 0...55 °C; as from 40 °C power reduction should be considered.
Environmental class	Operation: 3K3 (EN60721-3-3), maximum relative humidity 85%, no water condensation.
Degree of protection	IP20 if covers and connection terminals are used properly.
Altitude of installation	Up to 1000 m at rated specifications. Up to 3000 m at reduced power.
Storage	Storage according to EN 50178. KÜENLE recommends that the unit be connected to mains voltage for 60 minutes after one year, at the latest.
Overload capacity (O _c)	Continuous operation 100% I _N Up to 150% I _N for 60 s Up to 200% I _N for 1 s Overload capacity can be used every 10 minutes.
Vibration and shock resistance	
Sine	According to DIN EN 60068-2-6 Fc
Shock / Half-Sine	According to DIN EN 60068-2-27 Ea
Functions	<ul style="list-style-type: none"> – Control methods adjusted to motors and application (configuration) – Adjustable speed/torque control – Various protection functions for motor and frequency inverter – Positioning relative to a reference point – Flying Start function – S-ramps for jerk limitation during acceleration and deceleration – PID controller (technology controller) – Parameterizable Master-Slave operation via system bus – Error memory – Simplified and extended control via PC (commissioning, parameterization, data set backup, diagnosis with Scope) – Energy saving function – Automatic service messages – Self-learning controllers – Communication: System bus, CANopen®, Modbus and VABus. Profibus with optional communication module.
Parameterization	<ul style="list-style-type: none"> – Freely programmable digital inputs and outputs – PLC functions, can be realized via table functions or a graphical PC user interface – Four separate data sets incl. motor parameter – Pre-defined motor data KÜENLE motors

11.2 Device data

This chapter contains the Technical data of the different sizes of the KFU series.

KFU A2- / A4-

General are valid for KFU A2 and KFU A4 devices are the following characteristics:

Output motor side			
Output voltage	U	V	Maximum value of input voltage, three-phase
Protection	-	-	Short circuit proof and earth fault proof
Rotary field frequency	f	Hz	0 ... 1000, depending on switching frequency
Integrated brake chopper	-	-	yes
Input mains side			
Mains configuration	-	-	TT, TN, IT
Mains voltage range	U	V	KFU A2: 230 (-20 %) ... 240 (+10 %) KFU A4: 380 (-15%) ... 480 (+10%)
Mains frequency	f	Hz	45 ... 69
Overvoltage category	-	-	EN 50178 III, EN 61800-5-1 III
Ambient conditions			
Cooling agent temperature (air)	T _n	°C	0 ... 40 (EN 60721-3-3), 40 ... 55 with power reduction (derating)
Storage temperature	T _L	°C	-25 ... 55
Transport temperature	T _T	°C	-25 ... 70
Relative air humidity	-	%	Operation: maximum 85 Storage: 5 ... 95
			non-condensing



KFU A2 devices in the sizes 1 to 3 can be operated either with single phase or three phase connection. In single phase operation a lower power compared to three phase operation is available. The type codes correlate to the three phase power.

11.2.1 KFU A2 (3~:0.18 to 0.55 kW, 1~:0.09 to 0.25 kW, 230 V)

Type										
			230 V							
KFU A2										
Size										
1										
Output motor side										
Selected Mains supply			1ph	3ph	1ph	3ph	1ph	3ph	1ph	3ph
Recommended motor shaft power	P	kW	0.09	0.18	0.12	0.25	0.18	0.37	0.25	0.55
Output current	I	A	0.8	1.3	1.0	1.5	1.3	2.0	1.5	3.0
Long-term overload current (60 s)	I	A	1.2	2	1.5	2.25	1.95	3.0	2.25	4.5
Short-time overload current (1 s)	I	A	1.6	2.6	2.0	3	2.6	4.0	3.0	6.0
Switching frequency	f	kHz	2, 4, 8, 16							
Output, brake resistor										
Minimum brake resistor	R	Ω	100	100	100	100	100	100	100	100
Recommended brake resistor (385 V)	R	Ω	300	220	250	200	220	140	200	100
Input mains side										
Rated current	I	A	1.7	1.2	1.9	1.4	2.5	2.0	3.0	2.5
Maximum mains current ¹⁾	I	A	2.5	2.2	2.9	2.5	3.6	3.3	4.2	4.0
Fuses	I	A	6	6	6	6	6	6	6	6
Fuses UL type	I	A	Bussmann FWP-10A14Fa							
Mechanics										
Dimensions ²⁾	HxWxD	mm	200 x 60 x 170							
Weight (approx.)	m	kg	1.1							
Degree of protection	-	-	IP20 (EN60529)							
Terminals	A	mm ²	Mains and motor terminals:	0.2 ... 4 (flexible with sleeve) 0.2 ... 6 (rigid)						
			Terminals relay output:	0.1 ... 1.5						
Installation	-	-	vertical							
Interior fan	-	-	no							
Heat sink fan	-	-	no							
Ambient conditions										
Power dissipation (2 kHz switching frequency)	P	W	12	12	19	19	29	29	42	42

1) According to DIN EN 61800-5-1.

2) Dimensions of the basic device. Comply with the notes of the assembly variants in chapter 4.2 "Installation" for the standard assembly and chapter 12.9 "Assembly variants".

KFU A2- / A4-

11.2.2 KFU A2 (3~:0.75 to 2.2 kW, 1~:0.37 to 1.1 kW, 230 V)

Type										
			230 V							
KFU A2										
Size			1							
Output motor side										
Selected Mains supply			1ph	3ph	1ph	3ph	1ph	3ph	1ph	3ph
Recommended motor shaft power	P	kW	0.37	0.75	0.55	1.1	0.75	1.5	1.1	2.2
Output current	I	A	2.0	3.5	3.0	5.0	3.5	6.0	5.0	9.0
Long-term overload current (60 s)	I	A	3.0	5.25	4.5	7.5	5.25	9.0	7.5	13.5
Short-time overload current (1 s)	I	A	4.0	7.0	6.0	10	7.0	12.0	10.0	18.0
Switching frequency	f	kHz	2, 4, 8, 16							
Output, brake resistor										
Minimum brake resistor	R	Ω	100	100	100	100	37	37	37	37
Recommended brake resistor (385 V)	R	Ω	100	100	100	100	92	63	70	41
Input mains side										
Rated current	I	A	4.2	3.4	5.3	4.9	7.6	6.5	11.2	9.5
Maximum mains current ¹⁾	I	A	5.5	5.1	6.9	6.7	11.4	10.8	15.5	14.5
Fuses	I	A	6	6	6	6	10	10	16	16
Fuses UL type	I	A	Bussmann FWP-10A14Fa							
Mechanics										
Dimensions ²⁾	HxWxD	mm	200 x 60 x 170							
Weight (approx.)	m	kg	1.1							
Degree of protection	-	-	IP20 (EN60529)							
Terminals	A	mm ²	Mains and motor terminals:	0.2 ... 4 (flexible with sleeve) 0.2 ... 6 (rigid)						
			Terminals relay output:	0.1 ... 1.5						
Installation	-	-	vertical							
Interior fan	-	-	no							
Heat sink fan	-	-	yes							
Ambient conditions										
Power dissipation (2 kHz switching frequency)	P	W	53	53	70	70	89	89	122	122

1) According to DIN EN 61800-5-1.

2) Dimensions of the basic device. Comply with the notes of the assembly variants in chapter 4.2 "Installation" for the standard assembly and chapter 12.9 "Assembly variants".

11.2.3 KFU A2 (3~:3.0 to 4.0 kW, 1~:1.5 to 2.2 kW, 230 V)

Type						
			230 V			
KFU A2						
Size						
2						
Output motor side						
Selected Mains supply			1ph	3ph	1ph	3ph
Recommended motor shaft power	P	kW	1.5	3.0	2.2	4.0
Output current	I	A	6.0	12.0	9.0	15.0
Long-term overload current (60 s)	I	A	9.0	18.0	13.5	22.5
Short-time overload current (1 s)	I	A	12.0	24.0	18.0	30.0
Switching frequency	f	kHz	2, 4, 8, 16			
Output, brake resistor						
Minimum brake resistor	R	Ω	18.5	18.5	18.5	18.5
Recommended brake resistor (385 V)	R	Ω	72	37	41	27
Input mains side						
Rated current	I	A	14.2	12.5	19.5	17.0
Maximum mains current ¹⁾	I	A	20.6	18.5	28.0	25.5
Fuses	I	A	16	16	25	25
Fuses UL type	I	A	Bussmann FWP-20A14Fa			
Mechanics						
Dimensions ²⁾	HxWxD	mm	200 x 80 x 196			
Weight (approx.)	m	kg	1.5			
Degree of protection	-	-	IP20 (EN60529)			
Terminals	A	mm ²	Mains and motor terminals:	0.2 ... 4 (flexible with sleeve)		
			Terminals relay output:	0.2 ... 6 (rigid)		
				0.1 ... 1.5		
Installation	-	-	vertical			
Interior fan	-	-	yes			
Heat sink fan	-	-	yes			
Ambient conditions						
Power dissipation (2 kHz switching frequency)	P	W	133	133	167	167

1) According to DIN EN 61800-5-1.

2) Dimensions of the basic device. Comply with the notes of the assembly variants in chapter 4.2 "Installation" for the standard assembly and chapter 12.9 "Assembly variants".

KFU A2- / A4-

11.2.4 KFU A2 (3~:5.5 to 7.5 kW, 1~:3.0 kW, 230 V)

Typ						
			230 V			
KFU 202						
Size						
3						
Output motor side						
Selected Mains supply			1ph	3ph	1ph	3ph
Recommended motor shaft power	P	kW	3.0	5.5	3.0	7.5
Output current	I	A	12.0	21.0	12.0	26.0
Long-term overload current (60 s)	I	A	18.0	31.5	18.0	39.0
Short-time overload current (1 s)	I	A	24.0	42.0	24.0	44.0
Switching frequency	f	kHz	2, 4, 8, 16			
Output, brake resistor						
Minimum brake resistor	R	Ω	18.5	18.5	18.5	18.5
Recommended brake resistor (385 V)	R	Ω	32	19	32	18.5
Input mains side						
Rated current	I	A	26.7	22.5	26.7	30.0
Maximum mains current ¹⁾	I	A	40.0	33.0	40.0	41.5
Fuses	I	A	35	35	35	35
Fuses UL type	I	A	Bussmann FWP-30A14Fa			
Mechanics						
Dimensions ²⁾	HxWxD	mm	200 x 125 x 205			
Weight (approx.)	m	kg	3			
Degree of protection	-	-	IP20 (EN60529)			
Terminals	A	mm ²	Mains and motor terminals:	0.2 ... 4 (flexible with sleeve)		
			Terminals relay output:	0.2 ... 6 (rigid)		
				0.1 ... 1.5		
Installation	-	-	vertical			
Interior fan	-	-	yes			
Heat sink fan	-	-	yes			
Ambient conditions						
Power dissipation (2 kHz switching frequency)	P	W	235	235	235	321

1) According to DIN EN 61800-5-1.

2) Dimensions of the basic device. Comply with the notes of the assembly variants in chapter 4.2 "Installation" for the standard assembly and chapter 12.9 "Assembly variants".

11.2.5 KFU A4 (0.25 to 2.2 kW, 400 V)

Type									
		400 V, 3-phase							
KFU A4									
Size		1							
Output motor side									
Recommended motor shaft power	P	kW	0.25	0.37	0.55	0.75	1.1	1.5	2.2
Output current	I	A	0.8	1.2	1.5	2.1	3.0	4.0	5.5
Long-term overload current (60 s)	I	A	1.2	1.8	2.25	3.15	4.5	6.0	8.2
Short-time overload current (1 s)	I	A	1.6	2.4	3.0	4.2	6.0	8.0	11.0
Switching frequency	f	kHz	2, 4, 8, 16						
Output, brake resistor									
Minimum brake resistor	R	Ω	300	300	300	300	300	220	220
Recommended brake resistor (770 V)	R	Ω	2432	1594	930	634	462	300	220
Input mains side									
Rated current	I	A	0.8	1.2	1.8	2.4	2.8	3.3	5.8
Maximum mains current ¹⁾	I	A	1.1	1.5	2.0	2.7	3.9	5.2	7.3
Fuses	I	A	6	6	6	6	6	6	10
Fuses UL type	I	A	Bussmann FWP-10A14Fa						
Mechanics									
Dimensions ²⁾	HxWxD	mm	200 x 60 x 170						
Weight (approx.)	m	kg	1.1						
Degree of protection	-	-	IP20 (EN60529)						
Terminals	A	mm ²	Mains and motor terminals:	0.2 ... 4 (flexible with sleeve) 0.2 ... 6 (rigid)					
			Terminals relay output:	0.1 ... 1.5					
Installation	-	-	vertical						
Interior fan	-	-	no						
Heat sink fan	-	-	no						Yes
Ambient conditions									
Power dissipation (2 kHz switching frequency)	P	W	19	29	42	53	70	89	122

1) According to DIN EN 61800-5-1.

2) Dimensions of the basic device. Comply with the notes of the assembly variants in chapter 4.2 "Installation" for the standard assembly and chapter 12.9 "Assembly variants".

KFU A2- / A4-

11.2.6 KFU A4 (3.0 to 11.0 kW, 400 V)

Type										
			400 V. 3-phase							
KFU A4										
Size			2				3			
Output motor side										
Recommended motor shaft power	P	kW	3.0	4.0	5.5	7.5	5.5	7.5	9.2	11.0
Output current	I	A	7.5	9.5	12.0	17.0	13.0	17.0	20.0	23.0
Long-term overload current (60 s)	I	A	11.2	14.2	18.0	25.5	19.5	25.5	30.0	34.5
Short-time overload current (1 s)	I	A	15.0	19.0	24.0	34.0	26.0	34.0	40.0	46.0
Switching frequency	f	kHz	2, 4, 8, 16							
Output. brake resistor										
Minimum brake resistor	R	Ω	106	106	106	48	48	48	48	48
Recommended brake resistor (770 V)	R	Ω	148	106	106	58	80	58	48	48
Input mains side										
Rated current	I	A	6.8	7.8	13.8	15.8	14.2	15.8	20.0	26.0
Maximum mains current ¹⁾	I	A	9.8	12.8	17.2	23.0	17.2	23.0	28.1	33.6
Fuses	I	A	10	10	16	25	16	25	25	35
Fuses UL type	I	A	Bussmann FWP-20A14Fa				Bussmann FWP-30A14Fa			
Mechanics										
Dimensions ²⁾	HxWxD	mm	200 x 80 x 196				200 x 125 x 205			
Weight (approx.)	m	kg	1.5				3			
Degree of protection	-	-	IP20 (EN60529)							
Terminals	A	mm ²	Mains and motor terminals:				0.2 ... 4 (flexible with sleeve)			
			Terminals relay output:				0.2 ... 6 (rigid)			
Installation	-	-	vertical							
Interior fan	-	-	yes							
Heat sink fan	-	-	yes							
Ambient conditions										
Power dissipation (2 kHz switching frequency)	P	W	133	167	230		235	321	393	470

1) According to DIN EN 61800-5-1.

2) Dimensions of the basic device. Comply with the notes of the assembly variants in chapter 4.2 "Installation" for the standard assembly and chapter 12.9 "Assembly variants".

11.2.7 Increase of switching frequency

Increasing the switching frequency is permissible if the output current is reduced. Comply with the applicable standards and regulations for this operating point. The specified output currents are the maximum values for continuous operation.

230 V devices:

Output current										
Frequency inverter			Switching frequency. 1phase Operation				Switching frequency. 3phase Operation			
Type	Nominal Power [kW]		2 kHz	4 kHz	8 kHz	16 kHz	2 kHz	4 kHz	8 kHz	16 kHz
	1phase	3phase								
KFU A2	0.09	0.18	0.8 A	0.8 A	0.8 A	0.5 A	1.3	1.3	1.3	0.9A
KFU A2	0.12	0.25	1.0 A	1.0 A	1.0 A	0.7 A	1.5	1.5	1.5	1.0 A
KFU A2	0.18	0.37	1.3 A	1.3 A	1.3 A	0.9 A	2.0	2.0	2.0	1.3 A
KFU A2	0.25	0.55	1.5 A	1.5 A	1.5 A	1.0 A	3.0	3.0	3.0	2.0 A
KFU A2	0.37	0.75	2.0 A	2.0 A	2.0 A	1.3 A	3.5	3.5	3.5	2.3 A
KFU A2	0.55	1.1	3.0 A	3.0 A	3.0 A	2.0 A	5.0	5.0	5.0	3.3 A
KFU A2	0.75	1.5	3.5 A	3.5 A	3.5 A	2.3 A	6.0	6.0	6.0	4.0 A
KFU A2	1.1	2.2	5.0 A	5.0 A	5.0 A	3.3 A	9.0	9.0	9.0	6.0 A
KFU A2	1.5	3.0	6.0 A	6.0 A	6.0 A	4.0 A	12.0	12.0	12.0	8.0 A
KFU A2	2.2	4.0	9.0 A	9.0 A	9.0 A	6.0 A	15.0	15.0	15.0	10.0 A
KFU A2	3.0	5.5	12.0 A	12.0 A	12.0 A	8.0 A	21.0	21.0	21.0	14.0 A
KFU A2	3.0	7.5	12.0 A	12.0 A	12.0 A	8.0 A	26.0	26.0	26.0	17.3 A

400 V devices:

Output current					
Frequency inverter		Switching frequency			
Type	Type	2 kHz	4 kHz	8 kHz	16 kHz
KFU A4	0.25	0.8 A	0.8 A	0.8 A	0.5 A
KFU A4	0.37	1.2 A	1.2 A	1.2 A	0.8 A
KFU A4	0.55	1.5 A	1.5 A	1.5 A	1.0 A
KFU A4	0.75	2.1 A	2.1 A	2.1 A	1.4 A
KFU A4	1.1	3.0 A	3.0 A	3.0 A ¹⁾	2.0 A ¹⁾
KFU A4	1.5	4.0 A	4.0 A	4.0 A	2.7 A
KFU A4	2.2	5.5 A	5.5 A	5.5 A ¹⁾	3.7 A ¹⁾
KFU A4	3.0	7.5 A	7.5 A	7.5 A	5.0 A
KFU A4	4.0	9.5 A	9.5 A	9.5 A ¹⁾	6.3 A ¹⁾
KFU A4	5.5	12.0 A	12.0 A	12.0 A ¹⁾	8.0 A ¹⁾
KFU A4	5.5	13.0 A	13.0 A	13.0 A	8.7 A
KFU A4	7.5	17.0 A	17.0 A	17.0 A	11.4 A
KFU A4	9.2	20.0 A	20.0 A	20.0 A	13.4 A
KFU A4	11.0	23.0 A	23.0 A	23.0 A ¹⁾	15.4 A ¹⁾

¹⁾ Reduction of switching frequency in thermal limit range.

11.3 Control electronics

Voltage output DC 24 V			
Terminals	X11.1 (DC +24 V), X11.2 (DC 0 V)		
Maximum output current	DC 100 mA		
Voltage output DC 10 V			
Terminal	X13.4		
Maximum output current	DC 8.2 mA		
Minimum output current	DC 2.3 mA ¹		
Voltage input DC 24 V			
Terminal	X13.1 (DC 24 V), X13.2 (DC 0 V)		
Input for external power supply. ²			
Input voltage range	DC 24 V ±10%		
Rated input current	Max. DC 1.0 A (typically DC 0.45 A)		
Input peak current	Typically < DC 15 A (max. 100 µs)		
External fuse	Standard fuse elements for rated current, characteristic: slow		
Safety	Safety extra low voltage SELV according to EN 61800-5-1		
Digital inputs			
Terminals	X11.4, X11.5, X12.1, X12.2		
Signal level	PNP	High: DC 15... 24 ...30 V	Low: DC 0...5 V
	NPN	High: DC 0...5 V	Low: DC 15... 24 ...30 V
Maximum input voltage	DC 30 V (DC 6 mA at DC 24 V)		
Input resistance	3.9 kΩ		
Response time	2 ms		
Other properties	PLC compatible		
Digital inputs for enable and safety function STO			
Terminals	X11.3, X13.3		
Signal level	Low: DC 0 ... 3 V		
	High: DC 15 ... 30 V		
Maximum input voltage	DC 30 V (DC 10 mA at DC 24 V)		
Input resistance	1.8 kΩ		
Response time	Enable is activated 10 ms after triggering.		
Digital output			
Terminal	X13.5		
Output voltage	DC 22 V (DC 15 ... 28 V)		
Maximum output current	DC 100 mA ³		
Other properties	Overload and short-circuit proof, overvoltage-protected		
Digital input/output			
Terminal	X11.6		
Digital Input			
Signal level	PNP	High: DC 15... 24 ...30 V	Low: DC 0...5 V
	NPN	High: DC 0...5 V	Low: DC 15... 24 ...30 V
Maximum input voltage	DC 30 V (DC 6 mA at 24 V)		
Input resistance	3.9 kΩ		
Response time	2 ms		
Other properties	PLC compatible		
Digital output			
Output voltage	DC 24 V (DC 15 ... 30 V ^{**})		
Maximum output current	DC 100 mA [*]		
Other properties	Overload and short-circuit proof, overvoltage-protected		

¹ Depending on value at 24 VDC voltage input.

² Connect ground (GND) of external power supply to terminal X13.2 (GND).

³ The value is reduced if additional control outputs are used.

Multifunction inputs (digital/analog input)	
Terminal	X12.3, X12.4
Digital Input	
Signal level	PNP High: DC 15... 24 ...30 V (digital) Low: DC 0...5 V (digital)
	NPN High: DC 0...5 V (digital) Low: DC 15... 24 ...30 V (digital)
Maximum input voltage	DC 30 V (DC 6 mA at DC 24 V)
Input resistance	3.9 kΩ
Response time	2 ms
Other properties	PLC compatible
Voltage input (analog)	
Input voltage	DC 0 ... 10 V
Input resistance	78 kΩ
Resolution	10 Bit
Current input (analog)	
Input current	DC 0 ... 20 mA
Input resistance	250 Ω
Resolution	9 Bit
Multifunction output (digital/analog/frequency/pulse train output)	
Terminal	X13.6
Digital output	
Output voltage	DC 24 V (DC 15 ... 30 V ^{**})
Maximum output current	DC 100 mA
Other properties	Overload and short-circuit proof, overvoltage-protected
Analog output (PWM)	
Output voltage	DC 24 V (DC 15 ... 30 V ^{**})
Maximum output current	DC 100 mA [*]
Other properties	Pulse-width modulated signal $f_{PWM} = 126$ Hz
Frequency output	
Output voltage	DC 24 V (15 ... 30 V ^{**})
Maximum output current	DC 100 mA
Maximum output frequency	150 kHz
Other properties	
Pulse train output	
Output voltage	DC 24 V
Maximum output current	DC 100 mA [*]
Maximum output frequency	150 kHz

* The maximum output current of an output of 100 mA is reduced if additional control outputs are used.

** Dependent on the voltage supply of the control unit and the connected load on the different outputs. Maximum guaranteed value: 15 VDC.

Relay output (floating changeover contact)	
Terminal	X10
Contact load capacity	make contact: AC 240 V/5 A, DC 24 V/5 A (ohmic)
	break contact: AC 240 V/3 A, DC 24 V/1 A (ohmic)
Response time	40 ms

11.4 Operation diagrams

Installation height

The nominal values of the frequency inverter apply to installation altitudes up to 1000 meters above sea level¹. If the installation altitude exceeds 1000 meters, the output power and cooling agent temperature (ambient temperature) must be reduced.

Reduction of output current
Power reduction (derating).
Above 1000 m: Reduction by 5%/1000 m.
Maximum altitude 3000 m.

Reduction of cooling agent temperature
Above 1000 m: Reduction by 3.3°C/1000 m.
Maximum cooling agent temperature 55 °C.

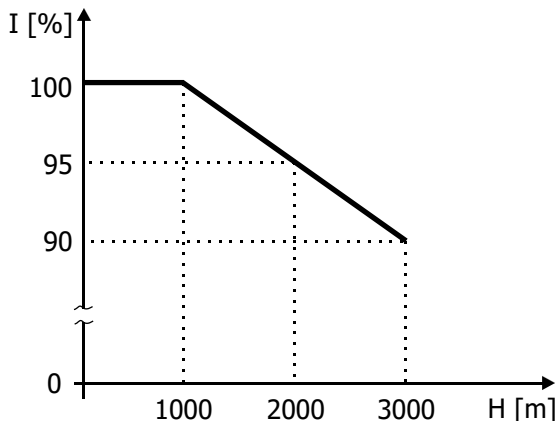

Reduction of output current I depending on installation altitude H.

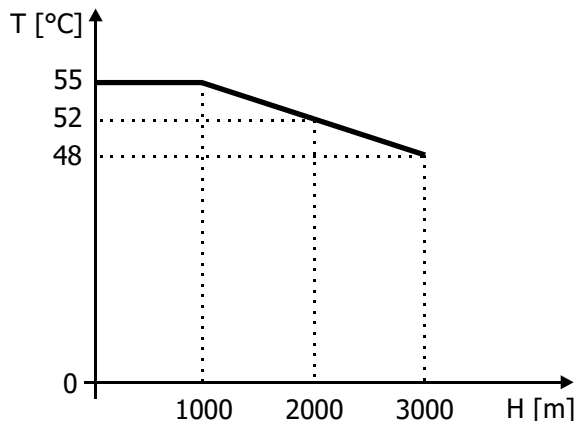

Reduction of cooling agent temperature T depending on installation altitude H.

Temperature

The nominal values of the frequency inverter apply to a cooling agent temperature between 0 and 40 °C (ambient temperature).

Reduction of output current
Power reduction (derating).
Above 40 °C: Reduction by 2.5%/K; $T_{max} = 55\text{ °C}$

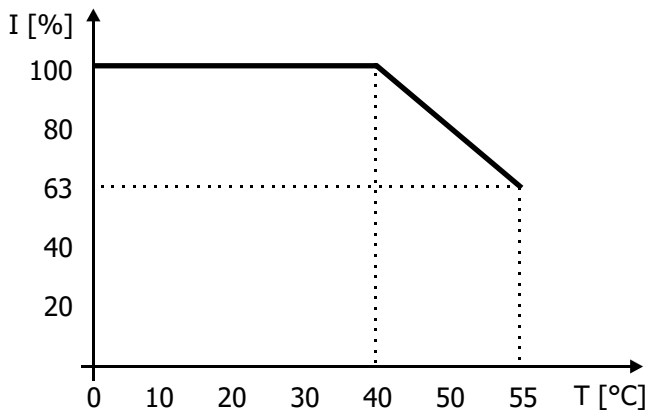

Reduction of output current I depending on cooling agent temperature T.

¹ NN: sea level

Mains voltage

Reduction of output current (Derating) at constant output power
Above 400 V: 0.22%/V, $U_{\max} = 480$ V

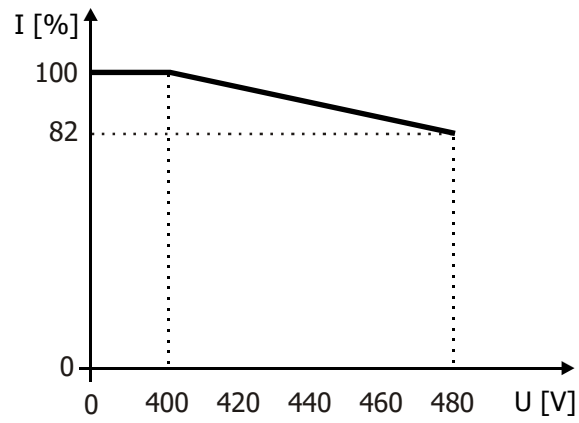

Reduction of output current I depending on output voltage U (= mains voltage).

12 Options

KÜENLE provides optional components for mechanical and electrical installation, commissioning and communication.

12.1 Safety



WARNING

To avoid serious physical injury or considerable damage to property, only qualified staff may work on the device.

The electrical installation must be carried out by qualified electricians according to the general and regional safety and installation directives.

12.2 Shield sheets

With an optional shield sheet an EMC conform cabling can be effected. Shield sheets for control cables and shield sheets for motor cables are available for each construction size.

12.2.1 Shield sheet for control cables

With an optional shield sheet, the shields of control and communication cables can be connected to PE potential. The shield sheet offers three ways of shielding the cables: by means of shielding clamp, shielding connector or shielding connection clamp.

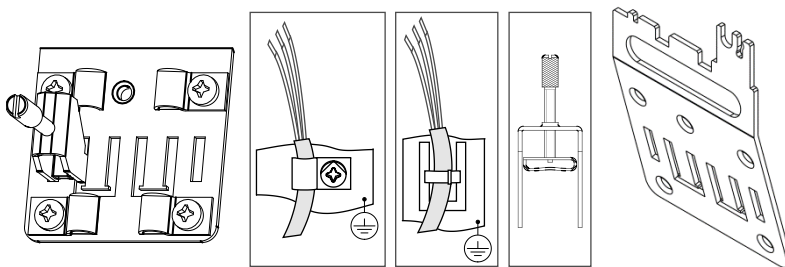

Assembly

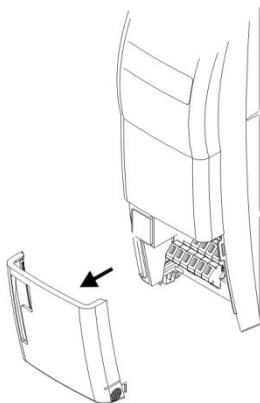

Fix the shield sheet:

- Remove the lower cover.

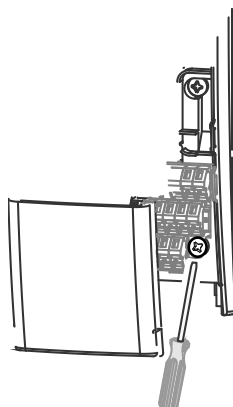

- Loosen the lower screw slightly (don't turn out completely).

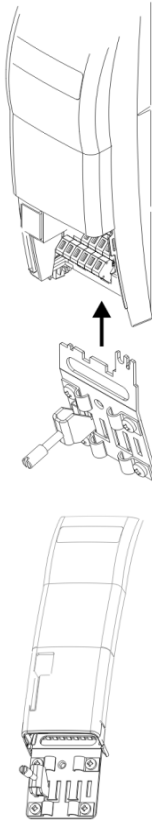

- Push the shield sheet from the bottom into the frequency inverter housing completely.
- Tighten the screw. Maximum tightening torque: 3 Nm.

- Fix the lower cover.

12.2.1.1 Dimensions

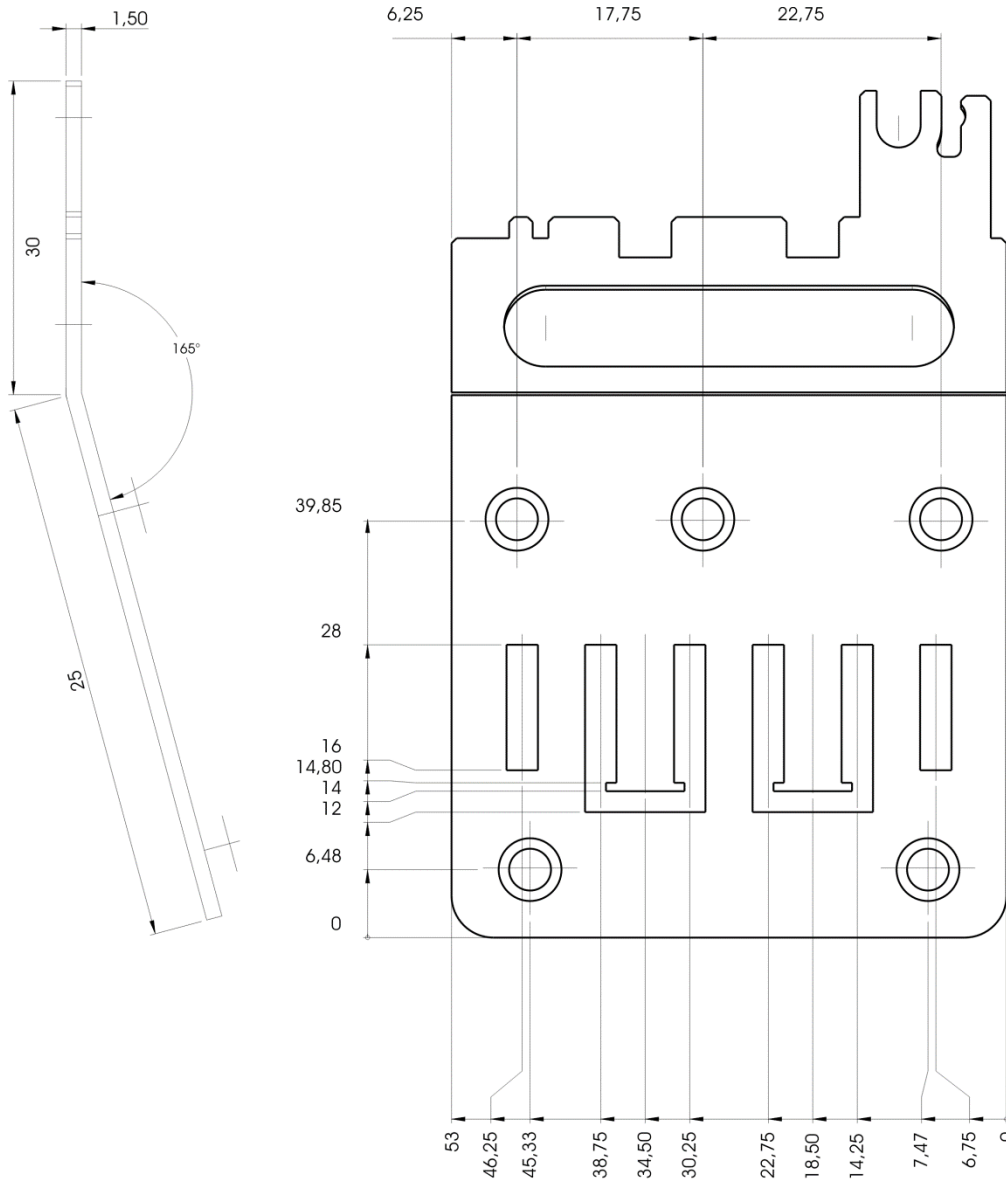

12.2.2 Shield sheet for motor cables

With an optional shield sheet, the shield of the motor cable can be connected to PE potential.

12.2.2.1 Size 1 and 2 (3~: 0.18 kW to 5.5 kW; 1~: 0.09 kW to 2.2 kW)

Valid for the following devices

Frequency inverter			
Type	KFU 202		KFU 402
Mains supply	1ph.	3ph.	3ph.
Power	kW	kW	kW
KFU	0.09	0.18	--
KFU	0.12	0.25	0.25
KFU	0.18	0.37	0.37
KFU	0.25	0.55	0.55
KFU	0.37	0.75	0.75
KFU	0.55	1.1	1.1
KFU	0.75	1.5	1.5
KFU	1.1	2.2	2.2
KFU	1.5	3.0	3.0
KFU	2.2	4.0	4.0
KFU	--	--	5.5

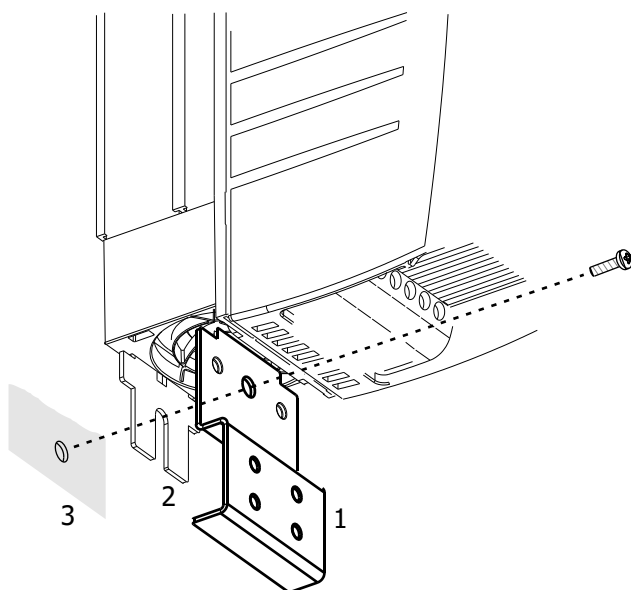

- Assemble the shield sheet (1) together with the fixing bracket (2) onto the mounting plate (3).

KFU A2- / A4-

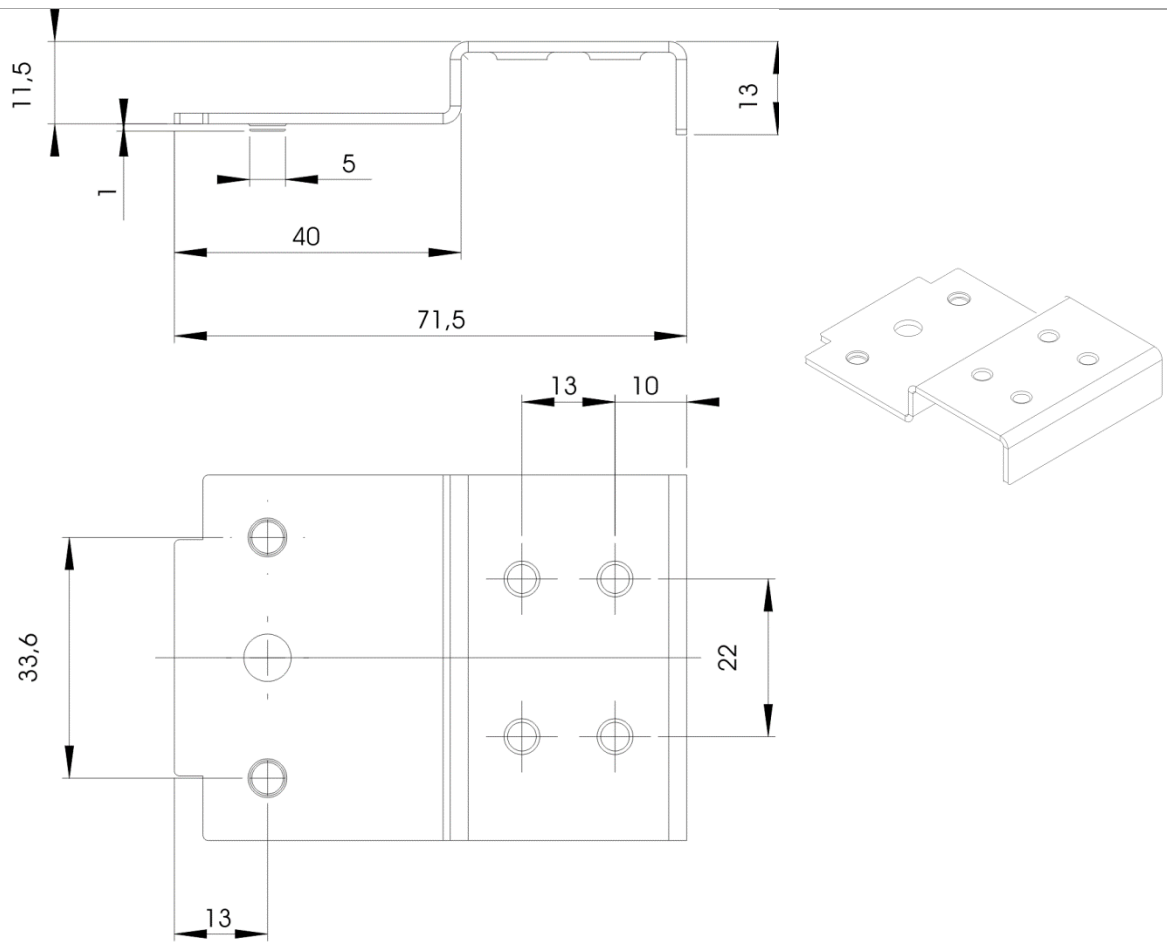

12.2.2.2 Size 3 (3~: 5.5 kW to 11.0 kW; 1~: 3kW)

Valid for the following devices

Frequency inverter			
Type	KFU 202		KFU 402
Mains supply	1ph.	3ph.	3ph.
Power	kW	kW	kW
KFU	3	5.5	5.5
KFU	3	7.5	7.5
KFU	--	--	9.2
KFU	--	--	11

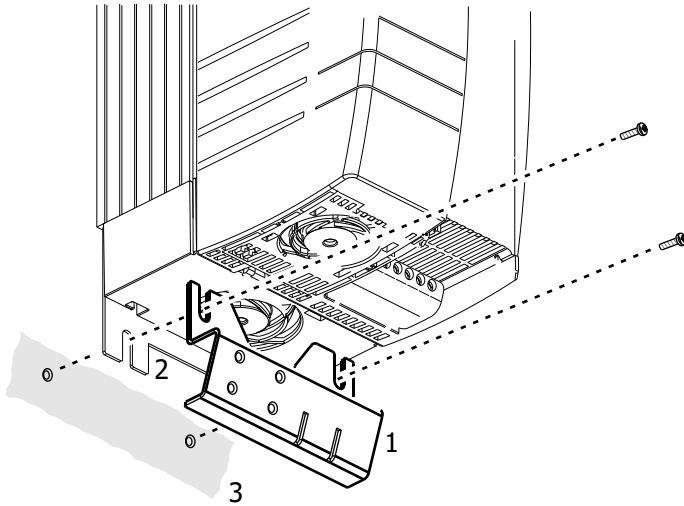

- Assemble the shield sheet (1) together with the fixing bracket (2) onto the mounting plate (3).

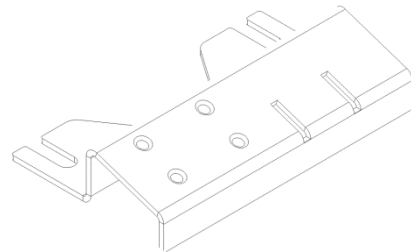
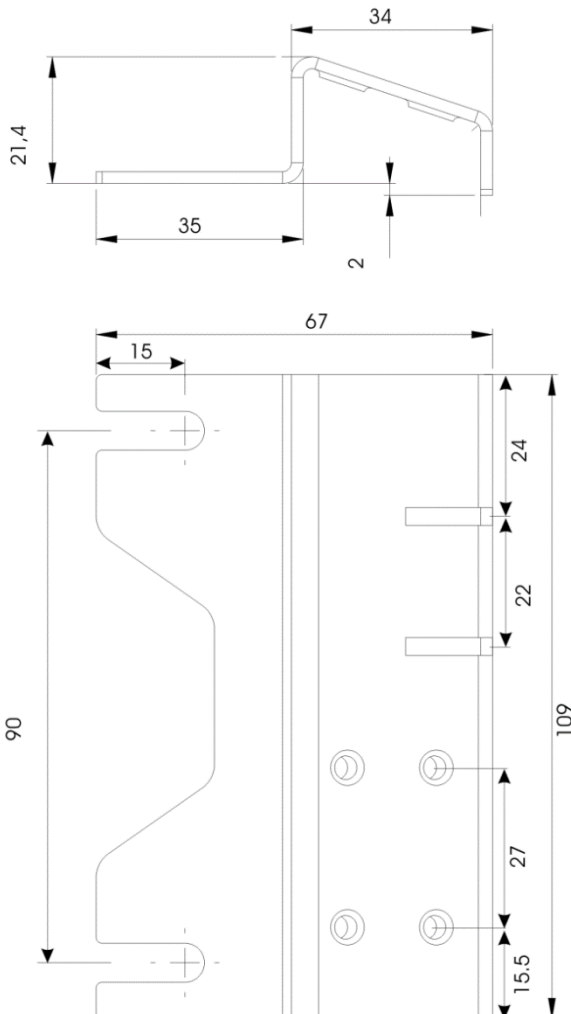

12.3 Brake resistor

The brake resistors convert the regenerative energy into heat when the drive is braking.

The resistor must be selected according to the duty cycle and braking power.

Mains voltage	Type	Resistor		Continu-ous power	Maximum permissible operating voltage	Integrated thermal protection
		Value	Rated power			
V		Ω	kW	W	V	
230	BR 160/100	100	1.6	160	900	Optional
230	BR 432/37	37	4.3	432	900	Optional
230	BR 667/24	24	6.6	667	900	Yes
230	BR 1332/12	12	13.3	1332	900	Yes
400	BR 213/300	300	2.1	213	900	Optional
400	BR 471/136	136	4.7	471	900	Optional
400	BR 696/92	92	6.9	696	900	Yes
400	BR 1330/48	48	13.3	1330	900	Yes
400	BR 2000/32	32	20	2000	900	Yes
400	BR 4000/16	16	40	4000	900	Yes
400	BR 8000/7	7.5	80	8000	900	Yes

12.3.1 230 V devices

The following table shows the cross reference of brake resistors, that can be used for a majority of applications.

The column "Percentage duty cycle" shows, how long inside a duty cycle the brake resistor can be operated with nominal power.

Frequency inverter			Recommended brake resistor	Power at percentage duty cycle, cycle time 120 s	
Type	1ph. kW	3ph. kW		Type	Percentage duty cycle % (1ph.)
KFU A2	0.09	0.18	BR 160/100	100	89
KFU A2	0.12	0.25	BR 160/100	100	64
KFU A2	0.18	0.37	BR 160/100	89	43
KFU A2	0.25	0.55	BR 160/100	64	29
KFU A2	0.37	0.75	BR 160/100	43	21
KFU A2	0.55	1.1	BR 160/100	29	15
KFU A2	0.75	1.5	BR 432/37	57	29
KFU A2	1.1	--	BR 432/37	39	--
	--	2.2	BR 432/37	--	20
KFU A2	1.5	3.0	BR 432/37	29	14
KFU A2	2.2	4.0	BR 432/37	20	11
KFU A2	3.0	5.5	BR 667/24	22	12
KFU A2	3.0	--	BR 667/24	22	--
	--	7.5	2x BR 432/37 ¹⁾	--	11

1) 2x BR432/37 parallel

For the connection of a brake resistor refer to chapter 5.6.5 "Brake resistor".

12.3.2 400 V devices

The following table shows the cross reference of brake resistors, that can be used for a majority of applications.

The column "Percentage duty cycle" shows, how long inside a duty cycle the brake resistor can be operated with nominal power.

Frequency inverter		Recommended brake resistor	Power at percentage duty cycle, cycle time 120 s
Type	kW	Type	Percentage duty cycle
		BR 213/300	%
KFU A4	0.25	BR 213/300	85
KFU A4	0.37	BR 213/300	58
KFU A4	0.55	BR 213/300	39
KFU A4	0.75	BR 213/300	28
KFU A4	1.1	BR 213/300	19
KFU A4	1.5	BR 213/300	14
KFU A4	2.2	BR 213/300	10
KFU A4	3.0	BR 471/136	16
KFU A4	4.0	BR 471/136	12
KFU A4	5.5	BR 471/136 ¹⁾	9
KFU A4	5.5	BR 1330/48	24
KFU A4	7.5	BR 1330/48	18
KFU A4	9.2	BR 1330/48	14
KFU A4	11	BR 1330/48	12

1) the maximum breaking power of this combination is limited to 4.4kW.

For the connection of a brake resistor refer to chapter 5.6.5 "Brake resistor".

12.4 Line choke

Line chokes reduce mains harmonics and reactive power.

The line choke must be installed between mains connection and input filter.

In chapter 11.2 "Device data" the devices, that require a line choke, are marked.

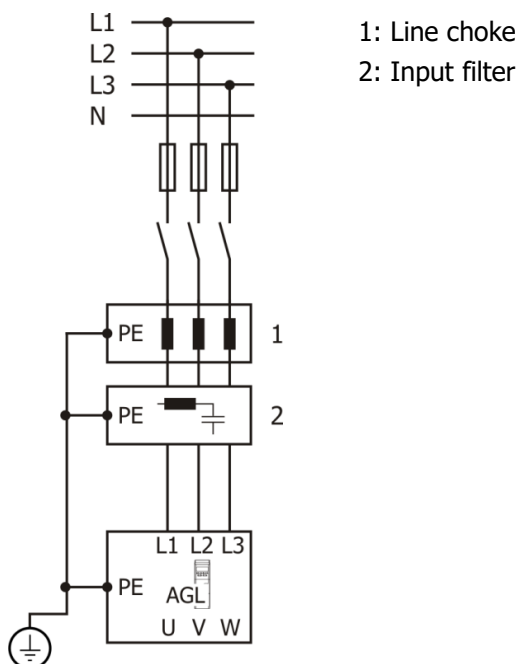

12.4.1 1x230 V connection

Frequency inverter 1phase operation		Recom- mended line choke	Rated cur- rent	Power dissipa- tion
Type		Type		
	kW		A	W
KFU A2	0.09	LCVS006	6	8
KFU A2	0.12			
KFU A2	0.18			
KFU A2	0.25			
KFU A2	0.37			
KFU A2	0.55			
KFU A2	0.75	LCVS008	8	8
KFU A2	1.1	LCVS015	15	12
KFU A2	1.5			
KFU A2	2.2	LCVS018 (*)	18	15
KFU A2	3.0		On request	
KFU A2	3.0		On request	

(*) Usage allowed using the maximum continuous line current of 18 A.

12.4.2 3x230 V connection

Frequency inverter 3phase operation		Recom- mended line choke Typ	Rated cur- rent A	Inductance mH	Power dissipa- tion W
Typ	kW				
KFU A2	0.18	LCVT004	4	7.32	20
KFU A2	0.25				
KFU A2	0.37				
KFU A2	0.55				
KFU A2	0.75				
KFU A2	1.1	LCVT006	6	4.88	25
KFU A2	1.5	LCVT008	8	3.66	30
KFU A2	2.2	LCVT010	10	2.93	30
KFU A2	3.0	LCVT015	15	1.95	45
KFU A2	4.0	LCVT018	18	1.63	70
KFU A2	5.5	LCVT025	25	1.17	70
KFU A2	7.5	LCVT034	34	0.86	85

12.4.3 3x400 V connection

Frequency inverter		Recom- mended line choke Typ	Rated cur- rent A	Inductance mH	Power dissipa- tion W
Typ	kW				
KFU A4	0.25	LCVT004	4	7.32	20
KFU A4	0.37				
KFU A4	0.55				
KFU A4	0.75				
KFU A4	1.1				
KFU A4	1.5				
KFU A4	2.2	LCVT006	6	4.88	25
KFU A4	3.0	LCVT008	8	3.66	30
KFU A4	4.0	LCVT010	10	2.93	30
KFU A4	5.5	LCVT015	15	1.95	45
KFU A4	5.5	LCVT015	15	1.95	45
KFU A4	7.5	LCVT018	18	1.63	70
KFU A4	9.2	LCVT025	25	1.17	70
KFU A4	11	LCVT034	34	0.86	85

12.4.4 Dimensions

LCVS006 ... LCVS018

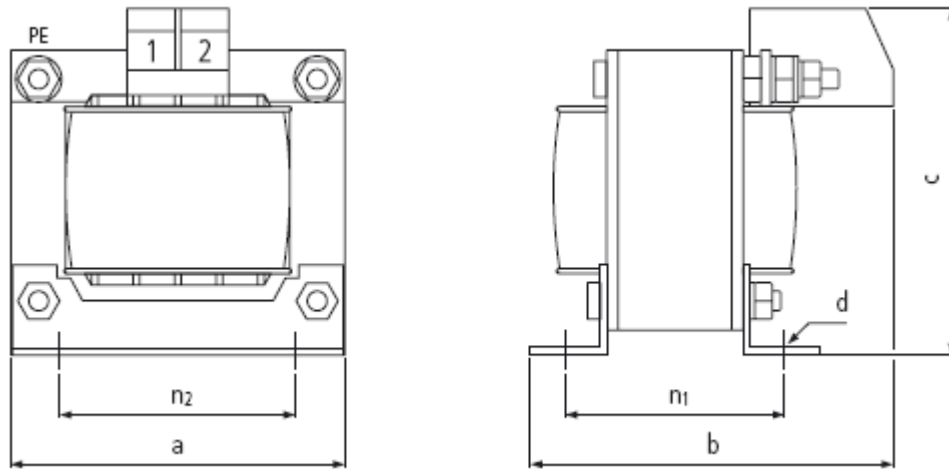

Type	Dimensions			Assembly			Weight	Connection		
	a mm	b mm	c mm	n ₂ mm	n ₁ mm	d mm		mm	Nm	PE
LCVS006	60	62	75	44	38	3.6	0.5	0.75 ... 2.5	1.0 ... 1.2	2.5 mm ²
LCVS008	60	67	75	44	43	3.6	0.6	0.75 ... 2.5	1.0 ... 1.2	2.5 mm ²
LCVS010	66	80	70	50	51	4.8	0.8	0.75 ... 2.5	1.0 ... 1.2	M4
LCVS015	78	78	80	56	49	4.8	1.1	0.75 ... 4.0	1.5 ... 1.8	M4
LCVS018	85	85	95	64	50	4.8	1.8	0.75 ... 4.0	1.5 ... 1.8	M4

LCVT004 ..LCVT025

LCVT034

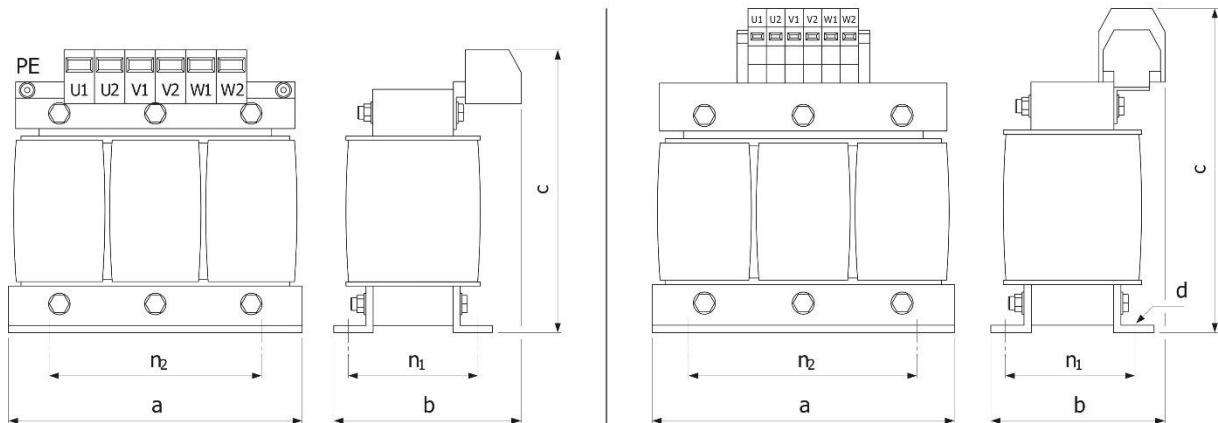

Type	Dimensions			Assembly			Weight	Connection		
	a mm	b mm	c mm	n ₂ mm	n ₁ mm	d mm		mm	Nm	PE
LCVT004	80	65	95	55	37	4	0.8	0.75 ... 2.5	1.0 ... 1.2	4 mm ²
LCVT006	100	65	115	60	39	4	1.0	0.75 ... 2.5	1.0 ... 1.2	4 mm ²
LCVT008	100	75	115	60	48	4	1.5	0.75 ... 2.5	1.0 ... 1.2	4 mm ²
LCVT010	100	75	115	60	48	4	1.5	0.75 ... 2.5	1.0 ... 1.2	4 mm ²
LCVT015	125	85	135	100	55	5	3.0	0.75 ... 4.0	1.5 ... 1.8	4 mm ²
LCVT018	155	90	135	130	57	8	4.0	0.75 ... 4.0	1.5 ... 1.8	4 mm ²
LCVT025	155	100	160	130	57	8	4.0	0.75 ... 10	4.0 ... 4.5	4 mm ²
LCVT034	155	100	190	130	57	8	4.5	2.5 ... 16	2.0 ... 4.0	M5

12.5 Input filter

Input filters damp the conducted radio-frequency interference voltage. The filter must be installed upstream on mains input side of the frequency inverter.

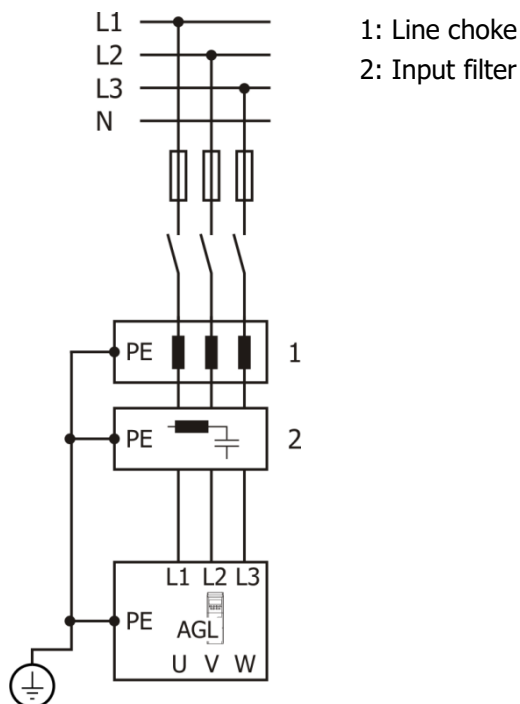

Circuit diagram of input filter (schematic)

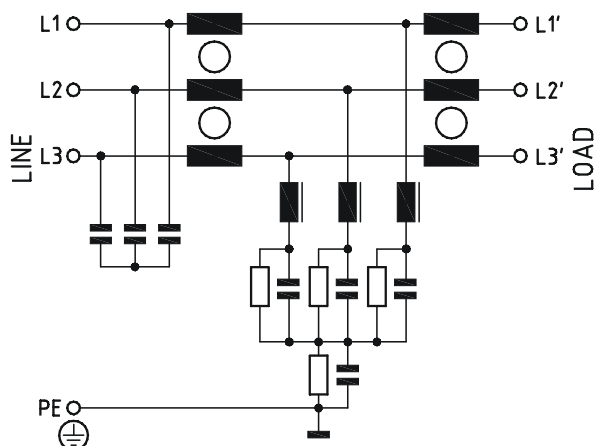

12.5.1 Footprint filter

The filter can be installed below the frequency inverter or next to the frequency inverter onto the mounting plate.

Frequency inverter KFU 402		Recommended Filter	
kW	Size	Type (Order code)	Product Code (Type Plate)
0.25 ... 2.2	1	FTV001B-AGL	FS28364-8-07
3.0 ... 4.0	2	FTV002B-AGL	FS28364-10-07
5.5 ... 11.0	3	FTV003B-AGL	FS28364-26-07

KFU A2- / A4-

Filter	Rated current	Rated voltage	Operating frequency	Operational leakage current	Operational temperature range	Weight
Type	A	V	Hz	mA	°C	kg
FTV001B-AGL	8	3x480/275	50/60 Hz	3.5	-25 ... 100	0.9
FTV002B-AGL	10	3x480/275	50/60 Hz	3.5	-25 ... 100	1.1
FTV003B-AGL	26	3x480/275	50/60 Hz	3.5	-25 ... 100	1.7

Safety terminal block: Flex wire AWG 10, Flex wire 4 mm², Solid wire 6 mm²

Dimensions

FTV001B-AGL

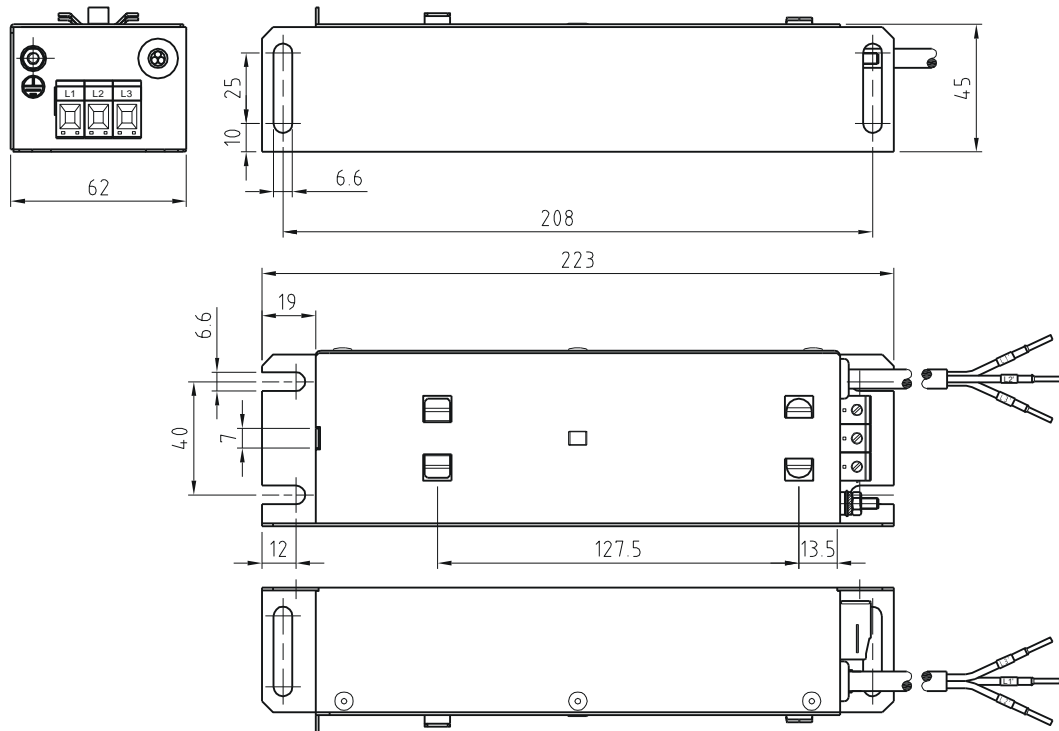

FTV002B-AGL

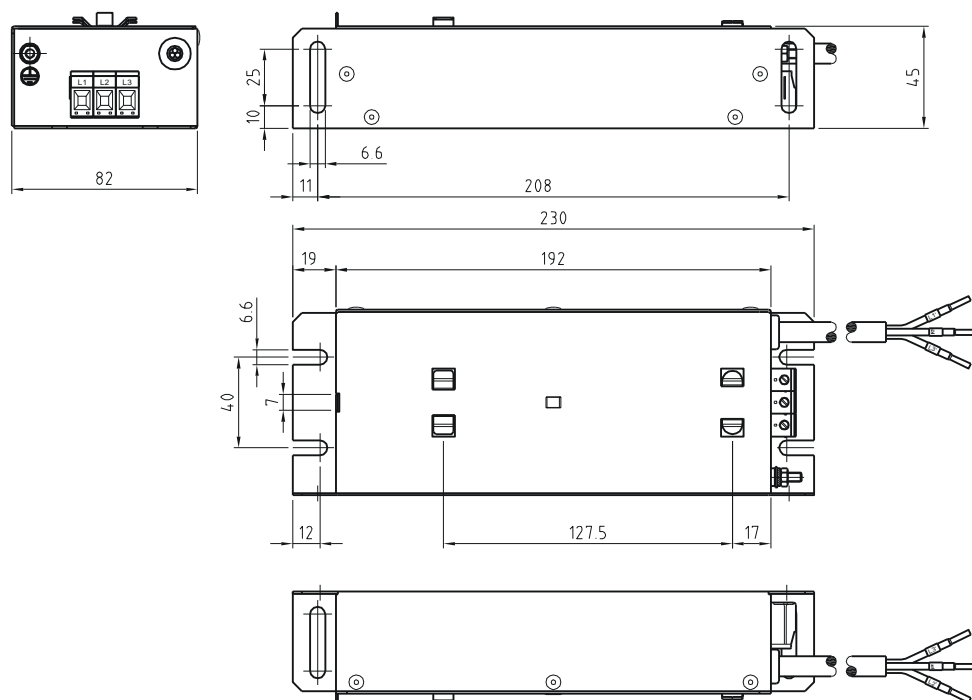

FTV003B-AGL

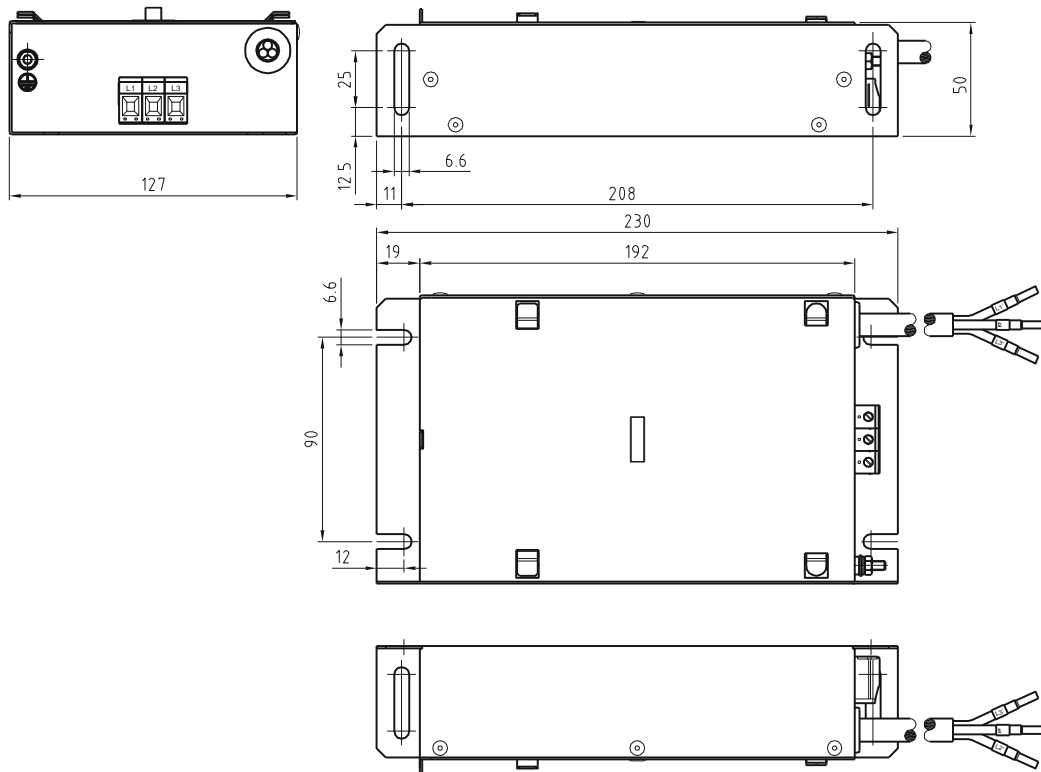

12.5.2 Booktype filter

The filter can be installed next to the frequency inverter onto the mounting plate. The connection terminal consists of a safety terminal block.

Frequency inverter		Recommended filter
kW	Size	Type
0.25 ... 2.2	1	FTV007A
3.0 ... 4.0	2	FTV016A
5.5 ... 7.5	3	FTV016A
9.2 ... 11.0	3	FTV030A

Filter	Rated current	Rated voltage	Operating frequency	Operational leakage current	Operational temperature range	Power loss ¹⁾	Weight
Type	A	V	Hz	mA	°C	W	kg
FTV007A	7	3x480	50/60 Hz	33	-25 ... 100	3.8	0.5
FTV016A	16	3x480	50/60 Hz	33	-25 ... 100	6.1	0.8
FTV030A	30	3x480	50/60 Hz	33	-25 ... 100	11.8	1.2

¹⁾ At 25 °C, 50 Hz.

Dimensions

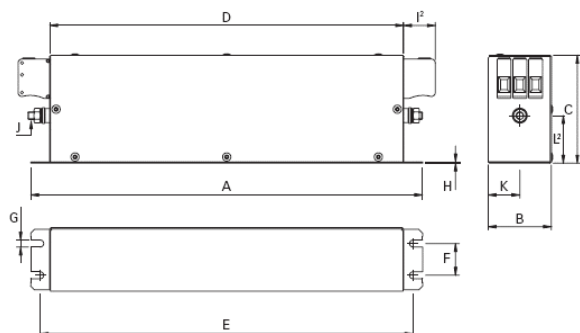

	A	B	C	D	E	F	G	H	I ¹	I ²	J	K	L ¹	L ²
FTV007A	190	40	70	160	180	20	4.5	1	10.6	22	M5	20	31	29.5
FTV016A	250	45	70	220	235	25	5.4	1	10.6	22	M5	22.5	31	29.5
FTV030A	270	50	85	240	255	30	5.4	1	12.6	25	M5	25	40	39.5

Filter input/output connector cross sections

	-33	-44
Solid wire	16 mm ²	10 mm ²
Flex wire	10 mm ²	6 mm ²
AWG type wire	AWG 6	AWG 8
Recommended torque	1.5 – 1.8 Nm	1.5 – 1.8 Nm

12.5.3 Interference suppression class

The emitted interference of the KFU devices was measured with typical setups. With the complied limit values, the KFU devices can be used with shielded motor cables in industrial and residential environments. Using main chokes or filters reduce the emitted interference of the devices.

12.5.3.1 AC 3x400 V

Interference suppression class *KFU* size 1

Installation measure	KFU 1
Without EMC input filter, without line choke	Class C3
Without EMC input filter, with line choke	Class C3
With footprint filter FS28364-8-07	Class C1
With footprint filter FS28364-8-07 and line choke upstream on mains input side	Class C1
With booktype filter FTV007A	Class C1
With booktype filter FTV007A and line choke upstream on mains input side	Class C1

Interference suppression class *KFU* size 2

Installation measure	KFU 2
Without EMC input filter, without line choke	Class C3
Without EMC input filter, with line choke 10 A	Class C3
With footprint filter FS28364-10-44	Class C1
With footprint filter FS28364-10-44 and line choke 10 A upstream on mains input side	Class C1
With booktype filter FTV016A	Class C1
With booktype filter FTV016A and line choke 10 A upstream on mains input side	Class C1

Interference suppression class *KFU* size 3, KFU A4-19 (5.5 kW), KFU A4-21 (7.5 kW)

Installation measure	KFU 3 KFU A4-19 (5.5 kW) KFU A4-21 (7.5 kW)
Without EMC input filter, without line choke	Class C3
Without EMC input filter, with line choke 15 A or 25 A	Class C3
With footprint filter FTV003B-AGL	Class C1
With footprint filter FTV003B-AGL and line choke 25 A upstream on mains input side	Class C1
With booktype filter FTV016A	Class C1
With booktype filter FTV016A and line choke 15 A upstream on mains input side	Class C1

Interference suppression class *KFU* size 3, KFU A4-22 (9.2 kW)

Installation measure	KFU 3 KFU A4-22 (9.2 kW)
Without EMC input filter, without line choke	Class C3
Without EMC input filter, with line choke 15 A or 25 A	Class C3
With footprint filter FTV003B-AGL	Class C1
With footprint filter FTV003B-AGL and line choke 25 A upstream on mains input side	Class C1
With booktype filter FTV016A	Class C1
With booktype filter FTV016A und Netzdrossel vor dem Filter	Class C1

Interference suppression class *KFU* size 3, KFU A4-23 (11 kW)

Installation measure	KFU 3 KFU A4-23 (11 kW)
Without EMC input filter, without line choke	Class C3
Without EMC input filter, with line choke 15 A or 25 A	Class C3
With footprint filter FTV003B-AGL	Class C1
With footprint filter FTV003B-AGL and line choke 25 A upstream on mains input side	Class C1
With booktype filter FTV030A	Class C1
With booktype filter FTV030A and line choke 25 A upstream on mains input side	Class C1

12.5.3.2 AC 3x230 V

Interference suppression class *KFU* size 1

Installation measure	KFU 1
Without EMC input filter, without line choke	Class C3
Without EMC input filter, with line choke	Class C3
With footprint filter FS28364-8-07	Class C1
With footprint filter FS28364-8-07 and line choke upstream on mains input side	Class C1
With booktype filter FTV007A	Class C1
With booktype filter FTV007A and line choke upstream on mains input side	Class C1

Interference suppression class *KFU* size 2

Installation measure	KFU 2
Without EMC input filter, without line choke	Class C3
Without EMC input filter, with line choke 10 A	On request
With footprint filter FS28364-10-44	
With footprint filter FS28364-10-44 and line choke 10 A upstream on mains input side	
With booktype filter FTV016A	
With booktype filter FTV016A and line choke 10 A upstream on mains input side	

Interference suppression class *KFU* size 3, KFU A2-19 (5.5 kW), KFU A2-21 (7.5 kW)

Installation measure	KFU 3 KFU A2-19 (5.5 kW) KFU A2-21 (7.5 kW)
Without EMC input filter, without line choke	-
Without EMC input filter, with line choke 15 A or 25 A	Class C3
With footprint filter FTV003B-AGL	Class C1
With footprint filter FTV003B-AGL and line choke 25 A upstream on mains input side	Class C1
With booktype filter FTV016A	Class C1
With booktype filter FTV016A and line choke 15 A upstream on mains input side	Class C1

12.5.3.3 AC 1x230 V

Interference suppression class *KFU* size 1

Installation measure	KFU 1
Without EMC input filter, without line choke	Class C3
Without EMC input filter, with line choke	On request
With footprint filter FS28364-8-07	
With footprint filter FS28364-8-07 and line choke upstream on mains input side	
With booktype filter FTV007A	
With booktype filter FTV007A and line choke upstream on mains input side	

Interference suppression class *KFU* size 2

Installation measure	KFU 2
Without EMC input filter, without line choke	Class C3
Without EMC input filter, with line choke	On request
With footprint filter	
With footprint filter and line choke upstream on mains input side	
With booktype filter	
With booktype filter and line choke upstream on mains input side	

Interference suppression class *KFU* size 3, KFU A2-19 (3.50kW), KFU A2-21 (3.0 kW)

Installation measure	KFU 3 KFU A2-19 (3.0 kW) KFU A2-21 (3.0 kW)
Without EMC input filter, without line choke	Class C3
Without EMC input filter, with line choke 15 A or 25 A	On request
With footprint filter	
With footprint filter and line choke upstream on mains input side	
With booktype filter	
With booktype filter and line choke upstream on mains input side	

12.6 Communication module

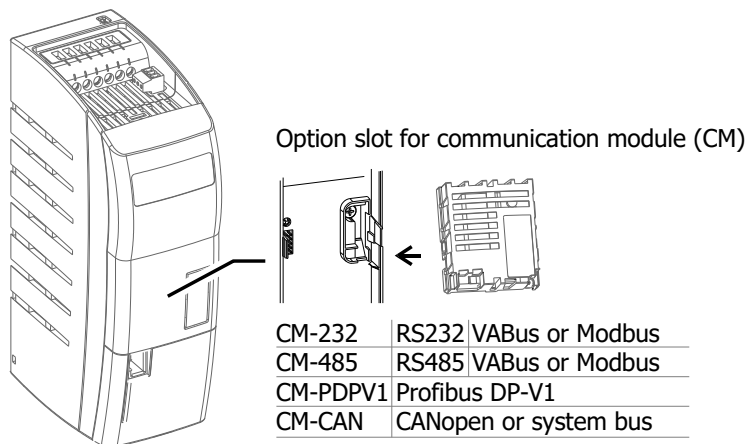

Further communications modules are listed in chapter 3.1 "Inverter type and warning signs on the device". The VABus protocol is used for communication with the PC software VPlus for parameter settings, monitoring and diagnosis.

Installation and commissioning of a communication module are described in the separate instruction manuals of the communication protocols.

12.7 USB adaptor

Via an optional USB adaptor the communication interface X21 can be connected to the USB interface of a PC. It enables parameter settings, monitoring and diagnosis via PC software VPlus.

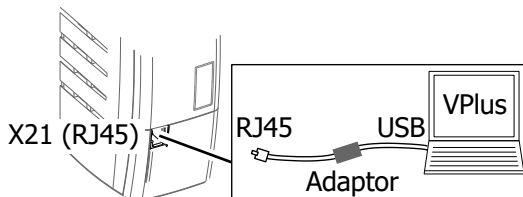

12.8 Resource pack

The frequency inverter can be extended by an optional resource pack (memory card).

Resource pack

- Capacity = 2 GB
- SPI protocol
- Parameter copy function
- Integrated documentation

Parameter values of a frequency inverter can be saved on standard digital memory cards and uploaded on another frequency inverter. Refer to chapter 7.10.11 "Copy parameters".

NOTE:

To use the copy function, use the Resource pack offered by KÜENLE ANTRIEBSSYSTEME.

KÜENLE ANTRIEBSSYSTEME doesn't take any responsibility for the malfunctioning of the memory cards of other manufacturers.

12.9 Assembly variants

Assembly variants of the *KFU* device series:

- Standard (included in the scope of supply, see chapter 4.2 "Installation")
- Feed-through (This assembly set is not included in delivery.)
- Cold Plate (This assembly set is not included in delivery.)
- Vibration-proof (This assembly set is not included in delivery.)
- DIN rail for size 1 (This assembly set is not included in delivery.)

Feed-through

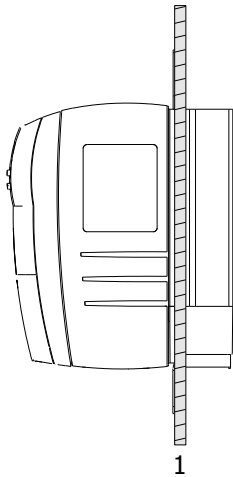

Cold Plate

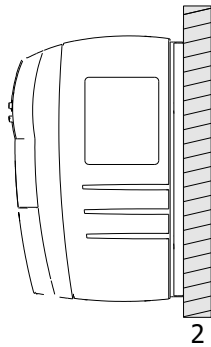

Vibration-proof

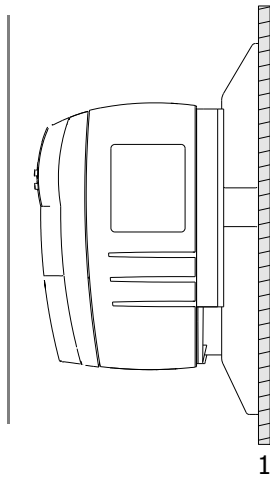

DIN rail

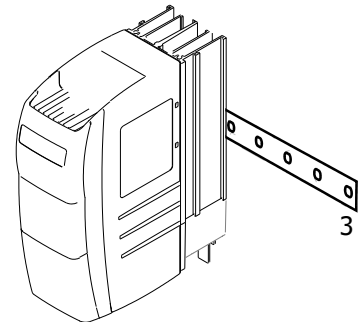

- 1: Mounting plate
2: Mounting plate as external heat sink
3: DIN rail

12.9.1 Feed-through assembly (This assembly set is not included in delivery.)

The feed-through assembly facilitates the thermal separation.

The heat sink of the frequency inverter can be fed through the mounting plate. The power dissipation can be passed on to an external cooling cycle.

12.9.1.1 Cooling air flow rate required and energy dissipation

KFU A2- / A4-

The required cooling air flow rate and the device-specific energy dissipation P_d of the heat sink are listed in the following table. Additionally, the thermal radiation (energy dissipation, interior) of the frequency inverter is indicated.

Type											
KFU 202 / 402			-01	-02	-03	-05	-07	-09	-11	-13	
Size			1								
Cooling air											
Cooling air flow rate, required		m ³ /h	-	-	-	-	-	-	30	30	
Influencing factors											
Energy dissipation, heat sink [2 kHz]		P_d	W	12	19	29	42	53	70	89	122
Energy dissipation, interior		$P_{d \text{ interior}}$	W	10	10	11	12	15	18	21	25

Type										
KFU 402			-15	-18	-19	-19	-21	-22	-23	
Size			2				3			
Cooling air										
Cooling air flow rate, required		m ³ /h	60	60	100	100	100	100	100	100
Influencing factors										
Energy dissipation, heat sink [2 kHz]		P_d	W	133	167	230	235	321	393	470
Energy dissipation, interior		$P_{d \text{ interior}}$	W	31	35	45	48	61	68	81

Separation of energy dissipation:

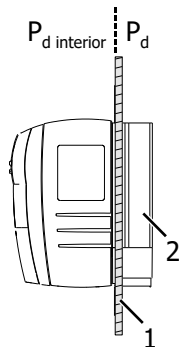

- $P_{d \text{ interior}}$ Energy dissipation, interior
- P_d Energy dissipation, heat sink
- 1 Mounting plate
- 2 Heat sink

12.9.1.2 Size 1 (3~: 0.18 kW to 2.2 kW; 1~: 0.09 kW to 1.1 kW)

KFU A2- / A4-

Frequency inverter			
Type	KFU A2		KFU A4
Mains supply	1ph.	3ph.	3ph.
Power	kW	kW	kW
	0.09	0.18	--
	0.12	0.25	0.25
	0.18	0.37	0.37
	0.25	0.55	0.55

Frequency inverter			
Type	KFU 202		KFU 402
Mains supply	1ph.	3ph.	3ph.
Power	kW	kW	kW
-07 1	0.37	0.75	0.75
-09 1	0.55	1.1	1.1
-11 1	0.75	1.5	1.5
-13 1	1.1	2.2	2.2

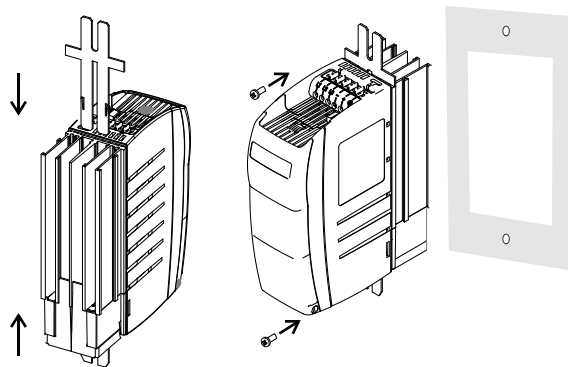
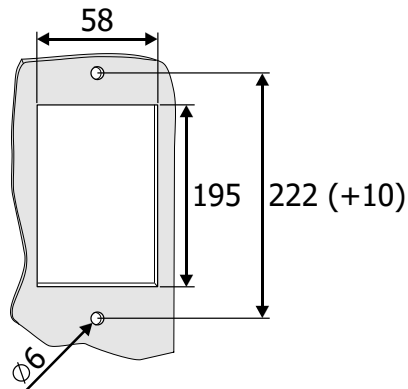
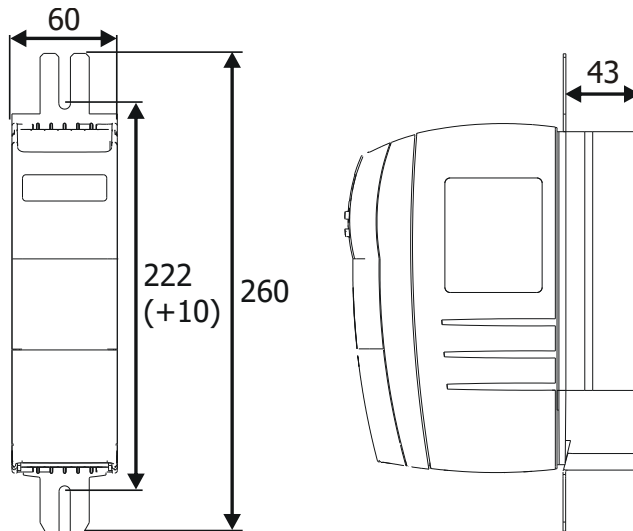

Place a seal between frequency inverter and mounting plate.
Use screws M6 with minimum length 30 mm.

12.9.1.3 Size 2 (3~: 3.0 kW to 5.5 kW; 1~: 1.5 kW to 2.2 kW)

Frequency inverter			
Type	KFU A2		KFU A4
Mains supply	1ph.	3ph.	3ph.
Power	kW	kW	kW
	1.5	3.0	3.0
	2.2	4.0	4.0
	--	--	5.5

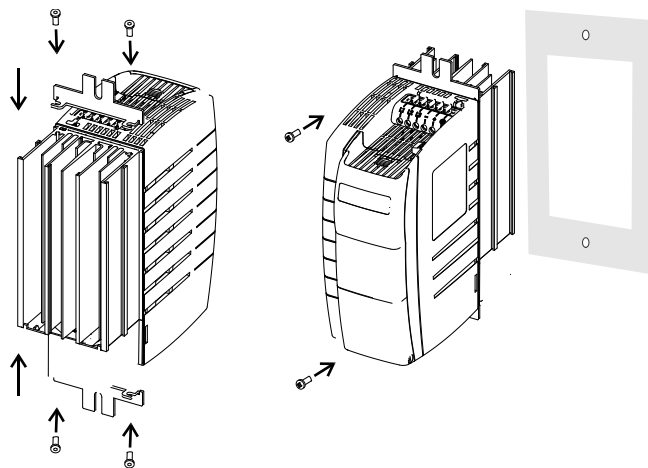
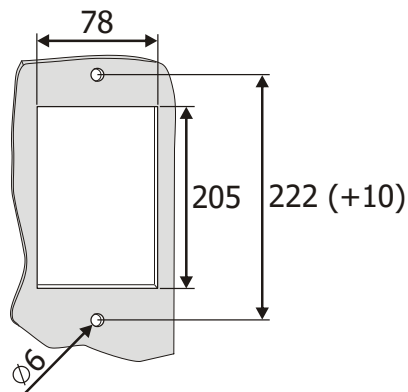
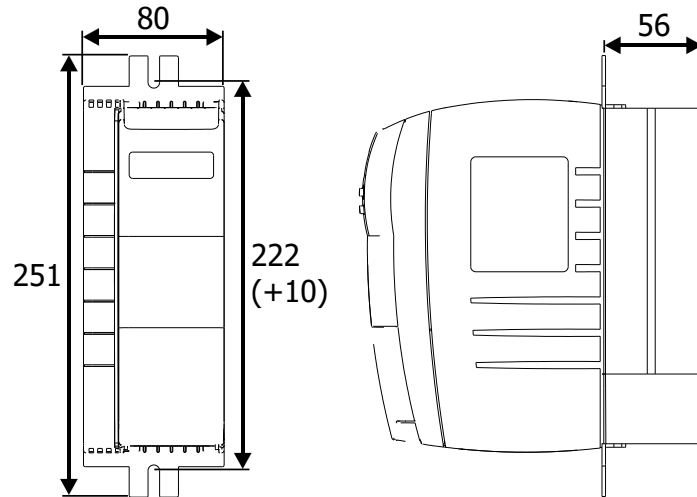

Place a seal between frequency inverter and mounting plate.
Use screws M6 with minimum length 30 mm.

12.9.1.4 Size 3 (5.5 kW to 11.0 kW)

12.9.1.4.1 With heat sink fan

Valid for the following devices

Frequency inverter			
Type	KFU A2		KFU A4
Mains supply	1ph.	3ph.	3ph.
Power	kW	kW	kW
	3	5.5	5.5
	3	7.5	7.5

Frequency inverter			
Type	KFU A2		KFU A4
Mains supply	1ph.	3ph.	3ph.
Power	kW	kW	kW
	--	--	9.2
	--	--	11

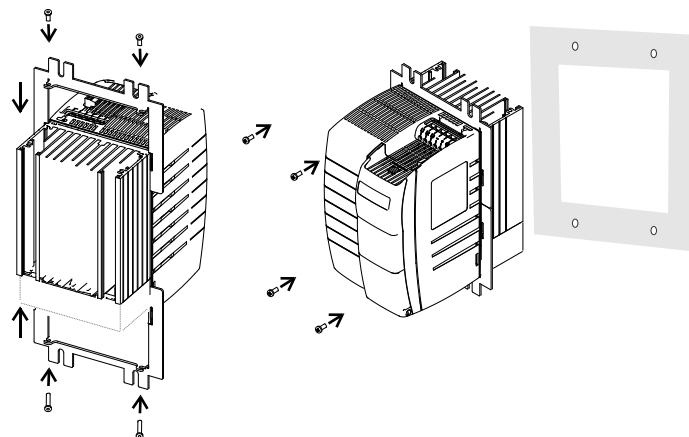
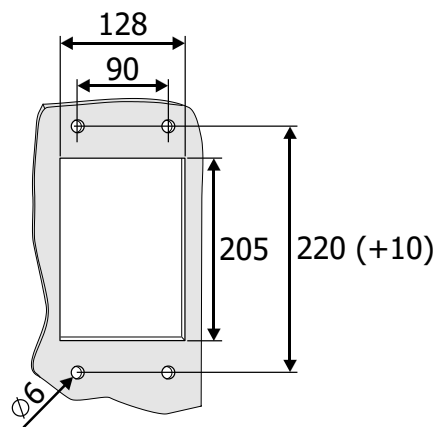
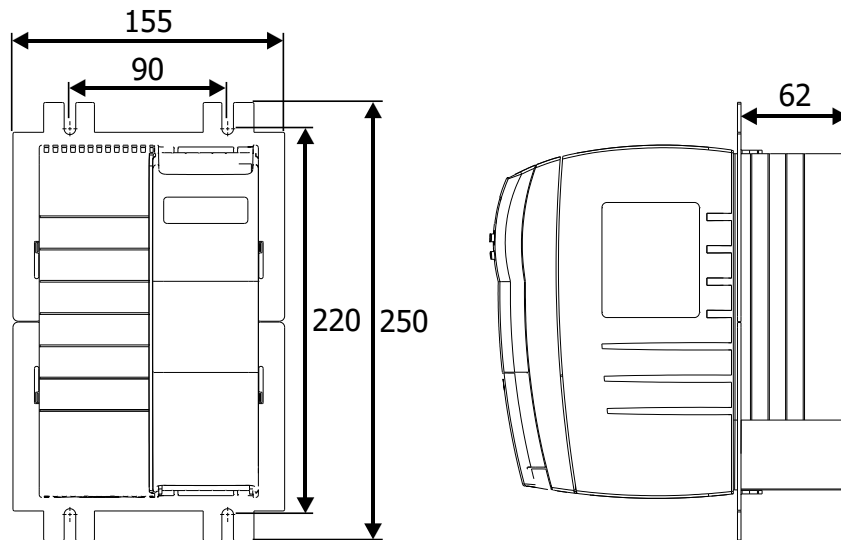

Place a seal between frequency inverter and mounting plate.

Use screws M6 with minimum length 30 mm.

12.9.1.4.2 Without heat sink fan

Valid for the following devices

Frequency inverter			
Type	KFU A2		KFU A4
Mains supply	1ph.	3ph.	3ph.
Power	kW	kW	kW
	3	5.5	5.5
	3	7.5	7.5

Frequency inverter			
Type	KFU A2		KFU A4
Mains supply	1ph.	3ph.	3ph.
Power	kW	kW	kW
	--	--	9.2
	--	--	11

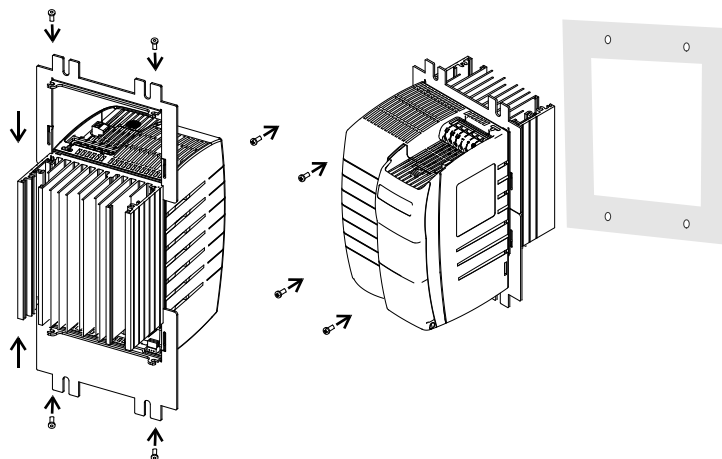
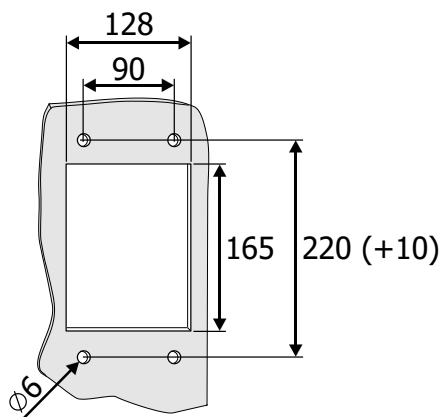
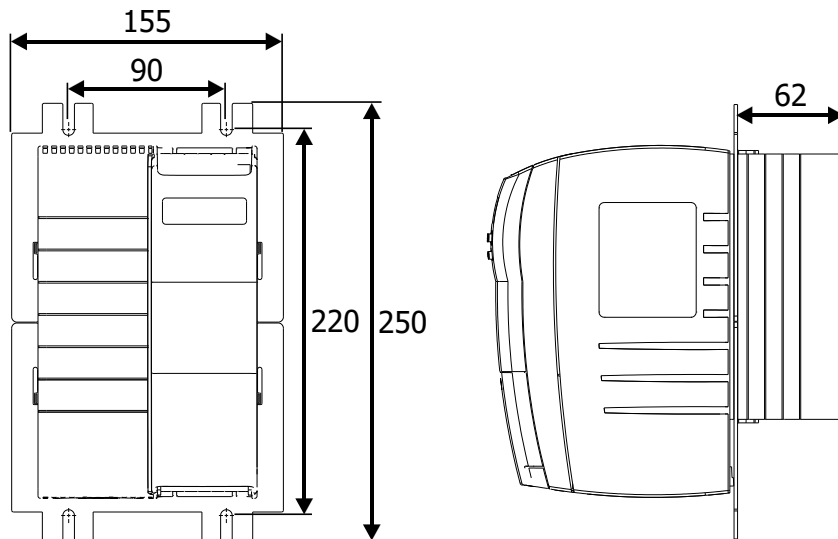

Place a seal between frequency inverter and mounting plate.
Use screws M6 with minimum length 30 mm.

12.9.2 Cold Plate (This assembly set is not included in delivery.)

The "Cold Plate" variant enables installation of the frequency inverter on suitable surfaces which have sufficient thermal conductivity to dissipate the heat developing during the operation of the frequency inverter.

Cooling is realized by means of a sufficient cooling area of the mounting plate or via an additional cooler.

12.9.2.1 Range of application

The "Cold Plate" variant enables the use of the frequency inverter in the following applications:

- Installation in a housing, where a high type of protection is required but the volume of the housing limits thermal compensation.
- Use in highly polluted cooling air affecting the function and service life of the fan.
- Use of several frequency inverters in limited space conditions, e.g. installation of frequency inverters on a liquid-cooled plate (sum cooler).
- Direct assembly on (or in) a machine case, with parts of the machine constructions taking over the cooling function.

12.9.2.2 Required thermal properties of the external heat sink

The heat in the frequency inverter due to the energy dissipation of the electronic components (rectifier and IGBT) must be dissipated to a heat sink via the cold plate of the frequency inverter.

The capacity to dissipate this heat mainly depends on

- the size of the heat sink surface,
- the ambient temperature and
- the heat transmission resistance.

An increase of the heat transmission rate can only be realized to a certain extent by increasing the surface of the heat sink. An additional increase of the heat dissipation by increasing the heat sink is not possible.

The frequency inverter must be mounted with the cold plate on an external heat sink with the lowest thermal resistance possible.

Thermal resistance

The thermal resistance R_{th} is calculated from the difference between the maximum heat sink temperature and the ambient temperature, referred to the energy dissipation of the frequency inverter. The ambient temperature to be considered refers to the immediate environment of the frequency inverter.

$$R_{th} = \frac{T_{h\ max} - T_a}{P_d}$$

Max. permissible heat sink temperature of the frequency inverter	$T_{h\ max} = 75\ ^\circ\text{C}$
Ambient temperature of the heat sink	$T_a = 35\ ^\circ\text{C}$
Difference between the maximum heat sink temperature and the ambient temperature ($T_{h\ max} - T_a$)	$\Delta T = 40\ \text{K}$
Energy to be dissipated by the heat sink	P_d : device-specific

KFU A2- / A4-

The following tables list the maximum permissible thermal resistance R_{th} of the external heat sink and the device-specific energy dissipation P_d of the external heat sink. The thermal resistance R_{th} is given in the unit Kelvin per Watt (K/W). The value of R_{th} can typically be taken from the data sheet of the external heat sink. Additionally, the thermal radiation (energy dissipation, interior) of the frequency inverter is indicated in the table.

Type										
KFU 402/ KFU 202			-01	-02	-03	-05	-07	-09	-11	-13
Size			1							
Influencing factors										
Energy dissipation, heat sink [2 kHz]	P_d	W	12	19	29	42	53	70	89	122
Energy dissipation, interior	$P_{d \text{ interior}}$	W	10	10	11	12	15	18	21	25
Thermal resistance										
$T_{h \text{ max}} - T_a$	ΔT	K	40							
Thermal resistance	R_{th}	K/W	3.33	2.11	1.38	0.95	0.75	0.57	0.45	0.33
Mechanics										
Cooling surface of Cold Plate	H x B	mm	190 x 83							
Weight (approx.)	m	kg	1.1							

Type										
KFU 402/ KFU 202			-15	-18	-19	-19	-21	-22	-23	
Size			2				3			
Influencing factors										
Energy dissipation, heat sink [2 kHz]	P_d	W	133	167		235	321	393	470	
Energy dissipation, interior	$P_{d \text{ interior}}$	W	31	35		48	61	68	81	
Thermal resistance										
$T_{h \text{ max}} - T_a$	ΔT	K	40							
Thermal resistance	R_{th}	K/W	0.30	0.24	0.17	0.17	0.12	0.10	0.09	
Mechanics										
Cooling surface of Cold Plate	H x B	mm	190 x 103				190 x 148			
Weight (approx.)	m	kg	1.35				2.6			

The thermal resistance values and the technical data apply in the following conditions:

- No airflow.
- Clearance of approx. 300 mm above and below as well as 100 mm on both the left and right side of the frequency inverter.

The energy dissipation values are also valid for the switching frequencies of 4, 8, 12 and 16 kHz, as at these operating points, the output current is reduced.

Separation of energy dissipation:

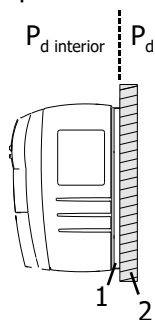

- $P_{d \text{ interior}}$ Energy dissipation, interior
- P_d Energy dissipation, heat sink
- 1 Cold Plate of frequency inverter
- 2 Mounting plate as external heat sink

12.9.2.3 Additional fan or liquid cooling

The size of the heat sink can be reduced if fans are installed or a liquid cooling system is used in addition to the "Cold Plate" assembly.

The size of the external heat sink can be reduced proportionally to the increase in the flow rate of the cooling medium.

In the following a fan cooling system is described as an example. For calculating the maximum permissible heat resistance $R_{th\ enforced}$ for cooling by means of a fan, a proportionality factor is introduced. This factor describes the increase of the maximum permissible thermal resistance at increasing flow rate of the cooling air.

The maximum permissible thermal resistance $R_{th\ enforced}$ for enforced air cooling can be calculated as follows:

$$R_{th\ enforced} = \frac{R_{th}}{\alpha}$$

R_{th} : Maximum permissible thermal resistance with free circulation of air. Calculate according to the formula for R_{th} in the previous chapter or use the value indicated in the table.

α : Proportionality factor.

The relation is shown, as an example, in the following table for the *KFU* 402-23 frequency inverter.

Thermal resistance for enforced air cooling			
R_{th} [K/W]	V_{air} [m/s]	α	$R_{th\ enforced}$ [K/W]
0.09	0	1	0.09
0.09	1	0.65	0.14
0.09	2	0.45	0.20
0.09	4	0.28	0.32
0.09	6	0.20	0.45

12.9.2.4 Application notes

- Comply with the operation diagrams for power reductions (derating).
- Comply with the thermal limiting values of the frequency inverter. Refer to chapter 11 "Technical data" and 12.9.2.4.1 "Temperature monitoring".
- Additional power losses $P_{d\ interior}$ are dissipated as heat into the interior of a control cabinet. These losses may amount to 30% of the total energy dissipation and must be considered in the calculation of the volume of the control cabinet. The values are listed in the tables in chapter 12.9.2.2 "Required thermal properties of the external heat sink".
- If several frequency inverters or other heat-producing devices are mounted on a common heat sink (sum cooler), the losses of all devices must be added up. Calculate the maximum permissible thermal resistance R_{th} using the formula (chapter 12.9.2.2 "Required thermal properties of the external heat sink").
- The contact surface of the external heat sink must have a sufficient thermal conductivity.

12.9.2.4.1 Temperature monitoring

The heat sink temperature and the interior temperature can be monitored:

- The temperatures can be displayed in the actual value menu. Refer to chapter 9.1 "Actual values of frequency inverter".
- When the maximum permitted temperatures are reached error-switch-off is effected and an error message is triggered.
- Before the maximum permitted temperatures are reached a warning message is triggered. An error-switch-off can be avoided. The temperature values for the warnings can be set via parameter. Refer to chapter 7.4.2 "Temperature".

Error-switch-off is effected at:

- Maximum heat sink temperature
- Maximum interior temperature

In the factory setting a warning message is triggered when

- the maximum heat sink temperature is reached (minus 5 °C)
- the maximum interior temperature is reached (minus 5 °C)

The warning messages can be output via digital outputs.

12.9.2.5 Assembly

12.9.2.5.1 Safety



WARNING

To avoid serious physical injury or considerable damage to property, only qualified staff may work on the devices.

During operation, the heat sink can reach a temperature of up to 75 °C. Do not touch the heat sink during operation.

The heat sink may be hot even some time after the frequency inverter was switched off.

Comply with the following requirements:

- The installation surface of the external heat sink must at least be as large as the cold plate surface.
 - The contact surfaces of the external heat sink and cold plate must be plane.
 - The contact surfaces must be clean and degreased.
- For fixing the frequency inverter, drill 6 threaded holes M6 in the installation surface. For the installation dimensions, refer to the following chapters.
 - Deburr the threaded holes.
 - Clean the contact surfaces of the external heat sink and cold plate.
 - Apply a thin and uniform film of heat conducting paste on the cold plate.



The heat conducting paste compensates the roughness of the contact surfaces and thus the heat transmission resistance between the cold plate and the heat sink. In this way, the cooling efficiency is increased.

- Mount the frequency inverter vertically on the heat sink using six M6 bolts. The bolts must have a minimum length of 30 mm. Tighten all bolts uniformly.



The maximum tightening torque of the fixing bolts in a typical construction is 3.4 Nm.

After the mechanical installation continue with the electrical installation according to chapter 5 "Electrical Installation". Comply with the safety instructions provided there.

12.9.2.5.2 Size 1 (3~: 0.18 kW to 2.2 kW; 1~: 0.09 kW to 1.1 kW)

Frequency inverter			
Type	KFU A2		KFU A4
Mains supply	1ph.	3ph.	3ph.
Power	kW	kW	kW
	0.09	0.18	0.18
	0.12	0.25	0.25
	0.18	0.37	0.37
	0.25	0.55	0.55
	0.37	0.75	0.75
	0.55	1.1	1.1
	0.75	1.5	1.5
	1.1	2.2	2.2

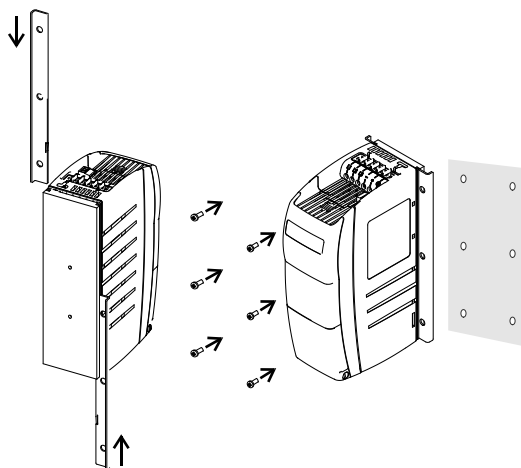
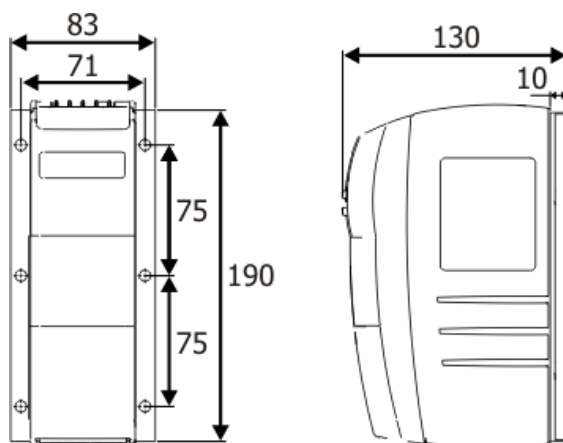

12.9.2.5.3 Size 2 (3.0 kW to 5.5 kW)

Frequency inverter			
Type	KFU A2		KFU A4
Mains supply	1ph.	3ph.	3ph.
Power	kW	kW	kW
	1.5	3.0	3.0
	2.2	4.0	4.0
	--	--	5.5

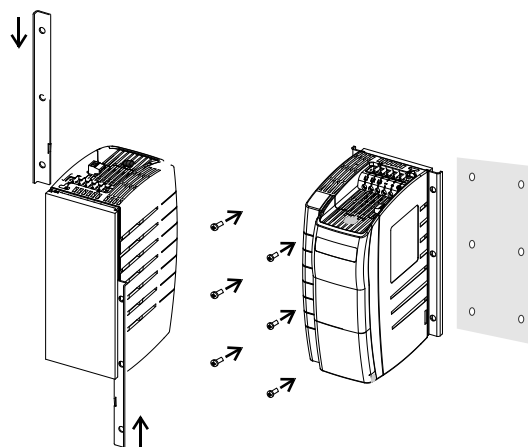
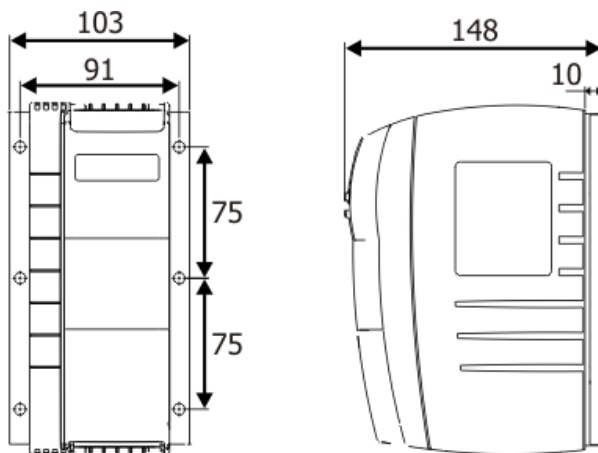

12.9.2.5.4 Size 3 (5.5 kW to 11.0 kW)

Frequency inverter			
Type	KFU A2		KFU A4
Mains supply	1ph.	3ph.	3ph.
Power	kW	kW	kW
	3	5.5	5.5
	3	7.5	7.5
	--	--	9.2
	--	--	11

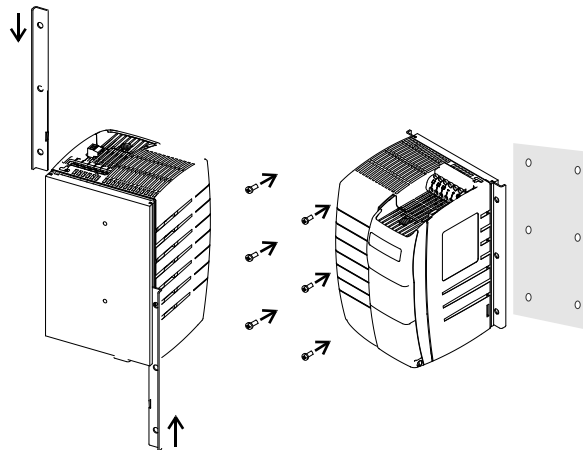
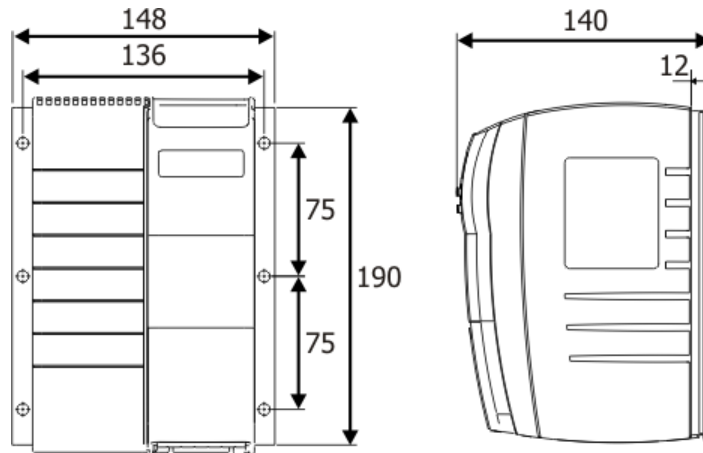

12.9.3 Vibration-proof (This assembly set is not included in delivery.)

12.9.3.1 Size 1 (3~: 0.18 kW to 2.2 kW; 1~: 0.09 kW to 1.1 kW)

Frequency inverter			
Type	KFU A2		KFU A4
Mains supply	1ph.	3ph.	3ph.
Power	kW	kW	kW
	0.09	0.18	--
	0.12	0.25	0.25
	0.18	0.37	0.37
	0.25	0.55	0.55
	0.37	0.75	0.75
	0.55	1.1	1.1
	0.75	1.5	1.5
	1.1	2.2	2.2

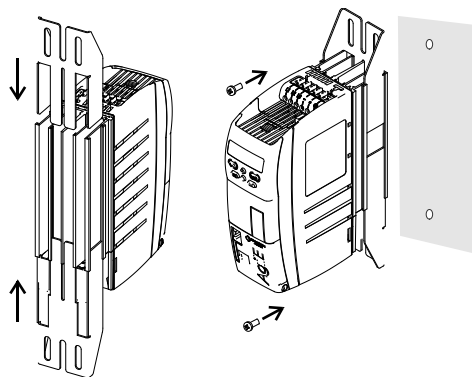
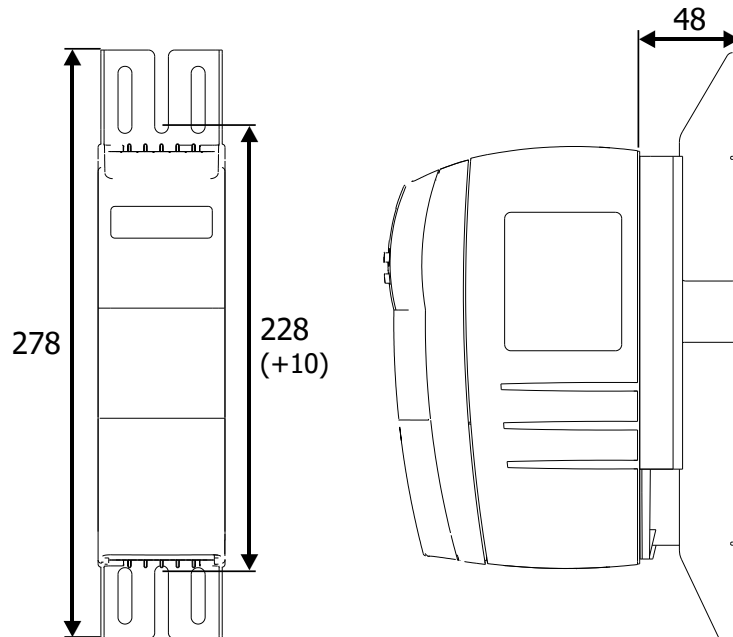

12.9.3.2 Size 2 (3~: 3.0 kW to 5.5 kW; 1.5 kW to 2.2 kW)

Frequency inverter			
Type	KFU A2		KFU A4
Mains supply	1ph.	3ph.	3ph.
Power	kW	kW	kW
	1.5	3.0	3.0
	2.2	4.0	4.0
	--	--	5.5

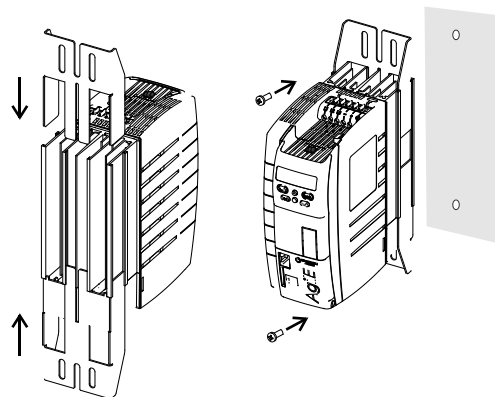
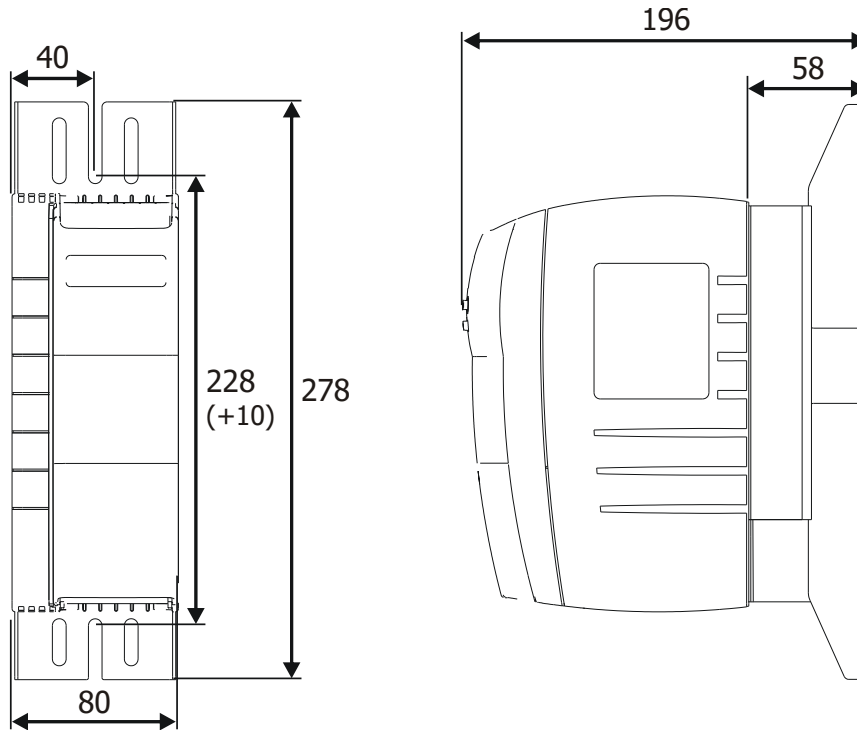

12.9.3.3 Size 3 (3~: 5.5 kW to 11.0 kW)

Valid for the following devices

Frequency inverter			
Type	KFU A2		KFU A4
Mains supply	1ph.	3ph.	3ph.
Power	kW	kW	kW
	3	5.5	5.5
	3	7.5	7.5
	--	--	9.2
	--	--	11

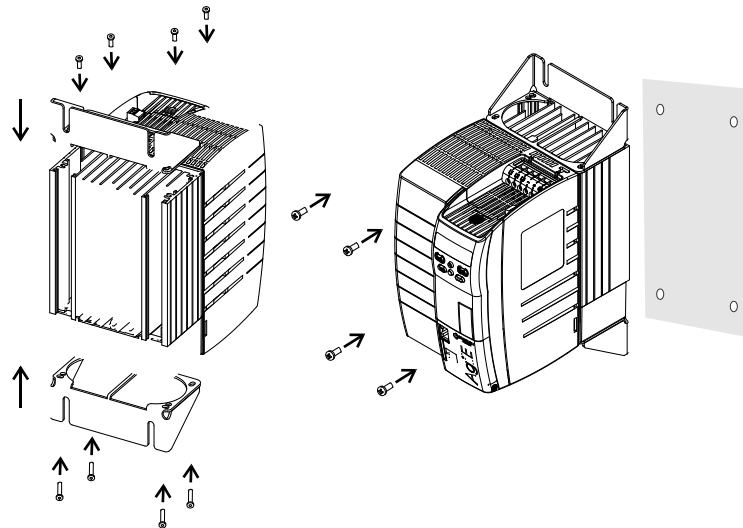
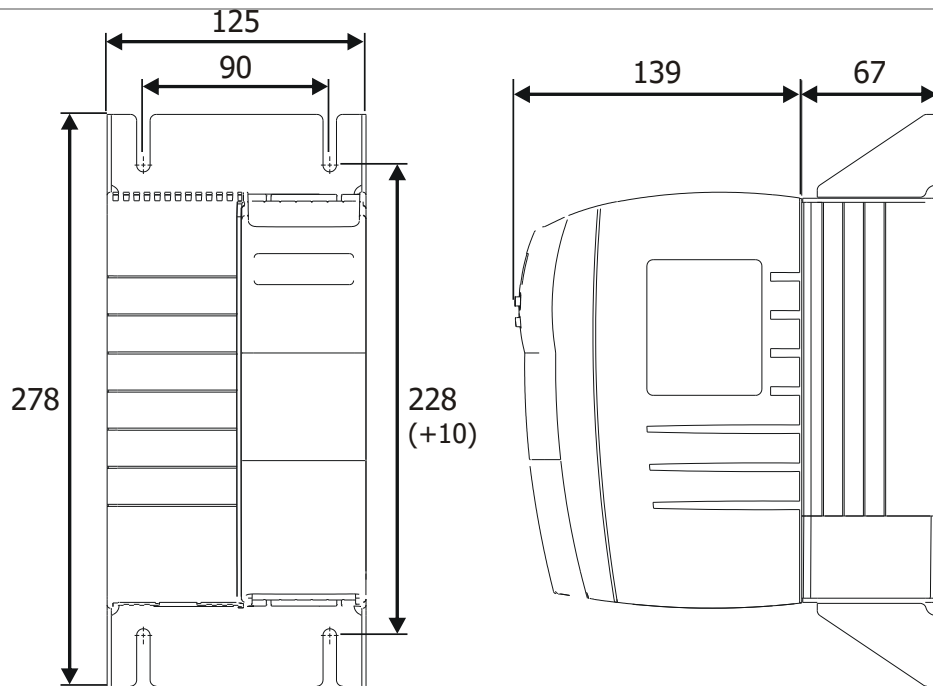

12.9.4 DIN rail (This assembly set is not included in delivery.)

Size 1 can be assembled on a DIN rail.

12.9.4.1 Size 1 (3~: 0.18 kW to 2.2 kW; 1~: 0.09 kW to 1.1 kW)

Valid for the following devices

Frequency inverter			
Type	KFU A2		KFU A4
Mains supply	1ph.	3ph.	3ph.
Power	kW	kW	kW
	0.09	0.18	0.18
	0.12	0.25	0.25
	0.18	0.37	0.37
	0.25	0.55	0.55
	0.37	0.75	0.75
	0.55	1.1	1.1
	0.75	1.5	1.5
	1.1	2.2	2.2

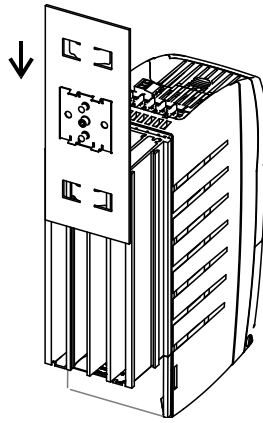

During the assembly a good contacting of the frequency inverter to the DIN rail must be assured. A good PE-connection of the frequency inverter to the assembly material and the DIN rail requires metallic conducting contact.

13 Error protocol

The various control methods and the hardware of the frequency inverter include functions which continuously monitor the application. The operational and error diagnosis is facilitated by the information stored in the error protocol.

13.1 Error list

Last errors

The last 16 fault messages are stored in chronological order and the *No. of errors* **362** shows the number of errors which have occurred since initial commissioning of the frequency inverter. On the operator panel, the error code FXXXX is displayed. The meaning of the error key is described in the following chapter "13.1.1 "Error messages". Via the PC user interface, the number of operation hours (h), operation minutes (m) and the fault message can additionally be read out. The current operating hours are shown by parameter *Operating hours counter* **245**. The error message can be acknowledged via the operator panel buttons or according to the link *Error acknowledgement* **103**.

Error list		
No.	Description	Function
310	Last Error	hhhhh:mm ; FXXXX fault message.
311	Last Error but one	hhhhh:mm ; FXXXX fault message.
312 to 325		Error 3 to error 16.
362	No. of Errors	Number of errors occurred after the initial commissioning of the frequency inverter.

363 No. of self acknowledged errors

Automatic error acknowledgment enables acknowledgment of errors Overcurrent F0507 and Overvoltage F0700 without intervention by an overriding control system or the user. The *No. of self acknowledged errors* **363** shows the total number of automatic error acknowledgments.

Error list		
No.	Description	Function
363	No. of self acknowledged Errors	Total number of automatic error acknowledgment with synchronization.

13.1.1 Error messages

259 Actual Error

Parameter *Actual Error* **259** shows the error code.

Error code

Error messages		
Code	Meaning	
F00	00	No fault has occurred.
Overload		
F01	00	Frequency inverter overloaded, check load behaviour. Reduce ramps and speed.
	01	Frequency inverter overloaded in low output frequency range.
	02	Frequency inverter overloaded (60 s), check load behaviour.
	03	Short-term overload (1 s), check motor and application parameters.
Heat Sink		
F02	00	Heat sink temperature too high, check cooling and ventilator.
	01	Heat sink temperature too cold, check allowed ambient temperature.
Inside		
F03	00	Inside temperature too high, check cooling and ventilator.
	01	Inside temperature too cold, check allowed ambient temperature.
	03	Capacitor temperature too high, check cooling and ventilator.

Error messages		
Code	Meaning	
Motor connection		
F04	00	Motor temperature too high or sensor defective, check connection at terminal X12.4.
	01	Motor circuit breaker tripped, check drive.
	02	V-belt monitoring reports no load on the drive.
	03	Phase failure, check motor and wiring.
Output current		
F05	00	Overloaded, check load situation and ramps.
	06	Motor phase current too high, check motor and wiring.
	07	Message from phase monitoring, check motor and wiring.
	08	Message from phase monitoring, check motor and wiring.
	09	Message from phase monitoring, check motor and wiring.
	11	Motor still rotates. The motor is still excited and rotates and <ul style="list-style-type: none"> - drive start command applies and the flying start function is deactivated or - a device test is tried to start
Internal Error.		
F06	xx	Internal Error. Please contact your KÜENLE office.
DC-link voltage		
F07	00	DC link voltage too high, check deceleration ramps and connected brake resistor.
	01	DC link voltage too small, check mains voltage.
	02	Power failure, check mains voltage and circuit.
	03	Phase failure mains, check mains fuses and circuit.
	04	<i>Reference DC-Link Limitation 680</i> too small, check mains voltage.
	05	Overvoltage brake chopper. Refer to chapter 13.3 "Troubleshooting" (Shut-down).
	06	Overvoltage motor chopper. Refer to chapter 13.3 "Troubleshooting" (Shut-down).
Electronics voltage		
F08	01	Electronics voltage DC 24 V too low, check control terminal.
	04	Electronics voltage too high, check wiring of control terminals.
	05	Fault in the the A/D converter. Remove all external connections (signal terminals etc.) and check if the fault remains
	06	Voltage supply for optional communication module too low. Communication via bus system faulty. Disconnect bus system wiring and acknowledge the error message. Check connections and wiring of the bus system. Replace the communication module if the error occurs, even if the bus system is disconnected. If the communication module is replaced and the error occurs, contact the service of KÜENLE.
Brake chopper		
F10	10	Brake chopper overcurrent. Also refer to chapter 7.10.4 "Brake chopper and brake resist".
Output frequency		
F11	00	Output frequency too high, check control signals and settings.
	01	Maximum frequency achieved by control. Check deceleration ramps and connected brake resistor.

Error messages			
Code	Meaning		
Enable			
F12	01	The STO Diagnosis software recognized a fault in the STO switch-off paths. Check wiring, connect screens. Check the EMC environment. If the fault remains, exchange the device.	
	02	Fault of the STO diagnosis function. If the device remains after a new start up, exchange the device.	
	04	Internal Fault. Contact the KÜENLE customer service.	
	05	Enable signals STOA and STOB were not actuated at the same time, but with a high time offset. Check the circuitry of the enable input signals.	
	06	The voltage of the STO signals is too low. Check the dimensioning of the DC 24 V supply that supplies the STO inputs.	
	07	The STO diagnosis software was not able to detect a clear defined STO level. Check the wiring and STO triggering device. Ensure, that clear signal levels can be received (DC 0 V / DC 24 V). If the fault persists, check if the fault persists with another drive.	
	08	The STO diagnosis software has recognized that the STO signal levels of the device don't correlate to each other at different measurement points. Check the wiring, put the screens on correctly. If the fault persists, exchange the device.	
	09	The STO diagnosis software recognized that an STO signal is too high inside the device. Check the wiring; apply a clear defined signal level (0V / 24 V). If the fault persists, exchange the device.	
Motor connection			
F13	00	Earth fault on output, check motor and wiring.	
	10	Minimum current monitoring, check motor and wiring.	
Control connection			
F14	01	Reference value on multifunctional input 1 faulty, check signal.	
	02	Reference value on multifunctional input 2 faulty, check signal.	
	07	Overcurrent on multifunctional input 1, check signal.	
	08	Overcurrent on multifunctional input 2, check signal.	
	09	No actual value for technology controller. Missing actual value was reported according to setting for <i>Operation mode actual value failure</i> 440 .	
	50	Temperature measurement with KTY measuring resistor defective. Check signal and measuring resistor.	
	54	External error; drive responded according to parameter setting for <i>Operation mode ext. error</i> 535 . Error was triggered via the logic signal or digital input signal assigned to parameter <i>External error</i> 183 .	
Modbus and VABus			
F20	10	Communication error according to parameter <i>X21: VABus Watchdog-Timer</i> 1502 .	
	11	Communication error according to parameter <i>CM: VABus Watchdog Timer</i> 413 .	
CANopen			
F20	21	CAN Bus OFF	
	22	CAN Guarding	
	23	Error state	
	24	SYNC error (SYNC timing)	
	25	CAN error state	
	26	RxPDO1 length error	Number of received bytes differs from mapping.
	27	RxPDO2 length error	
	28	RxPDO3 length error	
	2A	RxPDO1 Timeout	RxPDO was not received in expected time. Ensure, that the RxPDO can be received in the set up "Event time" (Subindex 5).
	2B	RxPDO2 Timeout	
	2C	RxPDO3 Timeout	

Error messages		
Code		Meaning
DeviceNet		
F20	5x	DeviceNet Fault. Please check DeviceNet manual.
Profibus		
F20	6x	Profibus Fault. Please check Profibus manual.
Internal Error.		
F20	7	Internal Error. Please contact your KÜENLE office.
System bus		
F21	nn	Fault message on system bus master when a fault at system bus slave occurs, nn = node-ID of slave (hex)
F22	00	Communication fault, system bus, timeout sync-telegram
	01	Communication fault, system bus, timeout RxPDO1
	02	Communication fault, system bus, timeout RxPDO2
	03	Communication fault, system bus, timeout RxPDO3
	10	Communication fault, system bus, bus-off
CANopen		
F23	nn	Heartbeat error, nn = triggering node.
CM module recognition		
F24	00	Unknown CM module. Check compatibility firmware and CM module.
Industrial Ethernet		
F27	nn	Industrial Ethernet Fault. Please check manual of used Ethernet module.
EtherCAT		
F28	nn	EtherCAT fault.
User Error		
F30	3n	User triggered Error of Internal PLC. Please check the application manual VPLC.
Optional components		
F0B	13	Assembly of communication module was done without disconnection of mains supply. Disconnect mains supply.
Internal monitoring		
F0C	40	After 6 warm starts in less than 3 minutes this fault is triggered, due to the expectation that a faulty programming of the PLC or the function table is at hand. Additionally the PLC / Function table is stopped (P. 1399 = 0 only in RAM).

Output signals in the case of error messages

Errors are signaled via digital signals.

162 - 3 -	Error Signal	1) 2)	A monitoring function signals an error with indication via parameter <i>Actual error</i> 259 .
--------------	--------------	----------	-------------------------------------------------------------------------------------------------------

¹⁾ For linking to frequency inverter functions.

²⁾ For output via a digital output. Select the signal source for one of the parameters 531, 532, 533, 554. See chapter 7.6.5 "Digital outputs".

In addition to fault messages mentioned, there are further fault messages. However these messages are only used for internal purposes and are not listed here. If you receive fault messages which are not listed here, please contact the KÜENLE customer service.

13.2 Error environment

Actual values at the event of a failure

The parameters of the error environment help troubleshooting both in the settings of the frequency inverter and also in the complete application. The error environment documents the operational behaviour of the frequency inverter at the time of the last four faults.

Error environment		
No.	Description	Function
330	DC-link voltage	Direct voltage in DC-link.
331	Output voltage	Calculated output voltage (motor voltage) of the frequency inverter.
332	Stator frequency	The output voltage (motor voltage) of the frequency inverter.
335	Phase current Ia	Measured current in motor phase U.
336	Phase current Ib	Measured current in motor phase V.
337	Phase current Ic	Measured current in motor phase W.
338	rms Current	Calculated effective output current (motor current) of the frequency inverter.
339	Isd/reactive current	Current component forming the magnetic flux or the calculated reactive current.
340	Isq/active current	Current component forming the torque or the calculated active current.
341	Rotor magnetizing current	Magnetizing current relative to the rated motor parameters and the operating point.
342	Torque	Torque calculated from the voltage, the current and the control variables.
343	Analog input MFI1A	Input signal at multifunction input 1 (terminal X12.3) in analog <i>Operation mode MFI1 452</i> (voltage or current).
344	Analog input MFI2A	Input signal at multifunction input 2 (terminal X12.4) in analog <i>Operation mode MFI2 562</i> (voltage or current).
346	Analog output MFO1A	Output signal at multifunction output 1 (terminal X13.6) in setting "10 - Analog (PWM) MFO1A" of parameter <i>Operation mode MFO1 (X13.6) 550</i> .
348	DC-link Cap. Temperature	Measured capacitor temperature.
349	Repetition frequency output	Signal at multifunction output 1 in setting "20 - repetition frequency (FF) MFO1F" for <i>Operation mode MFO1 (X13.6) 550</i> and according to selection for <i>RF/PT: Output Value MFO1F 555</i> .
350	Status of digital inputs	Decimally encoded status <ul style="list-style-type: none"> - of the enable signal (STOA AND STOB) - of the six digital inputs and - of multifunction input 1 (if <i>Operation mode MFI1 452</i> = "3 - digital NPN (active: 0 V)" or "4 - digital PNP (active: 24 V)") and - of multifunction input 2 (if <i>Operation mode MFI2 562</i> = "3 - digital NPN (active: 0 V)" or "4 - digital PNP (active: 24 V)").
351	Status of digital outputs	Decimally encoded status <ul style="list-style-type: none"> - of digital output at terminal X13.5. - of multifunction output at terminal X13.6 (if <i>Operation mode MFO1 (X13.6) 550</i> = "1 - Digital MFO1D" - of digital input/output at terminal X11.6 (if <i>Operation mode terminal X11.6 558</i> = "1 - output OUT3D") - of relay output at terminal X10
352	Time since release	Time of the error in hours (h), minutes (m) and seconds (s) after enable signal: hhhhh:mm:ss . ^{sec} / ₁₀ ^{sec} / ₁₀₀ ^{sec} / ₁₀₀₀ .
353	Heat sink temperature	Measured heat sink temperature.
354	Inside temperature	Measured inside temperature.
355	Controller status	The reference value signal is limited by the controller coded in the controller status.
356	Warning status	The warning messages coded in warning status.
357	Int. value 1	Software service parameter.

Error environment		
No.	Description	Function
358	Int. value 2	Software service parameter.
359	Long value 1	Software service parameter.
360	Long value 2	Software service parameter.
367	Application Warning State	The application warnings coded in warning status.

361 Checksum

The *Checksum* **361** parameter shows whether the storage of the error environment was free of errors (OK) or incomplete (NOK).

Error environment		
No.	Description	Function
361	Checksum	Check protocol of the error environment.

13.3 Troubleshooting

The list shows a selection of possible measures if problems occur. Not all problems listed will result in an error message.

Problem	Cause	Possible remedy
Error message		See chapter 13.1.1.
Shut-down	Brake resistor connection	Check.
	Brake resistance	Check value. Reduce value if necessary.
	High generator power	Reduce deceleration value.
	High DC-link voltage	Check brake resistance. Check brake resistor connection. Reduce deceleration value. Check DC-link voltage limitation (P680). DC-link voltage higher than brake chopper trigger threshold (P506). Check value. Increase value if necessary. DC-link voltage higher than motor chopper trigger threshold (P507). Check value. Increase value if necessary.
	Main phase failure	Check mains connection.
	Overcurrent	Check motor data.
	Short-circuit or overload	Check motor connection. The parameterizable motor circuit breaker (P571) has been triggered. Short-circuit at motor connection or overload.
	Earth fault	Check load for earth fault.
	Overtemperature	Overload. Reduce load and ensure sufficient cooling. Comply with permissible ambient conditions. Reduce output power or switching frequency.
	Electromagnetic interference	Check EMC.
Overfrequency	Switch-off limit (P417) exceeded. Increase value if necessary. Maximum frequency increase (P681) of DC-link voltage limitation exceeded. Increase value if necessary.	

Problem	Cause	Possible remedy	
Parameter setting not possible.	Enable is switched on and motor is running.	Most parameters cannot be written during operation. Switch off enable and select "Para" menu on operator panel.	
	Access limited.	Select higher control level (P28).	
	Setup is active.	Wait until setup is finished and the message "ready" is displayed.	
	Changes disabled by password.	Entry must correspond to password (P27).	
Motor does not turn after pressing of RUN.	Parameter setting	For P412, select "3 - Control via keypad" or "4 - Control via keypad or contacts" (factory setting). Check P418 (Minimum frequency) and P419 (Maximum frequency).	
	No enable Error in control cables	Switch on both enable inputs STOA and STOB. Check control cable connections.	
Motor does not turn after a start command at digital input.	Parameter setting	Select correct source for reference value. For example, for speed setting via a multifunction input, set at least one of parameters P475 or P492 to "1 - analog input 1" (terminal X12.3) or "2 - analog input 2" (terminal X12.4).	
	Reference value too low.	For P452 (terminal X12.3) and P562 (terminal X12.4), select the correct signal to set the reference value ("1 - voltage" or "2 - current"). For P68 (Start clockwise) or P69 (Start anticlockwise), select the required digital input. Check P418 (Minimum frequency). Set digital input for the start command to the required evaluation ("0 - NPN" or "1 - PNP"). Check actual value P228 (internal reference frequency). Check voltage or current value at reference value input.	
		No enable Error in control cables	Switch on both enable inputs STOA and STOB. Check control cable connections.
	Motor does not produce enough torque.	Carry out setup (again). Long cables will reduce the torque. V/f characteristic: Check start-up behaviour (P620), flux-formation (P780 and P781) and starting current (P623). Field-orientated control: Check start-up behaviour (flux-formation P780 and P781) and torque limit (P730), reset to factory settings if necessary.	
	Motor does not turn after a start command via a communication interface	Parameter setting	Via P412 set the controller to "1 - state machine" or "2 - remote contacts".
		No enable	Switch on both enable inputs STOA and STOB.
Motor turning in wrong direction.	Incorrect connection of motor phases.	Check motor cables. Exchange two motor phases (e.g. U and V) at the frequency inverter terminals.	

Problem	Cause	Possible remedy
Motor turning in one direction only.	Parameter setting	Connect terminals U, V and W of the frequency inverter to the corresponding terminals U, V and W of the motor. Check if P493 or P495 is set to "3 - Inverted". The reference value will be inverted. Check if for P68 (Start clockwise) and P69 (Start anti-clockwise) the required digital inputs are selected.
	Parameter setting	Check the characteristic parameters if the reference value is defined via MFI1 or MFI2 and "6 - voltage characteristic" or "7 - current characteristic" is selected.
The motor is very hot.	Load too high.	Check if P493 or P495 is set to "2 - positive only". In this case, the reference value can only be positive. Factory setting: "1 - (+/- reference value)". Check values for P420 (acceleration clockwise) and P422 (acceleration anticlockwise). The value 0.00 Hz/s blocks the corresponding direction of rotation. Reduce load. Reduce acceleration and deceleration values. Check rated current. Use larger motor.
	Motor temperature monitoring connection	Check connection of thermal contact or measuring resistance at MFI2.
Time until motor starts seems quite long	Ambient temperature too high.	Check setting of P570 (temperature evaluation). Check setting of P617 (for KTY or PT1000). Comply with permissible ambient conditions. Ensure sufficient cooling.
	Setup not carried out.	Carry out setup. For an asynchronous motor, switch to control according to V/f characteristic (set P30 to 110).
	Flying Start is used.	Switch off Flying Start (if possible, not recommended for synchronous motors). Use P.645 = 20 (if possible).
Motor stops during start-up.	Load torque too high.	Reduce load torque. Reduce acceleration values. Use larger motor.
Motor does not accelerate or motor accelerates very slowly.	Reference value too low.	Check P418 (Maximum frequency). Check acceleration and deceleration values. Set P475 and P492 to the appropriate reference frequency source. For definition of reference value via multifunction input: For P452 (terminal X12.3) and P562 (terminal X12.4), select the correct signal to set the reference value ("1 - voltage" or "2 - current").
	Ramps too smooth.	Check values for P420 (acceleration clockwise) and P422 (acceleration anticlockwise).
	Setup not carried out.	Carry out setup.
	Control according to V/f characteristic not suitable.	For high torques at low speed, field-orientated control (DMC) may be suitable. Set P30 to 410 (asynchronous motor) or 610 (synchronous motor).
	Mechanical brake	Check if a mechanical brake is effective.

Problem	Cause	Possible remedy
Speed vibrations	High load torques in the case of field-orientated control (DMC)	Check amplification and integral time settings of control functions.
	High load torques in the case of sensor-less control (V/f characteristic) PID controller	Switch on slip compensation (P660). Check parameters of V/f characteristic. If the PID controller is used, check amplification, integral time and derivative time.
	The reference value is defined via an external source.	Avoid electromagnetic interference on the control cables. Install mains and motor cables separately from the control cables. Use shielded control cables. If an analog reference value is defined: Select a filter time constant P451 for MFI1 or P561 for MFI2.
	The motor cables are too long.	Carry out setup. Shorten cables.
Overvoltage	High load torques in the case of field-orientated control (DMC)	High load torques may cause error messages due to overvoltage. For an asynchronous motor, switch to sensor-less control according to V/f characteristic (set P30 to 110).
Noise from drive	Motor noise or switching noise in frequency inverter	Reduce switching frequency (P400). Install input filter. Install output filter. Connect motor and frequency inverter to PE potential. Install mains and motor cables separately from the control cables. Avoid motor vibration.
PID controller output signal defective	Output frequency is resonant frequency of system	Set blocking frequencies (P447, P448) and hysteresis (P449) to disable output frequency ranges.
	Parameter setting	Set P475 or P492 to "30 - Technology controller". Set P476 or P494 to the source for the reference value. Set P478 to the source for the actual value. Start signal (P68 or P69) starts the PID controller.
Digital inputs have 0 V instead of a voltage of approx. 20 V	Connection	Check connection for actual value signal.
	Energy saving function	Caused by functionality (see chapter 8.3). If undesired: Deactivate Energy saving function (P1511) or select an operation mode, that doesn't switch off the I/O's.

14 Operational and error diagnosis

Operation of the frequency inverter and the connected load are monitored continuously. Various functions document the operational behaviour and facilitate the operational and error diagnosis.

14.1 Status of digital signals

350 Status Digitaleingänge

351 Status Digitalausgänge

The status display of the digital input and output signals enables checking of the various control signals and their assignment to the corresponding software functions, in particular during commissioning. Parameters *Status digital inputs* **350** and *Status digital outputs* **351** show decimal values which must be converted to binary values in order to obtain the status information.

Coding of the status of the digital signals

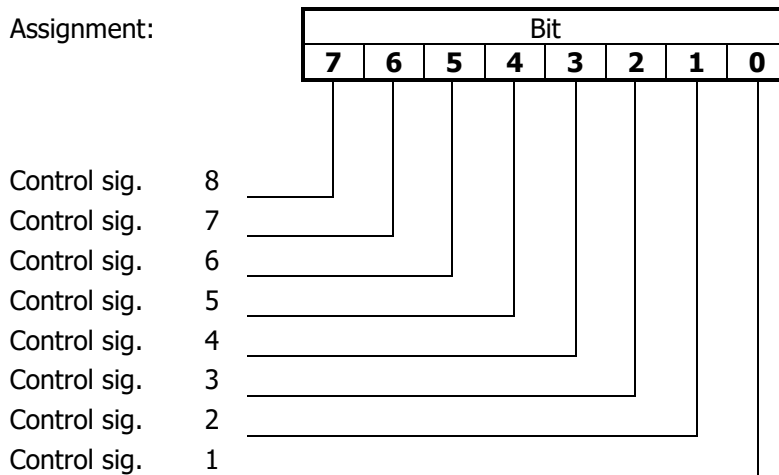

A decimal value is displayed, indicating the status of the digital signals in bits after conversion into a binary figure.

Example:

Decimal figure 33 is displayed. Converted into the binary system, the number reads 00100001. Thus, the following contact inputs or outputs are active:

Digital input or output 1

Digital input or output 6

14.2 Controller status

The controller status can be used to establish which of the control functions are active. If a several controllers are active at the time, a controller code composed of the sum total of the individual codes is displayed. Display of the controller status via the operator panel can be parameterized via parameter *Controller status message* **409**.

Coding of the controller status



Code	Controller status
C 00 00 -	No controller active.
C 00 01 UDdyn	Voltage controller is in the rise phase according to <i>Operation Mode</i> 670 .
C 00 02 UDstop	The output frequency in the case of a power failure is below the <i>Shutdown Threshold</i> 675 .
C 00 04 UDctr	Failure of the mains voltage and power regulation active according to <i>Operation Mode</i> 670 of the voltage controller.

Code	Controller status
C 00 08 UDlim	The DC link voltage has exceeded the <i>Reference DC-Link Limitation 680</i> .
C 00 10 Boost	The <i>Dyn. Voltage Pre-Control 605</i> accelerates the control characteristics.
C 00 20 Ilim	The output current is limited by the current limit value controller or the speed controller.
C 00 40 Tlim	The output power or the torque is limited by the speed controller.
C 00 80 Tctr	Switch-over of field-orientated control between speed and torque-controlled control method.
C 01 00 Rstp	The <i>Operation Mode 620</i> selected in starting behaviour limits the output current
C 02 00 IxtLtLim	Overload limit of the long-term Ixt (60 s) reached, intelligent current limits active
C 04 00 IxtStLim	Overload limit of the short-term Ixt (1 s) reached, intelligent current limits active.
C 08 00 Tclim	Max. heat sink temperature T_K reached, intelligent current limits of <i>Operation Mode 573</i> active.
C 10 00 PTclim	Max. motor temperature T_{PTC} reached, intelligent current limits of <i>Operation Mode 573</i> active.
C 20 00 Flim	Reference frequency reached the <i>Maximum Frequency 419</i> . The frequency limitation is active.

Example:

The controller status is displayed:

C0024 UDctr Ilim

The controller status results from the hexadecimal sum of the controller codes (0004+0020 = 0024). At the same, the power failure regulation and also the current limitation of the speed controller are active.

14.3 Warning status and warning status application

The current warning is displayed by a message in the warning status and can be used for an early message of a critical operational condition. Warnings are also displayed on the operator panel. If several warnings are present, the warning status is displayed as the sum of the individual warning codes.

Via the actual value parameters *Warning 269*, *Application Warnings 273*, *Warning status 356* (in error environment) and *Application warning status 367* (in error environment), all warnings present at the time of the error are displayed.

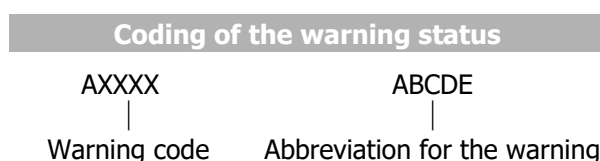

The warning masks created through parameters *Create warning mask 536* and *Create warning mask application 626* have no influence on the warnings displayed.

356 Warning Status

The parameter displays the warning at failure switch-off.

Meaning of code displayed by parameter *Warning Status 356*:

Code	Warning status
A 00 00 -	No warning message present.
A 00 01 Ixt	Frequency inverter overloaded (A0002 or A0004)
A 00 02 IxtSt	Overload for 60 s relative to the nominal output of the frequency inverter
A 00 04 IxtLt	Short-time overload for 1 s relative to the nominal output of the frequency inverter.

Code	Warning status
A 00 08 Tc	Maximum heat sink temperature T_K minus the <i>Warning Limit Heat Sink Temp.</i> 407 reached.
A 00 10 Ti	Maximum inside temperature T_i minus the <i>Warning Limit Inside Temp.</i> 408 reached.
A 00 20 Lim	The controller stated in <i>Controller Status</i> 275 limits the reference value.
A 00 40 INIT	Frequency inverter is being initialized
A 00 80 PTC	Warning behaviour according to parameterized <i>Operation Mode Motor Temp.</i> 570 at maximum motor temperature T_{Motor} .
A 01 00 Mains	<i>Phase Supervision</i> 576 reports a phase failure.
A 02 00 PMS	Motor circuit breaker parameterized in <i>Operation Mode</i> 571 tripped.
A 04 00 Flim	The <i>Maximum Frequency</i> 419 was exceeded. The frequency limitation is active.
A 08 00 A1	The input signal MFI1A is lower than 1 V / 2 mA according to the operation mode for the <i>Error/Warning Behaviour</i> 453 .
A 10 00 A2	The input signal MFI2A is lower than 1 V / 2 mA according to the operation mode for the <i>Error/Warning Behaviour</i> 563 .
A 20 00 SYS	A slave on the system bus signals an error.
A 40 00 UDC	The DC link voltage has reached the type-dependent minimum value.
A 80 00 WARN2	In <i>Application Warning State</i> 367 , a warning is present.

Example:

The following warning status is displayed:

A008D Ixt IxtLt Tc PTC

The warning status results from the hexadecimal sum of the warning codes (0001+0004+0008+0080 = 008D).

The short-term overload (1 s), warning limit heat sink temperature and warning limit motor temperature warnings are present.

Output signals

Warnings are signaled via digital signals.

169 -	general warning	1)	Signal if a message is output via <i>Warnings</i> 269 .
11 -	General warning	2)	

¹⁾ For linking to frequency inverter functions

²⁾ For output via a digital output. Select the signal source for one of the parameters 531, 532, 533, 554. See chapter 7.6.5 "Digital outputs".

273 Application Warnings

367 Application warning status

Parameter *Application Warnings* **273** displays the current warning.

Parameter *Application warning status* **367** displays the warning at failure switch-off.

Meaning of code displayed by parameters *Application Warnings* **273** and *Application Warning State* **367**:

Code	Warning status
A 00 00 NO WARNING	No warning message present.
A 00 01 BELT	Warning V-belt by Operation Mode 581 .
A 00 40 SERVICE	Service of DC link or fan required. The time remaining until next service has expired. At least for one of the parameters <i>Operation Mode Service Interval DC-link</i> 1534 or <i>Operation Mode Service Interval Fan</i> 1535 the setting "2 - Warning" is selected. <ul style="list-style-type: none"> – Service of DC-link required. The value of <i>Service Interval DC-link</i> 1530 has reached the value 0%. – Service of fan required. The value of <i>Service Interval Fan</i> 1531 has reached the value 0%.
A 00 80 User 1	The signal set on digital input <i>User Warning 1</i> 1363 is active.
A 01 00 User 2	The signal set on digital input <i>User Warning 2</i> 1364 is active.

Output signals

Application Warnings are signaled via digital signals.



$\frac{216}{26} -$	Warning, application	$\frac{1)}{2)}$	Signal if a message is output <i>Application Warnings</i> 273 .
--------------------	----------------------	-----------------	------------------------------------------------------------------------

¹⁾For linking to frequency inverter functions

²⁾For output via a digital output. Select the signal source for one of the parameters 531, 532, 533, 554. See chapter 7.6.5 "Digital outputs".

15 Parameter list

The parameter list is structured according to the menu branches of the control software. The parameters are listed in ascending numerical order. A headline (shaded) can appear several times, i.e. a subject area may be listed at different places in the table.

-  The parameter is available in the four data sets.
-  The parameter value is set by the SETUP routine.
-  The parameter cannot be written when the frequency inverter is in operation.

I_{FIN} , U_{FIN} , P_{FIN} : Nominal values of frequency inverter, o_c : Overload capacity of frequency inverter

15.1 Actual values (Menu Actual)

Actual value parameter				
No.	Description	Unit	Display range	Chapter
RS485/RS232				
11	VABus SST Error Register	-	0 ... 15	CM
Actual values of machine				
210	Stator Frequency	Hz	0.00 ... 999.99	9.2
211	rms Current	A	0.0 ... I_{max}	9.2
212	Output Voltage	V	0.0 ... U_{FIN}	9.2
213	Active Power	kW	0.0 ... P_{max}	9.2
214	Active Current	A	0.0 ... I_{max}	9.2
215	Isd	A	0.0 ... I_{max}	9.2
216	Isq	A	0.0 ... I_{max}	9.2
221	Slip Frequency	Hz	0.0 ... 999.99	9.2
Actual values of frequency inverter				
222	DC-Link Voltage	V	0.0 ... $U_{dmax}-25$	9.1
223	Modulation	%	0 ... 100	9.1
Actual values of machine				
224	Torque	Nm	\pm 9999.9	9.2
225	Rotor Flux	%	0.0 ... 100.0	9.2
226	Winding Temperature	deg.C	0 ... 999	9.2
227	Act. Rotor Time Constant	ms	0 ... τ_{max}	9.2
Actual values of frequency inverter				
228	Internal Reference Frequency	Hz	0.00 ... f_{max}	9.1
229	Reference Percentage Value	%	\pm 300.00	9.1
230	Actual Percentage Value	%	\pm 300.00	9.1
Actual value memory				
231	Peak Value Long Term Ixt	%	0.00 ... 100.00	9.4
232	Peak Value Short Term Ixt	%	0.00 ... 100.00	9.4
Actual values of machine				
235	Flux-Forming Voltage	V	0.0 ... U_{FIN}	9.2
236	Torque-Forming Voltage	V	0.0 ... U_{FIN}	9.2
238	Absolute Flux Value	%	0.0 ... 100.0	9.2
239	Reactive Current	A	0.0 ... I_{max}	9.2
240	Actual Speed	1/min	0 ... 60000	9.2
241	Actual Frequency	Hz	0.0 ... 999.99	9.2
Actual values of the system				
242	Actual System Value	Hz	0.0 ... 999.99	9.3.1
Actual values of frequency inverter				
243	Digital Inputs (Hardware)	-	00 ... 255	9.1

Actual value parameter				
No.	Description	Unit	Display range	Chapter
244	Working Hours Counter	h	99999	9.1
245	Operation Hours Counter	h	99999	9.1
246	Capacitor Temperature	deg.C	0 ... T _{emax}	9.1
249	Active Data Set	-	1 ... 4	9.1
250	Digital Inputs	-	00 ... 255	9.1
251	Analog Input MFI1A	%	± 100.00	9.1
252	Repetition Frequency Input	Hz	0.0 ... 999.99	9.1
253	Analog Input MFI2A	%	± 100.00	9.1
254	Digital Outputs	-	00 ... 255	9.1
255	Heat Sink Temperature	deg.C	0 ... T _{kmax}	9.1
256	Inside Temperature	deg.C	0 ... T _{imax}	9.1
257	Analog Output MFO1A	V	0.0 ... 24.0	9.1
258	PWM-Input	%	0.00 ... 100.00	9.1
259	Actual error	-	FXXXX	9.1
260	Actual error	-	0 ... 0xFFFF	CM
269	Warnings	-	AXXXX	9.1
270	Warnings	-	0 ... 0xFFFF (bit-coded)	CM
273	Application Warnings	-	AXXXX	9.1
274	Application Warnings	-	0 ... 0xFFFF (bit-coded)	CM
275	Controller Status	-	CXXXX	9.1
277	STO Status	-	XXXX	9.1
278	Frequency MFO1F	Hz	0.00 ... f _{max}	9.1
282	Reference Bus Frequency	Hz	-1000.00 ... 1000.00	9.1
283	Reference Ramp Frequency	Hz	0.00 ... 999.99	9.1

Note:











The parameters *Current error* **260**, *Warnings* **270** and *Application Warnings* **270** are only accessible Fieldbus. They cannot be accessed via the VPlus PC-Software or the Operator Panel.

No.	Description	Unit	Display range	Chapter
Actual value memory				
287	Peak Value Vdc	V	0.0 ... U _{dmax}	9.4
288	Average Value Vdc	V	0.0 ... U _{dmax}	9.4
289	Peak Value Heat Sink Temp.	deg.C	0 ... T _{kmax}	9.4
290	Average Value Heat Sink Temp.	deg.C	0 ... T _{kmax}	9.4
291	Peak Value Inside Temperature	deg.C	0 ... T _{imax}	9.4
292	Average Value Inside Temperature	deg.C	0 ... T _{imax}	9.4
293	Peak Value Iabs.	A	0.0 ... 0 _C ·I _{FIN}	9.4
294	Average Value Iabs	A	0.0 ... 0 _C ·I _{FIN}	9.4
295	Peak Value Active Power pos.	kW	0.0 ... 0 _C ·P _{FIN}	9.4
296	Peak Value Active Power neg.	kW	0.0 ... 0 _C ·P _{FIN}	9.4
297	Average Value Active Power	kW	0.0 ... 0 _C ·P _{FIN}	9.4
298	Peak Value Capacitor Temp.	deg.C	0 ... T _{emax}	9.4
299	Average Value Capacitor Temp.	deg.C	0 ... T _{emax}	9.4
301	Energy positive	kWh	0 ... 99999	9.4
302	Energy negative	kWh	0 ... 99999	9.4
Error list				
310	Last error	h:m; F	00000:00; FXXXX	13.1
311	Last Error but one	h:m; F	00000:00; FXXXX	13.1

No.	Description	Unit	Display range	Chapter
312	Error 3	h:m; F	00000:00; FXXXX	13.1
313	Error 4	h:m; F	00000:00; FXXXX	13.1
314	Error 5	h:m; F	00000:00; FXXXX	13.1
315	Error 6	h:m; F	00000:00; FXXXX	13.1
316	Error 7	h:m; F	00000:00; FXXXX	13.1
317	Error 8	h:m; F	00000:00; FXXXX	13.1
318	Error 9	h:m; F	00000:00; FXXXX	13.1
319	Error 10	h:m; F	00000:00; FXXXX	13.1
320	Error 11	h:m; F	00000:00; FXXXX	13.1
321	Error 12	h:m; F	00000:00; FXXXX	13.1
322	Error 13	h:m; F	00000:00; FXXXX	13.1
323	Error 14	h:m; F	00000:00; FXXXX	13.1
324	Error 15	h:m; F	00000:00; FXXXX	13.1
325	Error 16	h:m; F	00000:00; FXXXX	13.1

Error environment

	330	DC-Link Voltage	V	0.0 ... U_{dmax}	13.2
	331	Output Voltage	V	0.0 ... U_{FIN}	13.2
	332	Stator Frequency	Hz	0.00 ... 999.99	13.2
	335	Phase current Ia	A	0.0 ... I_{max}	13.2
	336	Phase current Ib	A	0.0 ... I_{max}	13.2
	337	Phase current Ic	A	0.0 ... I_{max}	13.2
	338	rms Current	A	0.0 ... I_{max}	13.2
	339	Isd / Reactive Current	A	0.0 ... I_{max}	13.2
	340	Isq / Active Current	A	0.0 ... I_{max}	13.2
	341	Rotor Magnetizing Current	A	0.0 ... I_{max}	13.2
	342	Torque	Nm	\pm 9999.9	13.2
	343	Analog Input MFI1A	%	\pm 100.00	13.2
	344	Analog Input MFI2A	%	\pm 100.00	13.2
	346	Analog Output MFO1A	V	0.0 ... 24.0	13.2
	348	DC-link Cap. Temperature	deg.C	0 ... T_{emax}	13.2
	349	Repetition Frequency Output	Hz	0.00 ... 999.99	13.2
	350	Status of Digital Inputs	-	00 ... 255	14.1
	351	Status of Digital Outputs	-	00 ... 255	14.1

No.	Description	Unit	Display range	Chapter
 352	Time since Release	h:m:s.ms	00000:00:00.000	13.2
 353	Heat Sink Temperature	deg.C	0 ... T _{kmax}	13.2
 354	Inside Temperature	deg.C	0 ... T _{imax}	13.2
 355	Controller Status	-	C0000 ... CFFFF	13.2
 356	Warning Status	-	A0000 ... AFFFF	13.2
 357	Int. Value 1	-	± 32768	13.2
 358	Int. Value 2	-	± 32768	13.2
 359	Long Value 1	-	± 2147483647	13.2
 360	Long Value 2	-	± 2147483647	13.2
 361	Checksum	-	OK / NOK	13.2
Error list				
362	No. of Errors	-	0 ... 32767	13.1
363	No. of self acknowledged Errors	-	0 ... 32767	13.1
Error environment				
 367	Application Warning State	-	A0000 ... AFFFF	14.3
Bus controller				
411	Status Word	-	0 ... 0xFFFF	7.3.1 9.7 CM
Positioning				
470	Revolutions	U	0.000 ... 1·10 ⁶	9.1
Digital outputs				
537	Actual Warning Mask	-	AXXXXXXXX	7.6.5.8
627	Actual Appl. Warning Mask	-	AXXXX	7.6.5.9
Auto set-up				
797	SETUP Status	-	OK/NOK	6.8
System bus				
978	Node-State	-	1 ... 3	9.5 Systemb.
979	CAN-State	-	1 ... 3	9.5 Systemb.
CAN bus				
1290	Node-State	-	0 ... 127	9.6 CM-CAN
1291	CAN-State	-	0 ... 4	9.6 CM-CAN
CAN bus				
1431	Module Info	-		9.8 Ethernet
Service¹				
1530	Service Interval DC-link	%	0 ... 100	10.3.1

¹ For maintenance work contact the service of KÜENLE.











No.	Description	Unit	Display range	Chapter
1531	Service Interval Fan	%	0 ... 100	10.3.2
1533	Maintenance Note	%	M----	10.3.3
Device test				
1541	Device test status	-	T----	7.2.3 9.1





















The column "chapter" refers to the chapter number and/or the corresponding document, that contains a detailed parameter description.



























- CM: Please refer to the manual of the used communication profile.
- CM-CAN: Please refer to the **CAN** communication manual.
- CM-PDPV1: Please refer to the **PROFIBUS** communication manual.
- CM-485: Please refer to the **VABus** communication manual.
- CM-Modbus: Please refer to the **Modbus** communication manual.
- Systembus: Please refer to the **Systembus** communication manual.
- Ethernet: Please refer to the **Ethernet** communication manual (i.e. Profinet, VABus/TCP, Modbus TCP).















15.2 Parameters (Menu PARA)







Parameters				
No.	Description	Unit	Setting range	Chapter
Inverter data				
0	Serial Number	-	Characters	7
1	Optional Modules	-	Characters	7
RS485/RS232				
10	CM: VABus Baud Rate	-	Selection	CM-CAN
Inverter data				
12	Inverter Software Version	-	Characters	7.1
15	Copyright	-	Characters	7.1
16	Power Module Software Version	-	Characters	7.1
27	Set Password	-	0 ... 999	7.1.3
28	Control Level	-	1 ... 3	7.1
29	User Name	-	32 characters	7
⊗	30 Configuration	-	Selection	7.1.1
⊗	34 Program(ming)	-	0 ... 9999	7.1.4
Fan				
39	Switch-On Temperature	deg.C	0 ... 60	7.10.2
Traverse function				
48	Reference Frequency	-	Selection	7.10.8
Digital inputs				
49	Handshake Traverse Function	-	Selection	7.6.6.11
62	Frequency Motorpoti Up	-	Selection	7.5.3.3.1
63	Frequency Motorpoti Down	-	Selection	7.5.3.3.1
66	Fixed Frequency Change-Over 1	-	Selection	7.6.6.5, 7.5.1.3
67	Fixed Frequency Change-Over 2	-	Selection	7.6.6.5, 7.5.1.3
68	Start Clockwise	-	Selection	7.6.6.2
69	Start Anticlockwise	-	Selection	7.6.6.2
70	Data Set Change-Over 1	-	Selection	7.6.6.11
71	Data Set Change-Over 2	-	Selection	7.6.6.11
72	PercentMotorpoti Up	-	Selection	7.5.3.3.2
73	Percent Motorpoti Down	-	Selection	7.5.3.3.2
75	Fixed Percent Change-Over 1	-	Selection	7.6.6.6
76	Fixed Percent Change-Over 2	-	Selection	7.6.6.6
81	JOG Start	-	Selection	7.5.1.6
87	Start 3-Wire Ctrl.	-	Selection	7.6.6.3
95	Brake Chopper Release	-	Selection	7.6.6.13
103	Error Acknowledgment	-	Selection	7.6.6.7
Electronic gear				
125	Source Master Reference	-	Selection	7.5.4
Digital inputs				
131	Fixed Frequency Change-Over 3	-	Selection	7.6.6.5, 7.5.1.3
Digital inputs				
164	n-/T-Control Change-Over	-	Selection	7.6.6.10
183	External Error	-	Selection	7.6.6.15
204	Thermal contact for P570	-	Selection	7.6.6.9

Parameters					
No.	Description	Unit	Setting range	Chapter	
Actual value memory					
237	Reset Memory	-	Selection	9.4	
CANopen/CAN system bus					
276	CAN Interface (CM-CAN/X12)	-	Selection	6.3.1 CM-CAN	
Rated motor parameters					
	370 Rated Voltage	V	$0.17 \cdot U_{FIN} \dots 2 \cdot U_{FIN}$	7.2	
	371 Rated Current	A	$0.01 \cdot I_{FIN} \dots 10 \cdot I_{FIN}$	7.2	
	372 Rated Speed	U/min	30 ... 60000	7.2	
<input checked="" type="checkbox"/>		373 No. of Pole Pairs	-	1 ... 24	7.2
	374 Rated Cosine Phi	-	0.01 ... 1.00	7.2	
	375 Rated Frequency	Hz	10.00 ... 1000.00	7.2	
	376 Rated Mech. Power	kW	$0.1 \cdot P_{FIN} \dots 10 \cdot P_{FIN}$	7.2	
Further motor parameters					
<input checked="" type="checkbox"/>		377 Stator Resistance	mOhm	0 ... 65535	7.2.1
<input checked="" type="checkbox"/>		378 Leakage Coeff.	%	1.0 ... 20.0	7.2.1
		383 Voltage Constant	mV/min	0.0 ... 6500.0	7.2.1
		384 Stator Inductance	mH	0.1 ... 500.0	7.2.1
CAN bus					
385	CAN Baud Rate	-	Selection	6.3.1 CM-CAN	
387	CAN Node Number	-	-1 ... 127	6.3.1 CM-CAN	
388	Error Behaviour	-	Selection	CM-CAN	
System data					
389	Factor Actual System Value	-	-100.000 ... 100.000	7.10.9	
Profibus					
391	Profibus Node-ID	-	0...126	6.3.2 CM-PDPV1	
Bus controller					
392	State transition 5	-	Selection	CM	
RS485/RS232					
394	VABus-CM Node-ID	-	1 ... 30	6.3.5	
395	Protocol (CM/X21)	-	Selection	CM-485	
Pulse width modulation					
400	Switching Frequency	-	Selection	7.10.1	
401	Min. Switching Frequency	-	Selection	7.10.1	
Error/warning behaviour					
405	Warning Limit Short Term Ixt	%	6 ... 100	7.4.1	
406	Warning Limit Long Term Ixt	%	6 ... 100	7.4.1	
407	Warning Limit Heat Sink Temp.	deg.C	-25 ... 0	7.4.2	
408	Warning Limit Inside Temp.	deg.C	-25 ... 0	7.4.2	
409	Controller-Status Message	-	Selection	7.4.3	
Bus controller					
410	Control Word	-	0 ... 0xFFFF	7.3.1 CM	
411	Status Word	-	0 ... 0xFFFF		
	412 Local/Remote	-	Selection		
RS485/RS232					
413	VABus-CM Watchdog Timer	s	0 ... 1000	CM-485	



































Parameters				
No.	Description	Unit	Setting range	Chapter
Special functions/dataset changeover				
414	Data Set Selection	-	Selection	CM
Parameters				
No.	Description	Unit	Setting range	Chapter
Error/warning behaviour				
417	Frequency Switch-off Limit	Hz	0.00 ... 599.00	7.4.4
Frequency Limits				
✓ 	418 Minimum Frequency	Hz	0.00 ... 599.00	7.5.1.1
✓ 	419 Maximum Frequency	Hz	0.00 ... 599.00	7.5.1.1
Frequency ramps				
	420 Acceleration (Clockwise)	Hz/s	0.00 ... 9999.99	7.5.1.4
	421 Deceleration (Clockwise)	Hz/s	-0.01 ... 9999.99	7.5.1.4
	422 Acceleration Anticlockwise	Hz/s	-0.01 ... 9999.99	7.5.1.4
	423 Deceleration Anticlockwise	Hz/s	-0.01 ... 9999.99	7.5.1.4
	424 Emergency Stop Clockwise	Hz/s	0.01 ... 9999.99	7.5.1.4
	425 Emergency Stop Anticlockwise	Hz/s	0.01 ... 9999.99	7.5.1.4
	426 Maximum Leading	Hz	0.01 ... 599.00	7.5.1.4
	430 Ramp Rise Time	ms	0 ... 10000	7.5.1.4
Traverse function				
	435 Operation Mode	-	Selection	7.10.8
	436 Ramp-up Time	s	0.01 ... 320.00	7.10.8
	437 Ramp-down Time	s	0.01 ... 320.00	7.10.8
	438 Traverse Amplitude	%	0.01 ... 50.00	7.10.8
	439 Proportional Step	%	0.01 ... 50.00	7.10.8
PID controller (technology controller)				
	440 Operation Mode Actual Value Failure	-	Selection	7.9.3
	441 Max. I-component	Hz	0.00 ... 599.00	7.9.3
	442 Maximum Frequency	Hz	0.00 ... 599.00	7.9.3
	443 Minimum Frequency	Hz	-599.00 ... 0.00	7.9.3
	444 Amplification	-	-15.00 ... 15.00	7.9.3
	445 Integral Time	ms	0 ... 32767	7.9.3
	446 Derivative Time	ms	0 ... 1000	7.9.3
Reference frequency channel/blocking frequencies				
	447 1st Blocking Frequency	Hz	0.00 ... 599.00	7.5.1.5
	448 2nd Blocking Frequency	Hz	0.00 ... 599.00	7.5.1.5
	449 Frequency Hysteresis	Hz	0.00 ... 100.00	7.5.1.5
Multifunction input 1 (MFI1)				
	450 Tolerance Band	%	0.00 ... 25.00	7.6.1.1.2
	451 Filter Time Constant	ms	Selection	7.6.1.1.2
	452 Operation Mode MFI1	-	Selection	7.6.1
	453 Error/Warning Behaviour	-	Selection	7.6.1.1.2
	454 Characteristic Curve Point X1	%	0.00 ... 100.00	7.6.1.1.2
	455 Characteristic Curve Point Y1	%	-100.00 ... 100.00	7.6.1.1.2
	456 Characteristic Curve Point X2	%	0.00 ... 100.00	7.6.1.1.2
	457 Characteristic Curve Point Y2	%	-100.00 ... 100.00	7.6.1.1.2





























Parameters				
No.	Description	Unit	Setting range	Chapter
Positioning				
	458 Operation Mode	-	Selection	7.3.7
	459 Signal Source	-	Selection	7.3.7
	460 Positioning Distance	U	0.000 ... 1 10 ⁶	7.3.7
	461 Signal Correction	ms	-327.68 ... 327.67	7.3.7
	462 Load Correction	-	-32768 ... 32767	7.3.7
	463 Activity after Positioning	-	Selection	7.3.7
	464 Waiting Time	ms	0 ... 3.6 10 ⁶	7.3.7
Motor potentiometer				
	473 Ramp Frequency-Motorpoti	Hz/s	0.01 ... 999.99	7.5.3.3.1
	474 Operation Mode	-	Selection	7.5.3
Frequency reference channel				
	475 Reference Frequency Source 1	-	Selection	7.5.1
Reference percentage channel				
	476 Reference Percentage Source 1	-	Selection	7.5.2
Ref. perc. val. channel/ramp				
	477 Gradient Percentage Ramp	%/s	0 ... 60000	7.5.2.4
PID controller (technology controller)				
	478 Actual Percentage Source	-	Selection	7.9.3
Fixed frequencies				
	480 Fixed Frequency 1	Hz	-599.00 ... 599.00	7.5.1.3
	481 Fixed Frequency 2	Hz	-599.00 ... 599.00	7.5.1.3
	482 Fixed Frequency 3	Hz	-599.00 ... 599.00	7.5.1.3
	483 Fixed Frequency 4	Hz	-599.00 ... 599.00	7.5.1.3
	484 Reference Frequency RAM	Hz	-599.00 ... 599.00	CM
	485 Fixed Frequency 5	Hz	-599.00 ... 599.00	7.5.1.3
	486 Fixed Frequency 6	Hz	-599.00 ... 599.00	7.5.1.3
	487 Fixed Frequency 7	Hz	-599.00 ... 599.00	7.5.1.3
	488 Fixed Frequency 8	Hz	-599.00 ... 599.00	7.5.1.3
	489 JOG Frequency	Hz	-599.00 ... 599.00	7.5.1.6
Frequency reference channel				
	492 Reference Frequency Source 2	-	Selection	7.5.1
	493 Operation Mode	-	Selection	7.5.1.2
Reference percentage channel				
	494 Reference Percentage Source 2	-	Selection	7.5.2
	495 Operation Mode	-	Selection	7.5.2.2
PWM input/repetition frequency input/pulse train				
	496 Operation mode IN2D	-	Selection	7.6.7
Repetition frequency input				
	497 Rep.Freq. : Divider	-	1 ... 8192	7.6.7.1
Brake Chopper				
	506 Trigger Threshold	V	KFU A2: 225.0 ... 1000.0 KFU A4: 325.0 ... 1000.0	7.10.4
Motor chopper				
	507 Trigger Threshold	V	KFU A2: 225.0 ... 1000.0 KFU A4: 325.0 ... 1000.0	7.10.5
Motor potentiometer				
	509 Ramp Percentage-Motorpoti	%/s	0.00 ... 600.00	7.5.3.3.2

































Parameters				
No.	Description	Unit	Setting range	Chapter
Digital outputs				
	510 Setting Frequency	Hz	0.00 ... 599.00	7.6.5.2
	517 Setting Frequency Switch Off Delta	Hz	0.00 ... 599.00	7.6.5.2
Percentage value limits				
	518 Minimum Reference Percentage	%	0.00 ... 300.00	7.5.2.1
	519 Maximum Reference Percentage	%	0.00 ... 300.00	7.5.2.1
Fixed percentages				
	520 Fixed Percentage 1	%	-300.00 ... 300.00	7.5.2.3
	521 Fixed Percentage 2	%	-300.00 ... 300.00	7.5.2.3
	522 Fixed Percentage 3	%	-300.00 ... 300.00	7.5.2.3
	523 Fixed Percentage 4	%	-300.00 ... 300.00	7.5.2.3
	524 Reference Percentage RAM	%	-300.00 ... 300.00	CM
	529 Actual Percentage RAM	%	-300.00 ... 300.00	CM
Digital outputs				
	531 Op. Mode OUT1D (X13.5)	-	Selection	7.6.5
	532 Op. Mode OUT2D (X10/Relay)	-	Selection	7.6.5
	533 Op. Mode OUT3D (X11.6)	-	Selection	7.6.5
Error/warning behaviour				
	535 Op. Mode ext. Error	-	Selection	7.4.5
	536 Create Warning Mask	-	Selection	7.6.5.8
Digital outputs				
	549 Reference Value Reached: Tolerance Band	%	0.01 ... 20.00	7.6.5.3
Multifunction output 1 (MFO1)				
	550 Operation Mode MFO1 (X13.6)	-	Selection	7.6.3
	551 Analog: Voltage 100%	V	0.0 ... 22.0	7.6.3
	552 Analog: Voltage 0%	V	0.0 ... 22.0	7.6.3
	553 Analog: Source MFO1A	-	Selection	7.6.3
	554 Digital: Source MFO1D	-	Selection	7.6.3
	555 RF/PT: Output Value MFO1F	-	Selection	7.6.3
	556 RF: Division Marks	-	30 ... 8192	7.6.3
	557 PT: Scaling Frequency	-	0 ... 32000	7.6.3
Digital input/output				
	558 Operation Mode Terminal X11.6	-	Selection	7.6.4
	559 Digital Inputs PNP/NPN	-	Selection	7.6.6
Multifunction input 2 (MFI2)				
	560 Tolerance Band	%	0.00 ... 25.00	7.6.2.1.1
	561 Filter Time Constant	-	Selection	7.6.2.1.2
	562 Operation Mode MFI2	-	Selection	7.6.1.2
	563 Error/Warning Behaviour	-	Selection	7.6.2.1.2
	564 Characteristic Curve Point X1	%	0.00 ... 100.00	7.6.2.1.1
	565 Characteristic Curve Point Y1	%	-100.00 ... 100.00	7.6.2.1.1
	566 Characteristic Curve Point X2	%	0.00 ... 100.00	7.6.2.1.1
	567 Characteristic Curve Point Y2	%	-100.00 ... 100.00	7.6.2.1.1
Error/warning behaviour				
	570 Operation Mode Motor Temp.	-	Selection	7.4.6
Motor Protection				
	571 Operation Mode	-	Selection	7.10.6
	572 Frequency Limit	%	0 ... 300	7.10.6

Parameters				
No.	Description	Unit	Setting range	Chapter
Intelligent current limits				
 573	Operation Mode	-	Selection	7.9
 574	Power Limit	%	40.00 ... 95.00	7.9
 575	Limitation Time	min	5 ... 300	7.9
Error/warning behaviour				
 576	Phase Supervision	-	Selection	7.4.7
578	Allowed No. of Auto-Acknowl.	-	0 ... 20	7.4.8
579	Restart Delay	ms	0 ... 1000	7.4.8
Pulse width modulation				
580	Reduction Limit Ti/Tc	deg.C	-25 ... 0	7.10.1
V-belt monitoring				
 581	Operation Mode	-	Selection	7.10.7
 582	Trigger Limit Iactive	%	0.1 ... 100.0	7.10.7
 583	Delay Time	s	0.1 ... 600.0	7.10.7



KFU A2- / A4-

Parameters				
No.	Description	Unit	Setting range	Chapter
V/f characteristic				
✓ 	600 Starting Voltage	V	0.0 ... 100.0	7.8
✓ 	601 Voltage Rise	%	-100 ... 200	7.8
✓ 	602 Rise Frequency	%	0 ... 100	7.8
✓ 	603 Cut-Off Voltage	V	KFU A2: 30.0 ... 280.0 KFU A4: 60.0 ... 560.0	7.8
✓ 	604 Cut-Off Frequency	Hz	0.00 ... 599.00	7.8
	605 Dyn. Voltage Pre-Control	%	0 ... 200	7.8.1
	606 Type V/f characteristic	-	Selection	7.8
I ² t Monitoring				
	608 Thermal Time Constant Motor	min	1 ... 240	7.10.6.2
	609 Thermal Time Constant Rotor	s	1 ... 600	7.10.6.2
Current limit value controller				
✓ 	610 Operation Mode	-	Selection	7.9.4.2
	611 Amplification	-	0.01 ... 30.00	7.9.4.2
	612 Integral Time	ms	1 ... 10000	7.9.4.2
	613 Current Limit	A	0.0 ... $O_c \cdot I_{FIN}$	7.9.4.2
✓ 	614 Frequency Limit	Hz	0.00 ... 599.00	7.9.4.2
I ² t Monitoring				
	615 Warning Limit Motor I²t	%	6 ... 100	7.10.6.2
PID controller (technology controller)				
	616 Backlash Motor Power of	-	Selection	7.9.3
Error/warning behaviour				
	617 Max. Temp. Motor Winding	°C	0 ... 200	7.4.6
PID controller (technology controller)				
	618 Backlash	%	0.00 ... 30.00	7.9.3
Starting behaviour				
✓ 	620 Operation Mode	-	Selection	7.3.2
	621 Amplification	-	0.01 ... 10.00	7.3.2
	622 Integral Time	ms	1 ... 30000	7.3.2
✓ 	623 Starting Current	A	0.0 ... $O_c \cdot I_{FIN}$	7.3.2
✓ 	624 Frequency Limit	Hz	0.00 ... 100.00	7.3.2
	625 Brake Release Time	ms	-5000 ... 5000	7.3.2
Warning application				
	626 Create Appl. Warning Mask	-	Selection	7.6.5.9
Stopping behaviour				
	630 Operation Mode	-	Selection	7.3.3
Direct current brake				
✓ 	631 Braking Current	A	0.00 ... $\sqrt{2} \cdot I_{FIN}$	7.3.6
	632 Braking Time	s	0.0 ... 200.0	7.3.6
✓ 	633 Demagnetizing Time	s	0.1 ... 30.0	7.3.6
	634 Amplification	-	0.00 ... 10.00	7.3.6
	635 Integral Time	ms	0 ... 1000	7.3.6
Stopping behaviour				
	637 Switch-Off Threshold Stop Function	%	0.0 ... 100.0	7.3.3
	638 Holding Time Stop Function	s	0.0 ... 200.0	7.3.3
Flying Start				
	645 Operation Mode Flying Start	-	Selection	7.3.5

Parameters				
No.	Description	Unit	Setting range	Chapter
Auto start				
651	Operation Mode	-	Selection	7.3.4
PWM input				
652	PWM Offset	%	-100.00 ... 100.00	7.6.7.1
653	PWM-Amplification	%	5.0 ... 1000.0	7.6.7.1
Pulse train				
654	Pulse Train Scaling Frequency	-	0 ... 32000	7.6.7.3
Slip compensation				
✓	 660 Operation Mode	-	Selection	7.9.4.1
	 661 Amplification	%	0.0 ... 300.0	7.9.4.1
	 662 Max. Slip Ramp	Hz/s	0.01 ... 650.00	7.9.4.1
	 663 Frequency Lower Limit	Hz	0.01 ... 599.00	7.9.4.1
Voltage controller				
	 670 Operation Mode	-	Selection	7.9.2
	 671 Mains Failure Threshold	V	-200.0 ... -50.0	7.9.2
	 672 Reference Mains Support Value	V	-200.0 ... -10.0	7.9.2
	 673 Mains Support Deceleration	Hz/s	0.01 ... 9999.99	7.9.2
	 674 Acceleration on Mains Resumption	Hz/s	0.00 ... 9999.99	7.9.2
	 675 Shutdown Threshold	Hz	0.00 ... 599.00	7.9.2
	 676 Reference Shutdown Value	V	KFU A2: 225.0 ... 387.5 KFU A4: 325.0 ... 775.0	7.9.2
	 677 Amplification	-	0.00 ... 30.00	7.9.2
	 678 Integral Time	ms	0 ... 10000	7.9.2
	 680 Reference DC-Link Limitation	V	KFU A2: 225.0 ... 387.5 KFU A4: 325.0 ... 775.0	7.9.2
	 681 Max. Frequency Rise	Hz	0.00 ... 599.00	7.9.2
	 683 Gen. Ref. Current Limit	A	0.0 ... $0_c \cdot I_{FIN}$	7.9.2
Electronic gear				
	 685 Gear Factor Numerator	-	-300.00 ... 300.00	7.5.4.3.1
	 686 Gear Factor Denominator	-	0.01 ... 300.00	7.5.4.3.1
	 687 Analog factor at 100%	-	0.00 ... 100.00	7.5.4.3.2
	 688 Analog factor at 0%	-	0.00 ... 100.00	7.5.4.3.2
	 689 Operation Mode	-	Selection	7.5.4.1
Current controller				
✓	 700 Amplification	-	0.00 ... 8.00	7.9.5.1
✓	 701 Integral Time	ms	0.00 ... 10.00	7.9.5.1
Further motor parameters				
✓	 716 Rated magnetising current	A	$0.01 \cdot I_{FIN}$... $0_c \cdot I_{FIN}$	7.2.2
Field controller				
✓	 717 Flux Reference Value	%	0.01 ... 300.00	7.9.5.5
Further motor parameters				
✓	 718 Rated Slip Correction Factor	%	0.01 ... 300.00	7.2.2
Frequency Limits				
	 719 Slip Frequency	%	0 ... 10000	7.5.1.1
Speed controller				
	 720 Operation Mode	-	Selection	7.9.5.3
✓	 721 Amplification 1(f <P738)	-	0.00 ... 200.00	7.9.5.3
	 722 Integral Time 1(f <P738)	ms	0 ... 60000	7.9.5.3
✓	 723 Amplification 2(f >P738)	-	0.00 ... 200.00	7.9.5.3

Parameters				
No.	Description	Unit	Setting range	Chapter
	724 Integral Time 2(f >P738)	ms	0 ... 60000	7.9.5.3
Acceleration pre-control				
	725 Operation Mode	-	Selection	7.9.5.4
	726 Minimum Acceleration	Hz/s	0.1 ... 6500.0	7.9.5.4
	727 Mech. Time Constant	ms	1 ... 60000	7.9.5.4
Speed controller				
	728 Current Limit	A	0.0 ... $O_c \cdot I_{FIN}$	7.9.5.3.1
	729 Current Limit Generator Op.	A	-0.01 ... $O_c \cdot I_{FIN}$	7.9.5.3.1
	730 Torque Limit	%	0.00 ... 650.00	7.9.5.3.1
	731 Torque Limit Generator Operation	%	0.00 ... 650.00	7.9.5.3.1
	732 P-Comp. Torque Upper Limit	%	0.00 ... 650.00	7.9.5.3.1
	733 P-Comp. Torque Lower Limit	%	0.00 ... 650.00	7.9.5.3.1
	734 Isq Limit Source Motor Op.	-	Selection	7.9.5.3.2
	735 Isq Limit Source Generator Op.	-	Selection	7.9.5.3.2
	736 Torque Limit Source Motor Op.	-	Selection	7.9.5.3.2
	737 Torque Limit Source Gen. Op.	-	Selection	7.9.5.3.2
<input checked="" type="checkbox"/> 	738 Speed Control Switch-Over Limit	Hz	0.00 ... 599.00	7.9.5.3
	739 Power Limit	kW	0.00 ... $2 \cdot O_c \cdot P_{FIN}$	7.9.5.3.1
	740 Power Limit Generator Operation	kW	0.00 ... $2 \cdot O_c \cdot P_{FIN}$	7.9.5.3.1
Field controller				
	741 Amplification	-	0.0 ... 100.0	7.9.5.5
<input checked="" type="checkbox"/> 	742 Integral Time	ms	0.0 ... 1000.0	7.9.5.5
<input checked="" type="checkbox"/> 	743 Ref. Isd Upper Limit	A	0.0 ... $O_c \cdot I_{FIN}$	7.9.5.5.1
<input checked="" type="checkbox"/> 	744 Ref. Isd Lower Limit	A	$-I_{FIN}$... I_{FIN}	7.9.5.5.1
Current controller				
	746 Cross-Coupling Factor	%	0.00 ... 300.00	7.9.5.1
Speed controller				
	748 Backlash Damping	%	0 ... 300	7.9.5.3
Modulation controller				
	750 Reference Modulation	%	3.00 ... 105.00	7.9.5.6
	752 Integral Time	ms	0.0 ... 1000.00	7.9.5.6
	753 Operation Mode	-	Selection	7.9.5.6
	755 Reference Imr Lower Limit	A	$0.01 \cdot I_{FIN}$... $O_c \cdot I_{FIN}$	Fehler! Verweis- quelle konnte nicht ge- funden werden.
	756 Control Deviation Limitation	%	0.00 ... 100.00	Fehler! Verweis- quelle konnte nicht ge- funden werden.
Torque controller				
	767 Frequency Upper Limit	Hz	-599.00 ... 599.00	7.9.5.2.2
	768 Frequency Lower Limit	Hz	-599.00 ... 599.00	7.9.5.2.2
	769 Frequency upper limit source	-	Selection	7.9.5.2.3
	770 Frequency lower limit source	-	Selection	7.9.5.2.3

Parameters					
No.	Description	Unit	Setting range	Chapter	
Starting behaviour					
<input checked="" type="checkbox"/>	<input type="checkbox"/>	779 Min. Flux-Formation Time	ms	1 ... 10000	7.3.2
<input checked="" type="checkbox"/>	<input type="checkbox"/>	780 Max. Flux-Formation Time	ms	1 ... 10000	7.3.2
<input checked="" type="checkbox"/>	<input type="checkbox"/>	781 Current during Flux-Formation	A	0.1·I _{FIN} ... 0 _c ·I _{FIN}	7.3.2
Auto set-up					
796	SETUP Selection	-	Selection	6.8	
System bus					
900	Node-ID	-	-1 ... 63	6.3.3 Systemb.	
903	Baud-Rate	-	Selection	6.3.3 Systemb.	
904	Boot-Up Delay	ms	3500 ... 50000	Systemb.	
918	SYNC-Identifier	-	0 ... 2047		
919	SYNC-Time	ms	0 ... 50000		
921	RxSDO1-Identifier	-	0 ... 2047		
922	TxSDO1-Identifier	-	0 ... 2047		
923	SDO2 Set Active	-	Selection		
924	RxPDO1 Identifier	-	0 ... 2047		
925	TxPDO1 Identifier	-	0 ... 2047		
926	RxPDO2 Identifier	-	0 ... 2047		
927	TxPDO2 Identifier	-	0 ... 2047		
928	RxPDO3 Identifier	-	0 ... 2047		
929	TxPDO3 Identifier	-	0 ... 2047		
930	TxPDO1 Function	-	Selection		
931	TxPDO1 Time	ms	0 ... 50000		
932	TxPDO2 Function	-	Selection		
933	TxPDO2 Time	ms	0 ... 50000		
934	TxPDO3 Function	-	Selection		
935	TxPDO3 Time	ms	0 ... 50000		
936	RxPDO1 Function	-	Selection		
937	RxPDO2 Function	-	Selection		
938	RxPDO3 Function	-	Selection		
939	SYNC Timeout	ms	0 ... 60000		
941	RxPDO1 Timeout	ms	0 ... 60000		
942	RxPDO2 Timeout	ms	0 ... 60000		
945	RxPDO3 Timeout	ms	0 ... 60000		
946	TxPDO1 Boolean1	-	Selection		
947	TxPDO1 Boolean2	-	Selection		
948	TxPDO1 Boolean3	-	Selection		
949	TxPDO1 Boolean4	-	Selection		
950	TxPDO1 Word1	-	Selection		
951	TxPDO1 Word2	-	Selection		
952	TxPDO1 Word3	-	Selection		
953	TxPDO1 Word4	-	Selection		
954	TxPDO1 Long1	-	Selection		
955	TxPDO1 Long2	-	Selection		
956	TxPDO2 Boolean1	-	Selection		
957	TxPDO2 Boolean2	-	Selection		
958	TxPDO2 Boolean3	-	Selection		

Parameters				
No.	Description	Unit	Setting range	Chapter
959	TxPDO2 Boolean4	-	Selection	Systemb.
960	TxPDO2 Word1	-	Selection	
961	TxPDO2 Word2	-	Selection	
962	TxPDO2 Word3	-	Selection	
963	TxPDO2 Word4	-	Selection	
964	TxPDO2 Long1	-	Selection	
965	TxPDO2 Long2	-	Selection	
966	TxPDO3 Boolean1	-	Selection	
967	TxPDO3 Boolean2	-	Selection	
968	TxPDO3 Boolean3	-	Selection	
969	TxPDO3 Boolean4	-	Selection	
972	TxPDO3 Word1	-	Selection	
973	TxPDO3 Word2	-	Selection	
974	TxPDO3 Word3	-	Selection	
975	TxPDO3 Word4	-	Selection	
976	TxPDO3 Long1	-	Selection	
977	TxPDO3 Long2	-	Selection	
989	Emergency Reaction	-	Selection	
1180	Operation Mode	-	Selection	
Further motor parameters				
	1190 Stator Resistance	Ohm	0.001 ... 100.000	7.2.1
	1192 Peak Current	A	0.01% I _{FIN} ... 100000% O _c I _{FIN}	7.2.1
Mux/DeMux				
1250 Mux Input Index (write)	-	EEPROM: 0 ... 16 RAM: 17 ... 33	7.6.6.17	
1251 Mux Input Index (read)	-	EEPROM: 0 ... 16 RAM: 17 ... 33	7.6.6.17	
1252 Mux Inputs	-	Selection	7.6.6.17	
1253 DeMux Input	-	Selection		
User warnings				
1363 User warning 1	-	Selection	7.6.6.14	
1364 User warning 2	-	Selection	7.6.6.14	
Convert PDP/internal				
1370 In-F-PDP-word1	-	Selection	7.10.12	
1371 In-F-PDP-word2	-	Selection	7.10.12	
1372 In-F-intern-long1	-	Selection	7.10.12	
1373 In-F-intern-long2	-	Selection	7.10.12	
1374 Convert-Reference	Hz	0.01 Hz...599.00 Hz	7.10.12	
Modbus (RTU/ASCII)				
1375 Modbus Parity	-	Selection	6.3.4	
1376 Modbus Address	-	1 ... 247	CM-Modbus	
CANopen				
1414	CANopen 0x3008 Perc. Actual Value Source	-	Selection	
1415	CANopen 0x3011 Act.ValueWord 1	-	Selection	
1416	CANopen 0x3012 Act.ValueWord 2	-	Selection	
1417	CANopen 0x3021 Act.ValueLong 1	-	Selection	
1418	CANopen 0x3022 Act. ValueLong 2	-	Selection	
1420	CANopen Mux Input Index (write)	-	EEPROM: 0 ... 16 RAM: 17 ... 33	
1421	CANopen Mux Input Index (read)	-	EEPROM: 0 ... 16	

Parameters				
No.	Description	Unit	Setting range	Chapter
			RAM: 17 ... 33	
1422	CANopen Mux Inputs	-	Selection	CM-CAN
1423	CANopen Obj 0x3007 Actual Percentage Value Source	-	Selection	
1451	OS Synctime	-	700 ... 900	
CANopen				
1432	IP Address	-	nnn.nnn.nnn.nnn	Ethernet
1433	Netmask	-	nnn.nnn.nnn.nnn	
1434	Gateway	-	nnn.nnn.nnn.nnn	
1435	DNS Server	-	nnn.nnn.nnn.nnn	
1436	DHCP Option	-	Selection	
1437	IP Command	-	Selection	
1438	Reload IP-Settings	-	0 ... 1	
1440	Email function	-	Selection	
1441	Email Text (Body)	-	Text	
VABus (X21)				
1500	VABus-X21 Baud rate	-	Selection	6.3.5
1501	VABus-X21 Node-ID	-	1 ... 30	CM-485
1502	VABus-X21 Watchdog Timer	s	0 ... 1000	CM-485
Modbus (RTU/ASCII)				
1503	Modbus Mode	-	Selection	6.3.4
1504	Modbus Baud rate	Baud	Selection	CM-Modbus
1505	Modbus Watchdog Timer	s	0 ... 1000	CM-Modbus
Standby				
1510	Time until Keypad Standby	Min	0 ... 60	8.3
1511	Standby Mode	-	Selection	8.3
Real-time tuning				
1520	Operation Mode Real-Time Tuning	-	Selection	7.9.6
Service ¹⁾				
1534	Operation Mode Service Interval DC-link	-	Selection	10.3.1
1535	Operation Mode Service Interval Fan	-	Selection	10.3.2
1539	Reset Service Intervals	-	Selection	10.3.3
Device test				
1540	Start device test manual	-	Selection	7.2.3.3 7.2.3.4
1542	Start device test automatic	-	Selection	7.2.3.5
1543	Base Parameter Actual System Value	-	0 ... 1600	7.10.9
Energy saving function				
1550	Operation Mode Energy Saving Function	-	Selection	8.1
1551	Flux Reduction	%	0 ... 100	8.1
1552	Energy Saving FunctionOn	-	Selection	8.1

1) For maintenance work contact the service of KÜENLE.

The column "chapter" refers to the chapter number and/or the corresponding document that contains a detailed parameter description.

CM: Please refer to the manual of the used communication profile.

CM-CAN: Please refer to the **CAN** communication manual.

CM-PDPV1: Please refer to the **PROFIBUS** communication manual.

CM-485: Please refer to the **VABus** communication manual.
CM-Modbus: Please refer to the **Modbus** communication manual.
Systembus: Please refer to the **Systembus** communication manual.
Ethernet: Please refer to the **Ethernet** communication manual (i.e. Profinet, VABus/TCP, Modbus TCP).

Index

- A**
- Acceleration (Ramps) 142
 - Acceleration pre-control 233
 - Acknowledge error messages 198
 - automatic 137
 - via keypad 92
 - via logic signal 197
 - via Parameter 34 Program(ming) 107
 - Actual values
 - memory 264
 - of frequency inverter 261
 - of machine 263
 - of system 264
 - Adaptor USB 303
 - Analog inputs 79
 - Analog outputs 79
 - Assembly
 - Cold Plate
 - size 1 314
 - size 2 315
 - size 3 316
 - DIN rail
 - size 1 319
 - Feed-through
 - size 1 305
 - size 2 307
 - size 3 308
 - Standard
 - size 1 22
 - size 2 23
 - size 3 24
 - Vibration-proof
 - size 1 317
 - size 2 318
 - size 3 318
 - Auto set-up 102
 - Auto start 124

B

 - Blocking frequencies 145
 - Blocking Frequencies 81
 - Brake
 - Control via digital output 187
 - Direct current brake 126
 - Brake chopper 238
 - Release 200
 - Brake resistor 238
 - connection 34
 - dimensioning 239

C

 - Cable length 33, 34
 - CANopen 70
 - CE conformity 272
 - Cold Plate 310
 - size 1 314
 - size 2 315
 - size 3 316
 - Commissioning 44
 - Communication 92
 - modules 303
 - Setup 48, 69
 - Compressor, Application example 99
 - Conductor cross-section 28
 - Configuration 105
 - Connection 26
 - Control 116
 - Control functions 208
 - Intelligent current limits 208
 - PID 216
 - Power failure regulation 213
 - Voltage controller 210
 - Control level 105
 - Control panel
 - Lock 117, 139, 149, 157, 158
 - Control signals 192
 - Control terminals
 - Setting options 40
 - Standard settings 36
 - Conveying plant, Application example 98
 - Copy parameter values 250
 - Copying with Memory Card
 - Warning message 252
 - Copyright 7
 - Current controller 225
 - Current limit value controller 224
 - Current limitation 188

D

 - Data set 88, 199
 - changeover 198
 - Deceleration (Ramps) 142
 - Decommissioning 16
 - Demultiplexer 201
 - Designated use 9
 - Device test 112
 - Diagnosis 330
 - Digital input 2
 - Operation mode 203
 - Pulse train 205
 - PWM 204
 - Repetition frequency 205
 - Digital input/output 182
 - Digital inputs 78, 192
 - Evaluation logic 41, 182, 192
 - Logic signal 192
 - Digital outputs 78, 183
 - Logic signals 183
 - Dimensions 21
 - DIN rail 319
 - size 1 319
 - Direct current brake 126
 - Direction of rotation 142, 150
 - Check 64
 - Start clockwise, start anticlockwise 195

<p>DMC (Direct Moment Control) 105</p> <p>E</p> <p>Electrical connection 26</p> <p>Electrical connections 14</p> <p>Electrical Installation..... 25</p> <p style="padding-left: 20px;">Safety 25</p> <p>Electronic gear 89, 159</p> <p style="padding-left: 20px;">Actual value..... 162</p> <p style="padding-left: 20px;">Gear factor 161</p> <p style="padding-left: 20px;">Offset..... 162</p> <p style="padding-left: 20px;">Operation modes 159</p> <p>EMC 26</p> <p>Emergency stop 143</p> <p>Enable</p> <p style="padding-left: 20px;">Status of inputs 262</p> <p>Energy saving 91, 254</p> <p>Energy saving function 254</p> <p>Error behaviour 130</p> <p>Error environment 324</p> <p>Error list 321</p> <p>Error message</p> <p style="padding-left: 20px;">Memory card copying 252</p> <p>Error messages 321</p> <p style="padding-left: 20px;">of auto-setup..... 63</p> <p>Error protocol..... 321</p> <p>Error/Warning behaviour</p> <p style="padding-left: 20px;">Multifunction input 1 169</p> <p style="padding-left: 20px;">Multifunction input 2 176</p> <p>External error.....132, 200</p> <p>External fan 188</p> <p>External power supply 42</p> <p>F</p> <p>Factory reset</p> <p style="padding-left: 20px;">Complete reset 107</p> <p>Factory setting</p> <p style="padding-left: 20px;">single parameter via keypad 52</p> <p>Fan</p> <p style="padding-left: 20px;">external..... 188</p> <p style="padding-left: 20px;">Switch-On Temperature..... 237</p> <p>Fan, Application example94, 95, 97</p> <p>Feed-through</p> <p style="padding-left: 20px;">size 1 305</p> <p style="padding-left: 20px;">size 2 307</p> <p style="padding-left: 20px;">size 3 308</p> <p>Feed-through assembly 304</p> <p>Field bus..... 92</p> <p>Field controller 233</p> <p>Field-orientated control</p> <p style="padding-left: 20px;">Asynchronous motor 105</p> <p style="padding-left: 20px;">Synchronous motor 105</p> <p>Filter time constant 176</p> <p style="padding-left: 20px;">Multifunction input 1 169</p> <p style="padding-left: 20px;">Multifunction input 2 176</p> <p>Fixed Frequencies..... 81</p> <p>Fixed frequency..... 140</p> <p style="padding-left: 20px;">Changeover142, 197</p> <p>Fixed percentage..... 149</p> <p style="padding-left: 20px;">Changeover150, 197</p> <p>Flux forming finished 187</p> <p>Flux reduction 255</p>	<p>Flying Start..... 124</p> <p>Frequency</p> <p style="padding-left: 20px;">Limits 139</p> <p style="padding-left: 20px;">Ramps 142</p> <p>Frequency Limit 244</p> <p>Function table..... 201</p> <p>G</p> <p>Gear factor 161</p> <p style="padding-left: 20px;">fixed 161</p> <p style="padding-left: 20px;">variable..... 161</p> <p>General information about the documentation 5</p> <p>Group drive 34</p> <p>H</p> <p>Hysteresis 145</p> <p style="padding-left: 20px;">Frequency hysteresis 145</p> <p style="padding-left: 20px;">of analog input signal 168, 175</p> <p>I</p> <p>Installation 14, 21</p> <p style="padding-left: 20px;">mechanical..... 21</p> <p>Intelligent current limits 208</p> <p>J</p> <p>JOG 52, 146</p> <p style="padding-left: 20px;">Start 197</p> <p>K</p> <p>Keypad..... 45</p> <p>KTY 135</p> <p>L</p> <p>Leading 144</p> <p>M</p> <p>Machine data..... 108</p> <p>Mains Connection 27, 30</p> <p>Maintenance..... 267</p> <p style="padding-left: 20px;">DC-link 269</p> <p style="padding-left: 20px;">Fan..... 270</p> <p>Master drive, Traverse function 247</p> <p>Maximum frequency..... 140</p> <p>Mechanical installation</p> <p style="padding-left: 20px;">Safety..... 21</p> <p>Memory card 303</p> <p>Menu 45</p> <p>Minimum frequency 140</p> <p>Modbus..... 72</p> <p>Modulation controller 235</p> <p>Monitoring</p> <p style="padding-left: 20px;">Analog input signal 169, 176</p> <p style="padding-left: 20px;">Controller intervention 131</p> <p style="padding-left: 20px;">Effective current..... 247</p> <p style="padding-left: 20px;">Heat sink temperature 130</p> <p style="padding-left: 20px;">Inside temperature..... 130</p> <p style="padding-left: 20px;">Load behaviour 247</p> <p style="padding-left: 20px;">Motor temperature 132, 198</p> <p style="padding-left: 20px;">Output frequency 131</p> <p style="padding-left: 20px;">Overload..... 130</p> <p style="padding-left: 20px;">Phase failure 136</p> <p style="padding-left: 20px;">Warning mask 188</p> <p style="padding-left: 20px;">Warning mask application 191</p> <p>Monitoring functions 90</p> <p>Motor chopper 240</p> <p>Motor connection 32</p> <p>Motor data 108</p>
---------------------------------------------------------------------------------------------------------------------------------------------------------------------------------------------------------------------------------------------------------------------------------------------------------------------------------------------------------------------------------------------------------------------------------------------------------------------------------------------------------------------------------------------------------------------------------------------------------------------------------------------------------------------------------------------------------------------------------------------------------------------------------------------------------------------------------------------------------------------------------------------------------------------------------------------------------------------------------------------------------------------------------------------------------------------------------------------------------------------------------------------------------------------------------------------------------------------------------------------------------------------------------------------------------------------------------------------------------------------------------------------------------------------------------------------------------------------------------------------------------------------------------------------------------------------------------------------------------------------------------------------------------------------------------------------------------------------------------------------------------------------------------------------------------------------------------------------------------------------------------------------------------------------------------------------------------------------------------------------------------------------------------------------------------------------------------------------------------------------------------------------------------------------------------------------------------------------------------------------------------------------------------------------------------------------------------------------------------------------------------------------------------------------------------------------------------------------------------------------------------------------------------------------------------------------------------------------------------------------------------	-------------------------------------------------------------------------------------------------------------------------------------------------------------------------------------------------------------------------------------------------------------------------------------------------------------------------------------------------------------------------------------------------------------------------------------------------------------------------------------------------------------------------------------------------------------------------------------------------------------------------------------------------------------------------------------------------------------------------------------------------------------------------------------------------------------------------------------------------------------------------------------------------------------------------------------------------------------------------------------------------------------------------------------------------------------------------------------------------------------------------------------------------------------------------------------------------------------------------------------------------------------------------------------------------------------------------------------------------------------------------------------------------------------------------------------------------------------------------------------------------------------------------------------------------------------------------------------------------------------------------------------------------------------------------------------------------------------------------------------------------------------------------------------------------------------------------------------------------------------------------------------------------------------------------------------------------------------------------------------------------------------------------------------------------------------------------------------------------------------------------------------------------------------------------------------------------------------------------------------------------------------------------------------------------------------------------------------------------------------------------------------------------------------------------------------------------------------------------------------------

Motor potentiometer.....	80, 151, 196	Positioning	127
control via digital inputs	152	Poti F	49
control via operator panel.....	156	Poti P	51
Motor Protection.....	242	Power failure regulation	213
motor circuit breaker.....	242	Profibus	70
Motor Protection by I ² t- Monitoring	245	Protective functions	90
Mounting	21	PT1000	136
Multifunction input	164	PTC.....	135
Multifunction input 1		Pulse train	
Characteristic.....	166	Input	205
Error/Warning behaviour	169	Output.....	181
Filter time constant	169	Pulse train input	82
set as analog input.....	164	Pulse width modulation	236
set as digital input.....	170	Pump, Application example.....	93, 95
Tolerance band.....	168	PWM input	81, 204
Multifunction input 2		R	
Characteristic.....	172	Ramp	
Error/Warning behaviour	176	Frequency.....	142
Filter time constant	176	Percentage.....	151
set as analog input.....	171	Ramp rise time	144
set as digital input.....	177	Rated motor parameters	108
Tolerance band.....	175	Reference frequency	76
Multifunction output	178	inverted	140
Analog.....	179	Reference frequency channel.....	137
Characteristic.....	178	Reference percentage	
Digital	180	inverted	149
Operation mode.....	178	Reference percentage channel.....	147
Pulse train	181	Reference torque.....	87
Repetition frequency	180	Reference value.....	137
Multiplexer	201	Fixed frequency.....	140
N		Fixed percentage.....	149
NPN.....	41, 182, 192	JOG frequency	146
O		Motor potentiometer.....	151
OC (overload capacity)	272	Reached	186
Operator panel.....	45	Release brake.....	187
Menu.....	45	Repetition frequency (RF)	
Options.....	285	Input	205
Assembly		Output.....	180
Variants	304	Repetition frequency input	82
Brake resistor	291	Resource pack.....	303
Communication module	303	S	
DIN rail	319	SA Warning messages auto set-up.....	61
Input filter	296	Safety	
Line choke.....	292	Electrical Installation.....	25
Resource pack	303	General.....	8
Shield sheet.....	285	mechanical installation	21
USB adaptor	303	S-curve	144
Overload capacity.....	272	Service.....	16, 267
P		Setting frequency	185
Parameter		Setup.....	53
Copy	250	Asynchronous motor via operator panel ...	54
List.....	334	Communication	69
Password	107	Synchronous motor via operator panel.....	57
Percentage		SF Error messages auto-setup	63
Limits	149	Shield sheet	285
Ramps.....	151	Slave drive, traverse function	247
Reference value	147	Slip compensation.....	223
PID controller.....	216	Speed control	77
PLC	201	Speed controller	229
PNP	41, 182, 192	Switch-over speed/torque control	198

SS Status messages auto-setup..... 61	Type designation 18
Standby mode..... 257	U
Start anticlockwise..... 195	UL Approval.....272
Start clockwise 195	USB adaptor303
Starting behaviour 118	User Name104
FOC 84	User warning200
Starting behaviour's/f 83	V
Status device test..... 114	V/f105
Stopping behaviour 84, 122	Characteristic207
Storage..... 14	Linear.....207
Switching frequency 236	Quadratic256
Synchronization..... 124	V/f characteristic..... 85
System data 250	V/f Starting behaviour 83
Systembus 71	VABus 73
T	Vibration-proof
TCP/IP..... 74	size 1.....317
Technical data..... 272	size 2.....318
Technology controller 216	size 3.....318
Thermal time constant motor 246	Voltage controller210
Thermal time constant rotor..... 246	Voltage input..... 42
Thermocontact..... 198	W
Three-wire control..... 195	Warning behaviour.....130
Tolerance band168, 175	Warning code
Multifunction input 1 168	of warning mask.....190
Multifunction input 2 175	of warning mask application.....191
Torque	Warning limit motor I ² t246
Control 227	Warning mask188
Control, Application example..... 101	Warning mask, application191
Reference value 87	Warning message
Torque control 77	Memory card copying252
Transport..... 14	Warning messages.....331
Travel application, Application example..... 100	of auto set-up 61
Traverse function 247	Warning status331
Handshake 200	Warranty and liability 6